

因應老化後之無障礙住宅設計

王武烈建築師 115.06.16

現任：台北市建築師公會第17屆理事

台北市政府公共建築物行動不便者使用設施
改善諮詢及審查小組委員

中華民國全國建築師公會第16屆監事

內政部國土署無障礙生活環境業務督導委員

曾任：台北市、台灣省建築師公會歷屆理、監事

中華民國建築師公會全國聯合會歷屆理、監事

行政院社會福利推動委員會第5屆委員

內政部營建署無障礙生活環境業務督導委員

台北市無障礙環境推動委員會委員

服務及保護社會大眾的責任

- 「專業」是指一種需要特別養成或教育過程、運用特定領域和知識的專責工作，不僅能為社會帶來貢獻，也受到社會尊重。
- 利用所學之專業知識及素養提供服務，積極地結合群體的智慧與能力，善盡社會責任，達成增進社會福祉的目的。

台灣銀髮族環境需求

- 亞洲地區台灣、日本、韓國是人口老化速度最快的國家。根據推估台灣65歲人口比率在2010年10.76%；2014年12 %；2017年14%(高齡)；2025年20%(超高齡)；2033年是全世界最老化的國家；2043年34% 2051年37%。
- 行政院於2007年開始展開的十年長照計畫是為了：建構一個符合多元化、社區化（普及化）、優質化、可負擔及兼顧性別、城鄉、族群、文化、職業、經濟、健康條件差異之長期照顧制度。
- 充實居家式及社區式照顧資源，落實在地老化。

老化社會



終於有一天



快速老化的時代



老人社會正式來臨



2025年台灣人口金字塔圖

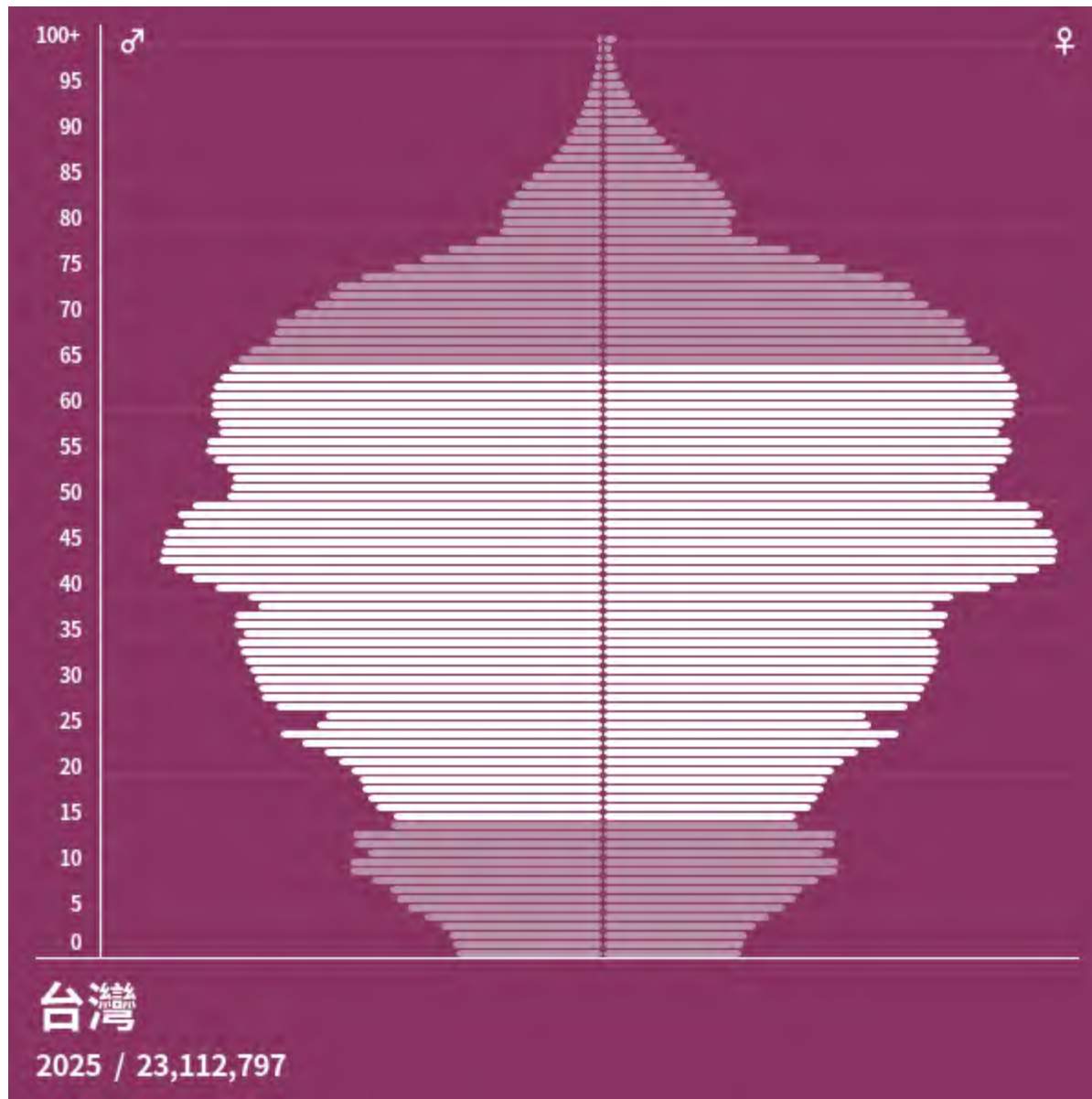

人類老化有：

生理性老化：是**組織器官**的衰退，如呼吸、循環、消化等器官的衰退。

心理性老化：是對**環境適應**能力的減退，有遲鈍、健忘、失智、錯亂或無安全感等。

社會性老化：是**社會活動**的引退，如退休、離婚、喪偶、脫友、讓權等。

1-0. 高齡化社會

1-1. 老人的定義

1-2. 少子女化現象

1-3. 長壽化現象

1-4. 高齡化速度

對老人衰老後應有的考量

- **視覺問題**：白內障、青光眼、網膜病變、黃斑病變、屈光異常、糖尿病、高血壓，不適應強光、眩光、視野減小。
- **聽覺問題**：聽力障礙、平衡功能降低。
- 對於馬桶、淋浴、扶手高度、門把位置、樓梯梯級之級高及級深、電話與警示裝置的高度，都必須考量老年人的身體尺寸、伸手可及的範圍，以及生活習慣都應該顧慮到。

1-1. 老人的定義

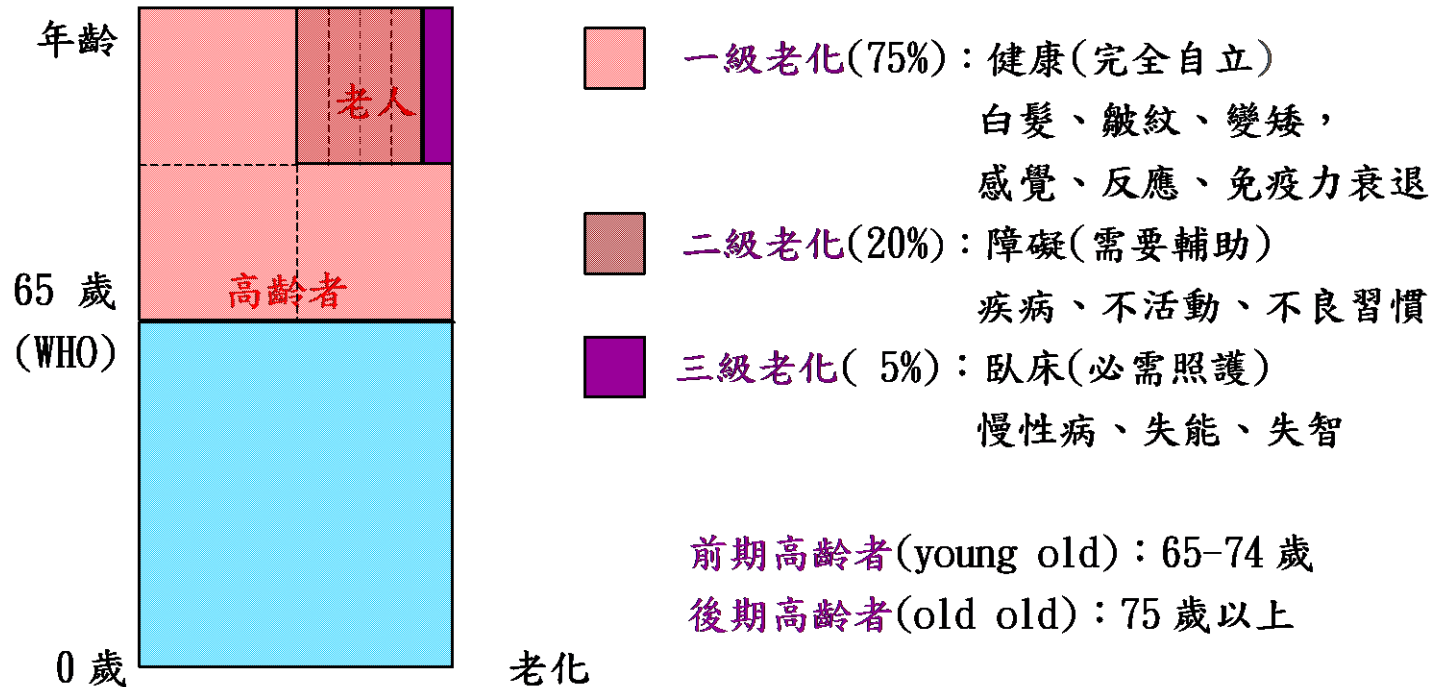

老人與老化

資料整理：陳政雄，2003年

1-2. 少子女化現象

台灣地區出生數推計 行政院經建會2006

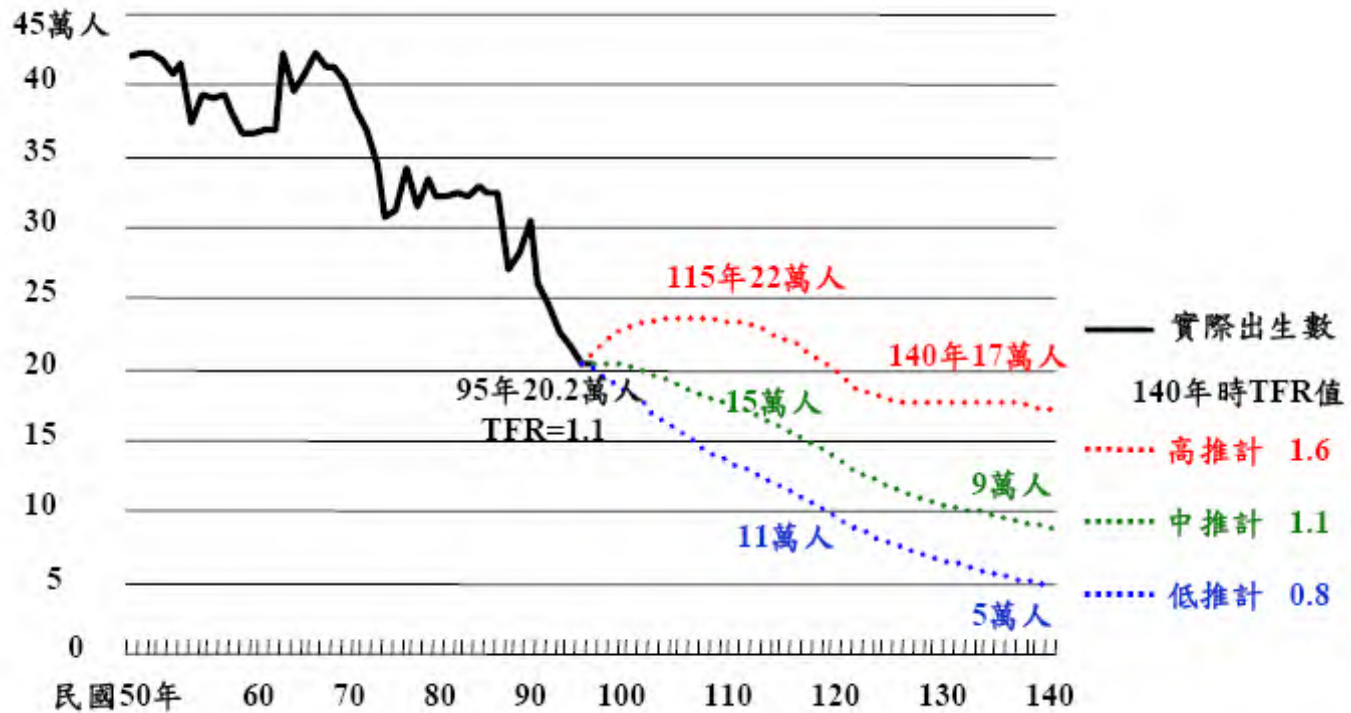

高齡住宅通用化原則

1. **無障礙**設計(barrier free)：
去除設施設備障礙，提供安全使用的設計。
2. **可適性**設計(adaptive design)：
因應身心狀況變化，提供適合使用的設計。
3. **終身的**設計(lifespan design)：
考慮生命週期多樣化，提供終身使用的設計。
4. **永續性**設計(sustainable design)：
考慮下世代、節能減碳，提供環境共生的設計。

無障礙住宅標章要求重點

- **主要出入口**淨寬不得 $<90\text{CM}$ 。內側淨空間不得 $<\phi 120\text{CM}$ 。
- **特定房間**(供行動不便者使用之臥室)出入口淨寬不得 $<90\text{CM}$ 。外側淨空間不得 $<\phi 120\text{CM}$ 。門扇應採外開式推門或橫向拉門。
- **特定房間之浴廁**出入口淨寬不得 $<80\text{CM}$ 。外側淨空間不得 $<\phi 120\text{CM}$ 。門扇應採用橫向拉門，門扇得設於牆之內、外側。
- **廚房**出入口淨寬不得 $<80\text{CM}$ 。外側淨空間不得 $<\phi 120\text{CM}$ 。廚房之地面應堅硬、平整、防滑。工作檯面之高度應距地板面高 $75\sim 80\text{CM}$ 。工作檯下方應留設至少 65CM 高容納膝蓋(含腳板)空間。
- **室內通路**淨寬不得 $<90\text{公分CM}$ 。連接日常生活空間之通道應為無高差，且地面防滑。室內至陽臺及露臺等出入口應順平。
- **浴廁**止水宜採用截水溝。浴廁之地面應堅硬、平整、防滑。浴缸底部應設置止滑片。洗面盆下方應留設至少 65CM 高可容納膝蓋之空間。
- 所有**電器插座及開關**之設置高度應距地板面高 $70\sim 100\text{CM}$ ，設置位置應易於操作且距柱、牆角 30CM 以上。

在宅老化的需求

WELFARE TECHNO-HOUSE
ウェルフェアテクノハウス神戸







▲ 玄関ホール
 延床面積: 136.50㎡ (建物面積: 114.45㎡ / 2階床面積: 97.16㎡)
 棟 高: 約3階建(約22m)
 所在地: 兵庫県神戸市西宮区西宮1-10-1

▲ 洋室
 ▲ 洋室(2) 移動用車
 ▲ 洋室(1) 移動用車

建設者: 有限会社 ウェルフェアテクノハウス
 〒650-0001 兵庫県神戸市西宮区西宮1-10-1
 TEL: 078-268-1111 FAX: 078-268-1000

販売: 株式会社 西宮テクノセンター
 〒650-0001 兵庫県西宮区西宮1-10-1
 TEL: 078-268-1111 FAX: 078-268-1000

設計: 株式会社 西宮テクノセンター
 〒650-0001 兵庫県西宮区西宮1-10-1
 TEL: 078-268-1111 FAX: 078-268-1000

ベッドからの起き上がり・立ち上がりを助ける 自立補助用具 P.22, 30, 43~45

介助バーは、組み合わせて使用することが可能です。



■アウツ用介助バー
つまみつけて体を支えます。使いやす
い両面に使用することができます。



■スイングアーム介助バー
つまみつけて体を支えます。使いやす
い両面に使用することができます。



■ミニ介助バー
つまみつけて体を支えます。スイングアームは
一定範囲の角度、おのり立ち上げ補助機
と、おのり補助機は一定範囲の角度、おのり
補助機を使用します。



■アシストバー
つまみつけて体を支えます。両面、両
面に使用することができます。立ち上げ補助機
と併用して使用します。

移動を助ける 移動補助用具 P.23, 30, 48~51



■杖(多脚タイプ)
自力での歩行に不安のある
方を補助します。



■歩行補助器
自力での歩行が困難な方の
体を支え、補助します。



■車いす
歩行が困難な方、または不
動歩行の方の移動補助用具です。



■電動介置リフト
歩行が困難な方、または不
動歩行の方の移動補助用具です。ベッド
の床いすなどへの移動も補助できま
す。自力での歩行が困難な
方、または不
動歩行の方の移動補助用具です。

充実した療養生活をすごすための テーブル P.23, 30, 52



■オーバーテーブル
ベッドワイドレールの上に
設置して使えます。



■サイドテーブル
キャスター付きで、テーブル
の移動が可能です。使用する方
に合った高さ調節が可能です。



■オーバーベッドテーブル
キャスター付きで、高さ調節
が可能です。



■背付テーブル
姿勢保持に不安があっても、ベッド
の中敷いすに固定した状態で
使用できます。安楽な姿勢で、
移動も行けるので、移動も行ける
ので使えます。

排泄を助ける P.30, 53 排泄補助用具



■自動排便器
ベッド上での排便が可能です。



■ベッドパン(差し込み便器)
ベッド上での排便が可能です。



■アクラベッド固定式トイレ
TEL: 027-407-1000
027-407-1000
027-407-1000
ベッドトイレの設置が
容易で、手すりをつまみながら
移動することが可能です。トイレは
ベッドに固定してあります。

ベッドまわりのより快適にする P.30, 54~55 いす・収納家具



■椅子上がり用
座面が厚く、高さ調節
できるので、立ち上がり
に不安な方でも無理なく
立ち上がりやすくなります。



■折りたたみいす
折りたたみ式で、使用し
ない時に邪魔になりま
せん。



■折りたたみいす
折りたたみ式で、使用し
ない時に邪魔になりま
せん。



■折りたたみいす
折りたたみ式で、使用し
ない時に邪魔になりま
せん。



■折りたたみいす
折りたたみ式で、使用し
ない時に邪魔になりま
せん。



■折りたたみいす
折りたたみ式で、使用し
ない時に邪魔になりま
せん。

この冊子は、高齢者が安心して暮らすためのヒントをまとめたものです。

老人住宅之分類

- 1986年，國際慈善機構（HTA）制定老年人居住建築的分類標準：
 - A類**：非老年專用或用作富有活力的退休和退休前老人居住的住宅。有生活自理能力，可獨立生活的寓所。如：(個人住所)
 - B類**：提供富有活力，基本生活自理，僅需要某種程度監護和少許幫助的健康老人居住的住宅。如：(個人住所)
 - C類**：專為健康富有活力的老人建造的住所，幫助老人基本獨立生活的設施，提供全天監護和最低限度的服務和公用設施。如：(長青公寓、退休社區)
 - D類**：專為體力衰弱但智力健全的老人所建造的住所。入住者不需要醫院護理，但可能偶然需要個人生活的幫助和照料、監護和膳食供應。如：(安養之家、仁愛之家、榮民之家)
 - E類**：專為體力尚健而智力衰退的老年人所建的住所。可能需要某些個人生活的監護和照料。公用設施同d類，但可按需另增護理人員。如：(失智老人之家、榮民之家、安養中心)
 - F類**：專為體力和智力都已經衰退，並需要個人監護的老人所設。入住者很多人生活不能自理，因而住所不可能是獨立的，提供入住者進餐、助浴、清潔和穿衣等服務。此類建築物如：(個人照顧之家、療養機構、養護之家)
 - G類**：入住者除同f類外，還有患病、受傷的，臨時或永久的病人，這類建築中所提供醫療和護理的應是註冊醫護機構，住房幾乎全部應為單床間。如：(療養機構、養護之家)

老人住宅浴廁規範

- 浴室及廁所其寬度及深度均不得小於1.8公尺，但廁所及洗手臺使用部分與沐浴使用之部份以固定隔間或防水拉門分隔，能確保廁所及洗手臺地坪維持乾燥者，廁所及洗手臺使用部分之長度及寬度淨尺寸分別不小於1.6公尺及1.5公尺，其配置應使老人方便到達及考慮老人與輪椅使用者之容易使用。居住單元未設浴廁者，與其最近之浴廁距離不得大於10公尺。浴廁出入口高低差應為2公分以下，門扇應採外開式推門或橫拉門，並可由外面拆卸以利緊急救援，浴廁及臥室應設置呼救系統，並得考慮設計防震、防火構造，以作為就地避難場所。

老人住宅盥洗設備規範

- 設置人員異常自動感應警報設備，門以拉門或摺疊衣室為佳，洗面應設置感應式把手及簡易臺應使用撥桿式龍頭或可考慮在37公分至43公分之間，宜考量有洗淨臭氣抽送考慮設有通脫臭機能、臀部乾燥設施，馬桶應設緊急救上下、左右可動式扶手，以便利如廁。65公分至70公分之間。個人特殊考量時為應留設直徑150公分之迴轉空間，並儘可能保持馬桶周圍有足夠讓照顧者使用之輔助空間，或預留輕微改造後可以確保其空間。

老人福利機構走道等設施法令規定架構

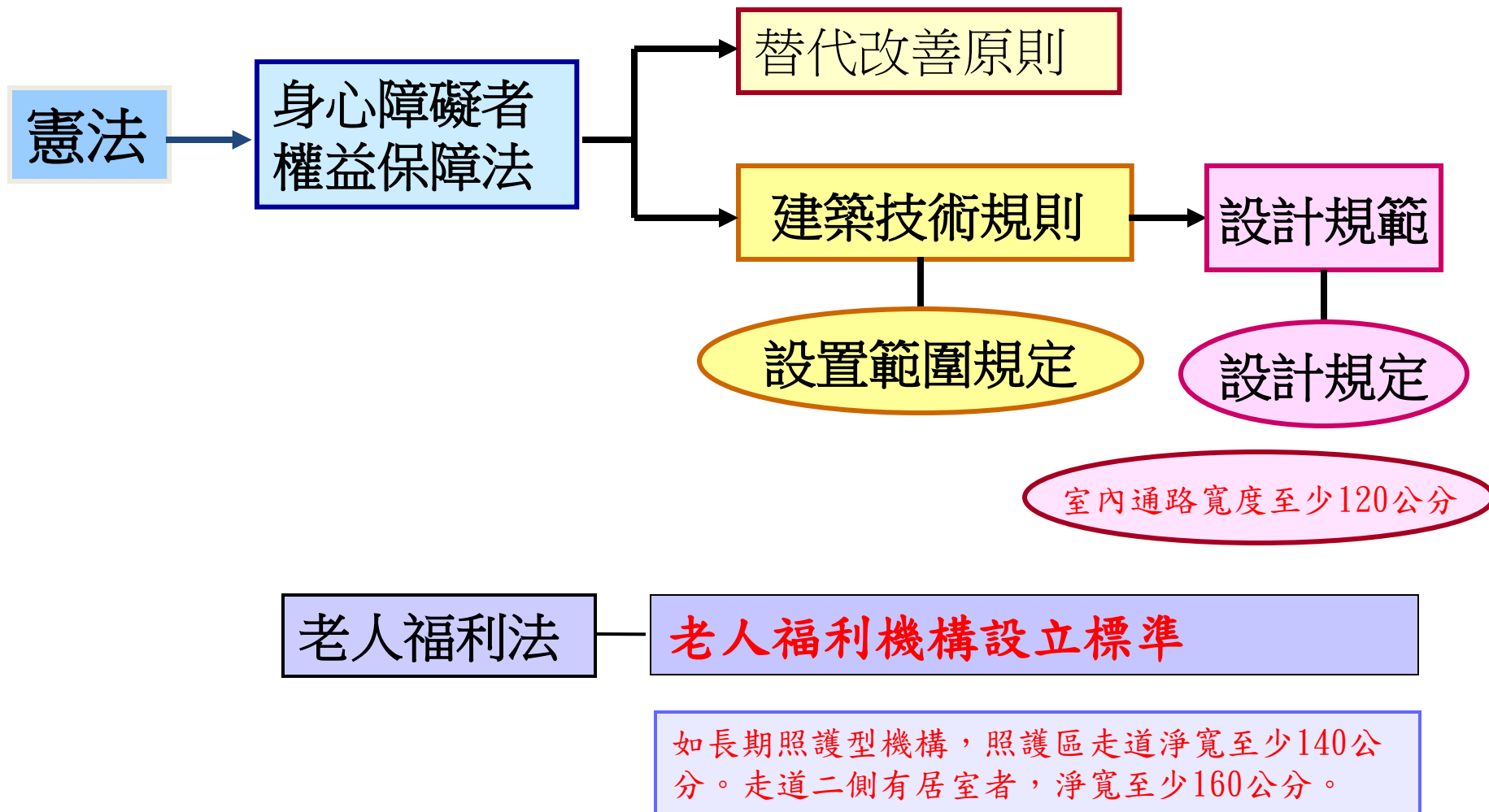

老人福利機構

本法所定老人福利機構，依其照顧對象，分類如下：

一、長期照顧機構：分為下列三種類型：

- (一) 長期照護型：照顧罹患長期慢性病，且需要醫護服務及他人照顧之老人。
- (二) 養護型：照顧生活自理能力缺損需他人照顧之老人或需鼻胃管、胃造廔口、導尿管護理服務需求之老人。
- (三) 失智照顧型：照顧神經科、精神科或其他專科醫師診斷為失智症中度以上、具行動能力，且需受照顧之老人。

二、安養機構：照顧需他人照顧或無扶養義務親屬或扶養義務親屬無扶養能力，且日常生活能自理之老人。

三、其他老人福利機構：照顧需其他福利服務之老人。

機構類型	長期照護型	養護型	失智型	安養型
社工人員 (人)	1 : 100	公立、財團法人：1 : 100 免辦財團法人：專任或特約	1 : 100	公立、財團法人：1 : 80 免辦財團法人：專任或特約
護理人員 (人)	1 : 15	1 : 20	1 : 20	至少1人
照顧服務員 (人)	日間：1 : 5 夜間：1 : 15	日間：1 : 8 夜間：1 : 25	日間：1 : 3 夜間：1 : 15	日間：1 : 15 夜間：1 : 35
每位老人樓地板面積 (平方公尺)	公立、財團法人：16.5 免辦財團法人：16.5	公立、財團法人：16.5 免辦財團法人：10	公立、財團法人：16.5 免辦財團法人：16.5	公立、財團法人：20 免辦財團法人：10
每位老人寢室面積 (平方公尺)	公立、財團法人：7 免辦財團法人：7	公立、財團法人：7 免辦財團法人：5	公立、財團法人：7 免辦財團法人：7	公立、財團法人：7 免辦財團法人：5
每一寢室床位數、衛生設備	每一寢室至多設六床。 公立、財團法人50床以上者：每一寢室應設簡易衛生設備。	每一寢室至多設六床。 公立、財團法人50床以上者：每一寢室應設簡易衛生設備。 免辦財團法人：每照顧16人應設男廁一間及女廁二間。	每一寢室以服務一人為原則。 每一寢室應設簡易衛生設備。	每一寢室至多設三床。
日常活動空間 (平方公尺)	公立、財團法人：4 免辦財團法人：4	公立、財團法人：4 免辦財團法人：	公立、財團法人：7 免辦財團法人：	公立、財團法人：6 免辦財團法人：
主任、院長	專任	專任	專任	專任
收容人數 (人)	公立、財團法人：50人以上~200人以下 免辦財團法人：5人以上未滿50人			公立、財團法人：50人以上~200人以下 免辦財團法人：5人以上未滿50人

慢性醫院、護理之家與老人福利機構人員標準比較表

類別	護理之家	長期照護機構	養護機構	安養機構
醫師	視業務需要得置專任或特約醫師	視業務需要得置專任或特約醫師	視業務需要得置專任或特約醫師	視業務需要得置專任或特約醫師
護理人員	1 每十五床至少應有一人。 2 二十四小時均應有護理人員值班。 3 設有日間照護者，按登記提供服務量，每登記提供二十人之服務量，應增置一人	隨時保持至少有一位護理人員值班。每照護十五位老人應置一人。若設有日間照護者，每提供二十人之服務量，應增置一人。	大型：隨時保持至少有一位護理人員值班。每養護二十位老人應置一人。 小型：得以專任或特約方式辦理，隨時保持至少有一位護理人員值班。	大型：隨時保持至少有一位護理人員值班。 小型：得以專任或特約方式辦理，隨時保持至少有一位護理人員值班。
藥師	視業務需要得以專任或特約方式辦理	視業務需要得以專任或特約方式辦理	視業務需要得以專任或特約方式辦理	視業務需要得以專任或特約方式辦理
物理治療人員	視業務需要得以專任或特約方式辦理	視業務需要得以專任或特約方式辦理	視業務需要得以專任或特約方式辦理	視業務需要得以專任或特約方式辦理
職能治療人員	視業務需要得以專任或特約方式辦理。	視業務需要得以專任或特約方式辦理。	視業務需要得以專任或特約方式辦理。	視業務需要得以專任或特約方式辦理
服務人員	每五床應有一人以上。	每照護五位老人應置一人。	大型：每養護八位老人應置一人。 小型：每養護八位老人應置一人。機構內隨時保持至少有一位服務人員值班。	大型：每安養十五位老人應置一人。 小型：每安養十五位老人應置一人。機構內隨時保持至少有一位服務人員值班。
社會工作人員	1 未滿一百床者，應指定專人負責社會服務工作。 2 一百床至二〇〇以下者，應有一人。 3 二〇〇床以上者，至少應有二人。	1 未滿一百人者，應指定專人負責社會服務工作。 2 一百人以上未滿二百人者，應置一人。 3 二百人以上者，至少應置二人。	大型：至少應置一人，每養護百位老人應增置一位。 小型：視業務需要得以專任或特約方式辦理。	大型：至少應置一人，每安養八十位老人應增置一位。 小型：視業務需要得以專任或特約方式辦理。
其他	1. 應有指定人員管理護理紀錄。 2. 視業務需要得置專任或特約營養師。	視業務需要得置專任或特約營養師。	大型：視業務需要得置行政人員、專任或特約營養師或其他工作人員。 小型：視業務需要得置專任或特約社會工作人員及其他必要人員。	大型：視業務需要得置行政人員、專任或特約營養師或其他工作人員。 小型：視業務需要得置專任或特約社會工作人員及其他必要人員。

評鑑1- 整體環境及設施第4項：無障礙樓梯

每幢建築物應至少設置一座無障礙樓梯。

標準：

1. 符合「**建築物無障礙設施設計規範**」設置規定。
2. 梯級：級高18公分以下、級深25公分以上。
3. 扶手：兩側設置高75-85公分之扶手，扶手端部並作防勾撞處理。
4. 樓梯底版高度：樓梯底版至其直下方地板面淨高未達190公分部份設置防護設施。
5. 防滑條：梯級邊緣之水平踏面部份作防滑處理。

評鑑3 - 整體環境及設施第6項：無障礙升降機

機構內每幢2層樓以上建築物應：

1. 至少設置1座無障礙升降機，且該升降機符合「建築物無障礙設施設計規範」設置規定。
2. 至少設置1座無障礙升降機，且該升降機門寬80公分以上、梯廂深度135公分以上並至少一側設置扶手。
3. 未設置升降機，但屬專供安養老人使用之建築物，其無障礙通路應可到達一般院民使用之公共空間（如餐廳及集會廳等），且
 - (1) 無障礙通路（或其替代改善設施）可到達之房間數超過總房間數50%以上者。
 - (2) 無障礙通路（或其替代改善設施）可到達之房間數超過總房間數30%以上者。

評鑑4 - 整體環境及設施第8項：無障礙廁所

每幢建築物應至少設置1處無障礙廁所。

標準：

1. 符合「建築物無障礙設施設計規範」設置規定。
2. **無障礙通路**：至少有1條無障礙通路（無高差、有高差處設坡道、寬度90公分以上）可到達，且廁所門淨寬80公分以上。
3. **馬桶形式**：使用標準座式馬桶。
4. **扶手**：應設置至少一側扶手。
5. **迴轉空間**：廁所內具有直徑150公分之迴轉空間。
6. **求助鈴**：至少設置兩處求助鈴。
7. 多人使用之廁所，應有適當之隔間或門簾。

評鑑5 - 整體環境及設施第7項：無障礙浴室

每幢建築物應至少設置1處無障礙浴室。

標準：

1. 符合「**建築物無障礙設施設計規範**」設置規定。
2. **無障礙通路**：至少有1條無障礙通路（無高差、有高差處設坡道、寬度90公分以上）可到達，且浴室門淨寬80公分以上。
3. **地面**：使用防滑材料或作防滑處理。
4. **扶手**：設置扶手協助變換姿勢及防止滑倒。
5. **求助鈴**：至少設置兩處求助鈴。
6. **隔間**：多人使用之浴室設置隔間或隔簾。
7. **溫度**：浴室具維持適當溫度之設備。
8. **沐浴設備**：具適合臥床或輪椅乘坐者使用之沐浴設備。

長照機構類型

善誠長照	特 色	開放時間	長輩接受度	花費總金額	適合的使用者
<p>住宿式 機構</p>	<p>全天候照護，醫療資源相對豐富，能提供完整照護。</p>	<p>24小時</p>	<p>接受度<低> 大部分長輩不願全天待在照護中心。</p>	<p>較高 部分可申請『政府補助』</p>	<p>慢性病嚴重、插管治療，或需長時間照護的長輩。</p>
<p>社區式 機構</p>	<p>無須入住，提供日間托顧的服務及接送服務。</p>	<p>日間時段（平日）</p>	<p>接受度<中> 大約一兩週後開始習慣。</p>	<p>較低 大多可申請『長照2.0補助』</p>	<p>失智、失能，或想走出家門與人建立社交連結的長輩。</p>
<p>居家 服務中心</p>	<p>居服員親自到長輩家中，提供個別化的照顧服務。</p>	<p>日間時段（平日） 少數提供晚間時段</p>	<p>接受度<高> 部分長輩會排斥家屬外的人照護。</p>	<p>較高 部分可申請『政府補助』</p>	<p>行動不便、較注重隱私，或習慣在家中環境的長輩。</p>

機構護理人員值班

類別	護理之家	老人長期照顧中心 (長期照顧型)	老人長期照顧中心 (養護型)	安養機構 
服務對象與內容	<ul style="list-style-type: none"> 慢性病患者等需長期護理的患者。 出院後需要護理的患者。 目前臺灣的護理之家主要有兩種型態： <ol style="list-style-type: none"> 醫院附設的護理之家。 獨立型態的護理之家。 	<ul style="list-style-type: none"> 有慢性病且有長期醫療服務需求的長者。 與護理之家不同之處是設立之負責人非護理人員。 	<ul style="list-style-type: none"> 無法自主生活，但不需要專門看護服務的長者。 收容有意識但需要協助生活行為的長者。 *現在也有養護中心會提供場所讓長者做復健活動及休閒康樂。 	<ul style="list-style-type: none"> 欲自費入住的長者。 有長照必要的獨居長者。 無重大疾病，生活可自理的長者。 提供基本保健服務、運動休閒空間，及醫護通報系統的環境，但無法行使醫療行為。
基本人員	<ul style="list-style-type: none"> 每 15 床至少應有 1 位護理人員。 24 小時均應有護 	<ul style="list-style-type: none"> 每 15 床至少應有 1 位護理人員。 24 小時均應有護 	<ul style="list-style-type: none"> 隨時保持至少 1 位護理人員值班。 每 20 位長者應 	<ul style="list-style-type: none"> 隨時保持至少 1 位護理人員值班。

輪椅族的特性與實際操作

1. 輪椅重心高, 容易失去平衡
2. 移動緩慢, 視野高度80-120cm。
3. 使用輔具: 支架, 助走器, 拐杖, 輪椅
4. 需要他人協助
5. 開啟困難: 手指肢障礙者

銀髮族之環境障礙

- 一. 地表裝修材質濕滑。
- 二. 迴轉空間不足：例如出入口、廁所、電梯間…
- 三. 高低差：例如地坪、樓層…
- 四. 輔助設施缺乏或設計不當：例如樓梯扶手、安全扶手…
- 五. 操控器設置不當：例如開關按鈕、門把…

老人使用助行器 台北

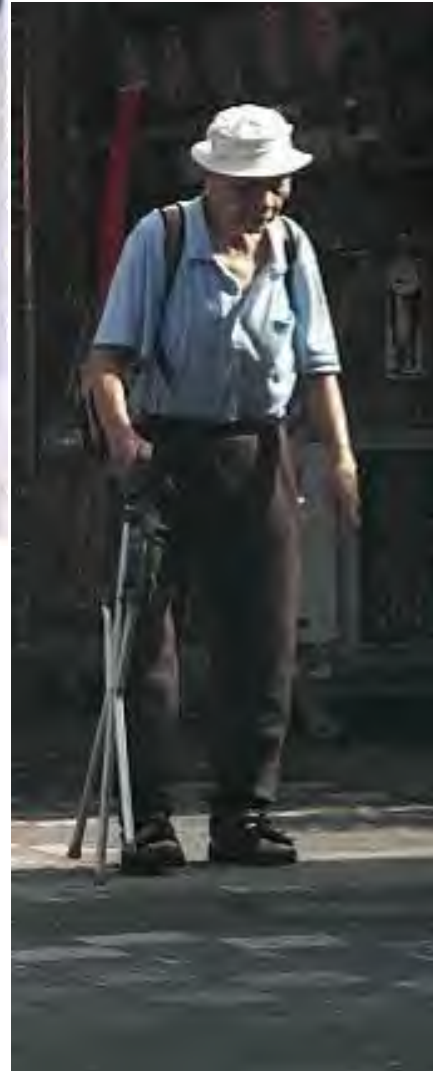





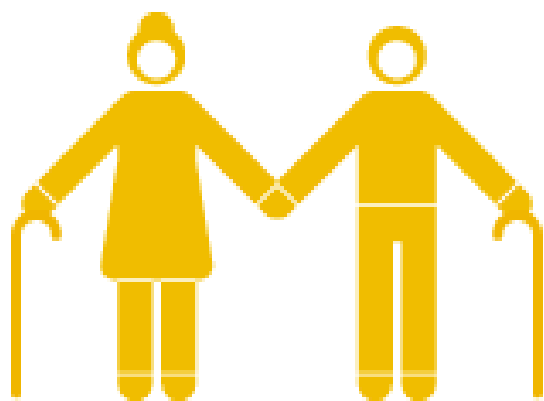
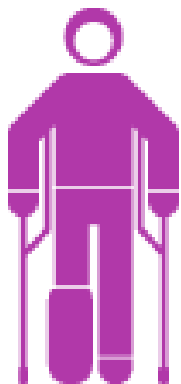



BURL DESERT FLOWER INDIGO

請關心行動不便者



輪椅 & 助行車規格表

Wheelchair & Rollator Specification

規格 型號									重量
	座寬	座深	總寬	總長	總高	扶手高	肩高	座高	
JW-001	44	43	68	102	87	23	40	47	16.5kg
JW-020	47	45	71	123	125	23-28	84	50	18.8kg
JW-020 16"	41	45	65	123	125	23-28	84	50	15.6kg
JW-100	44	43	68	102	87	23	40	47	13.6kg
JW-150	44	43	68	102	88	23	40	47	13.7kg
JW-120	44	43	68	100	87	22	40	47	13.6kg
JW-125	44	43	68	100	88	22	40	47	13.7kg
JW-160	46	43	65	102	89	22	40	47	14.3kg
JW-160 16"	40	43	59	102	89	22	40	47	14.0kg
JW-230	45	41	60	79	89	24	43	47	9.5kg
JW-230-20	45	41	62	93	89	24	43	47	10.5kg
JW-250	43	40	59	94	84	22	39	45	11.8kg
JW-350	43	40	55	84	84	22	39	45	10.8kg
JW-450	45	40	63	99	88	22	39	47	12.3kg
JW-X30	41	40	62	84	89	22	44	45	9.5kg
JW-X30-20	41	40	64	96	89	22	44	45	10.kg
JW-330	44	40	63	96	83	23	39	43	11.5kg
JW-340	44	40	55	81	83	23	39	41	10.5kg
JW-510	45	43	60	89	88	22	41	47	11.1kg
JW-520	45	43	65	100	90	22	41	50	12.6kg
JK-005	45	34	62	64	80-90	N/A	N/A	49	7.5kg
JK-006	45	34	60	73	84-98	N/A	N/A	49	7.8kg

單位: cm +1cm +0.5kg

水平移動設施

輪椅正向往上；倒退而下

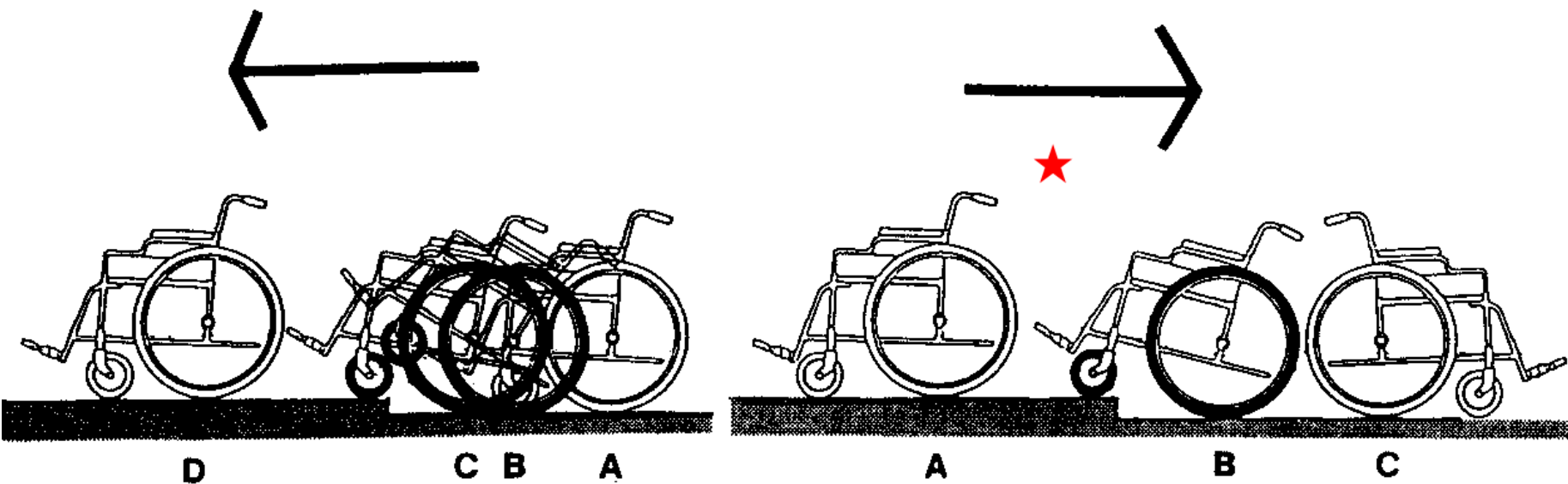

椅上人生

Las ruedas de la vida...

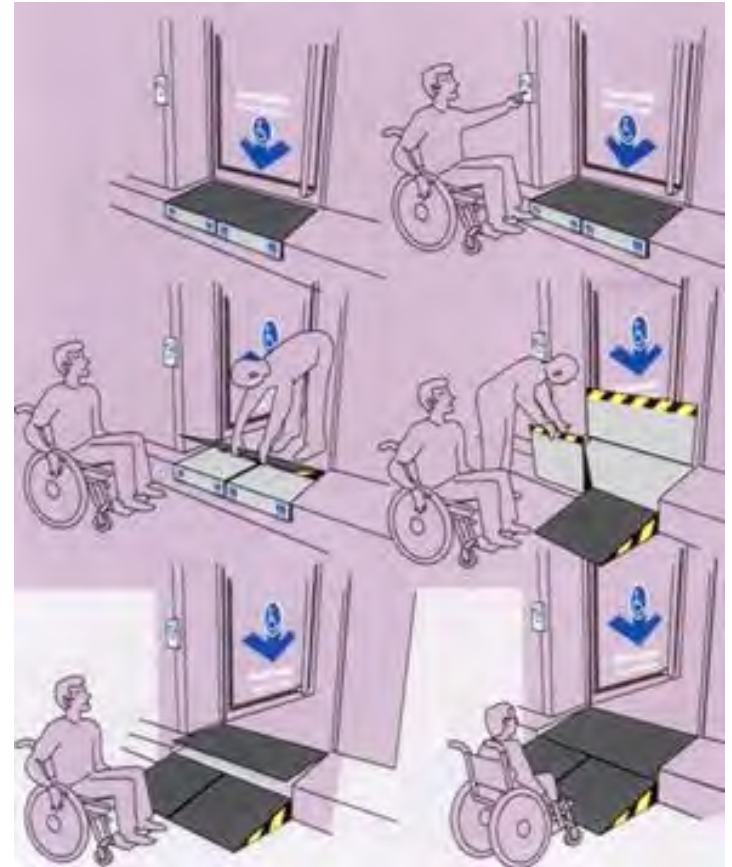
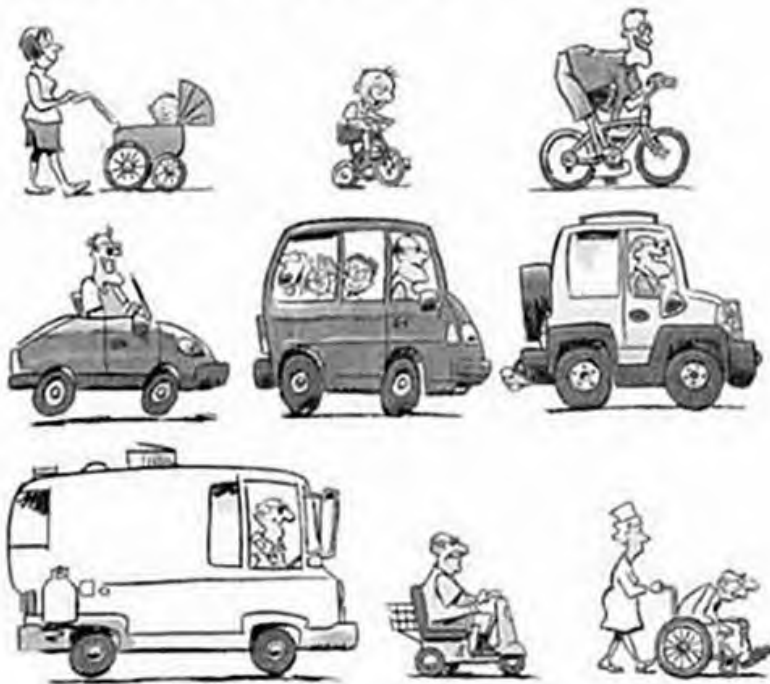

袖珍輪椅、代步車



科技進步的產品



直立功能輪椅



人可站立之輪椅



銀髮族的輪椅生活



老人外出



輪椅族外出



無障礙汽機車



寶風三輪代步車

型號 450Y
馬力 52V H 88A H B
重量 71kg
速度 40~60公里
電費 88公里/小時
結構 鋁合金



國外低地板公車



Free Bus in Auckland city



輪椅接送車輛



RUL300

RUL300 - Manual Model
Standard Model for cost-effective operations. The lift cassette is opened manually and the lift pulled out by the operator. The lift is then ready to operate from the two-button control.

Ratcliff Underfloor Pass with the operator and passenger models are 'user-friendly' to use' two button control for smooth and safe ride.

Underfloor lifts are now for many reasons - firstly no space is 'lost' to maximum seating capacity of the way' when not required for vehicle use.



RUL300A

RUL300A - Automatic Model
Designed for frequent use. Operated from a two-button control, the "up" button lowers the cassette cover, deploys the lift to a convenient height for unfolding the platform and raises lift in open position. The "down" button lowers the lift and, when the platform is folded, stows the lift ready for travel. There's no need for the operator to bend or lift.

RUL301A



RUL301A - Automatic Model with Extended Platform
Enjoys all the benefits of the RUL300A with the additional advantage of a full 1350mm deep platform.

Fits a wide range of factory built van conversions and coachbuilt bodies up to a floor height of 1100mm.

老人的休閒生活



丹麥女王夫婦



當年老時候

張玉芸照



賞花、聞花



種花



釣魚、遙控飛機



休閒育樂



輪椅者運動



公園步道國外

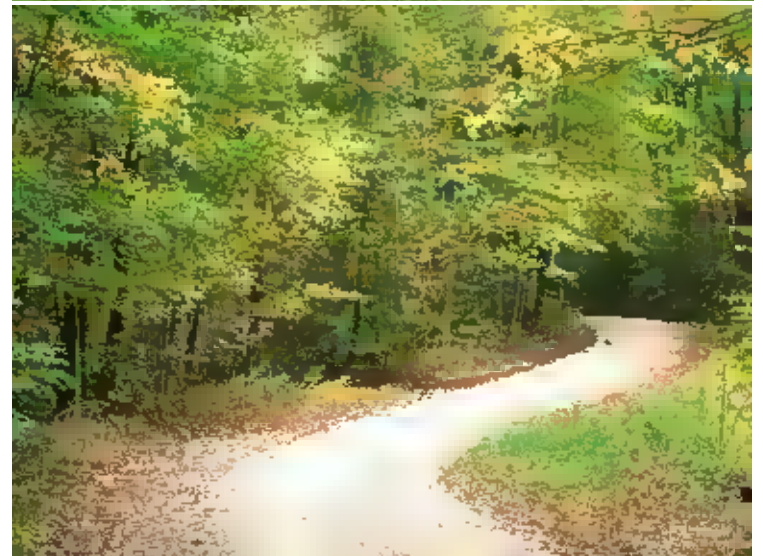
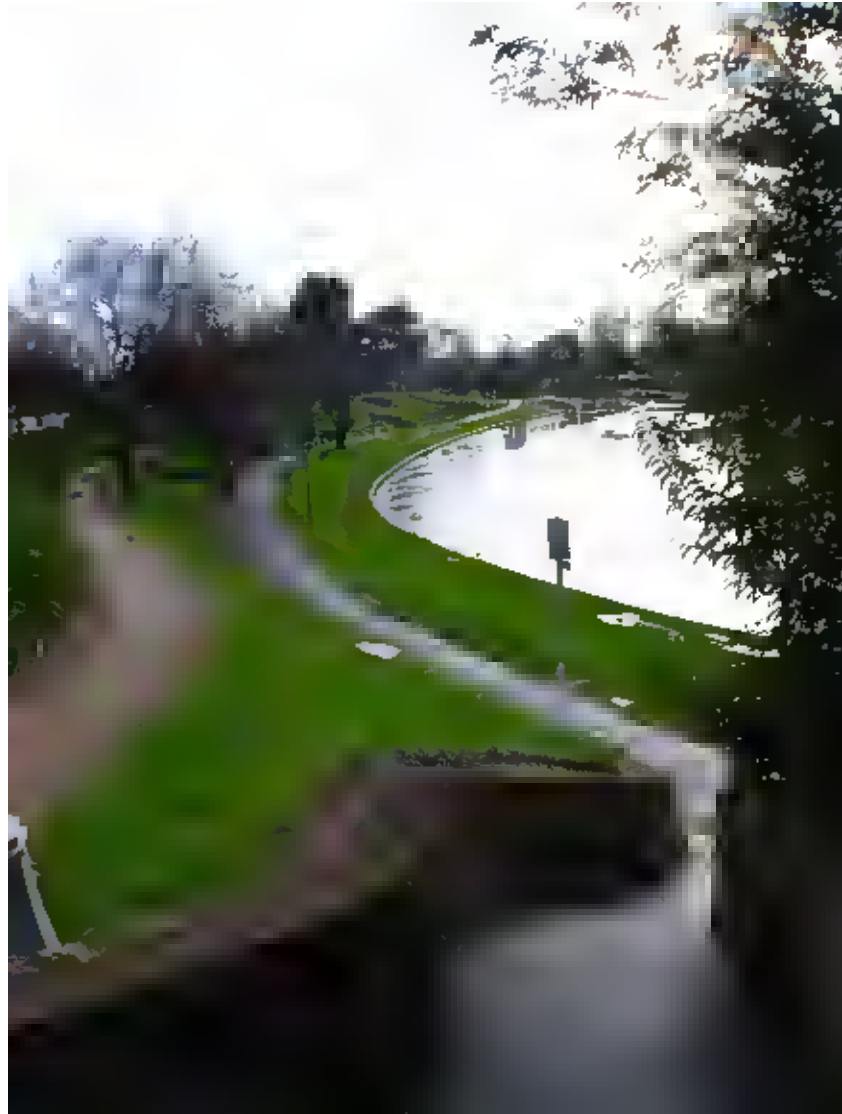

戶外空間



輪椅行進空間

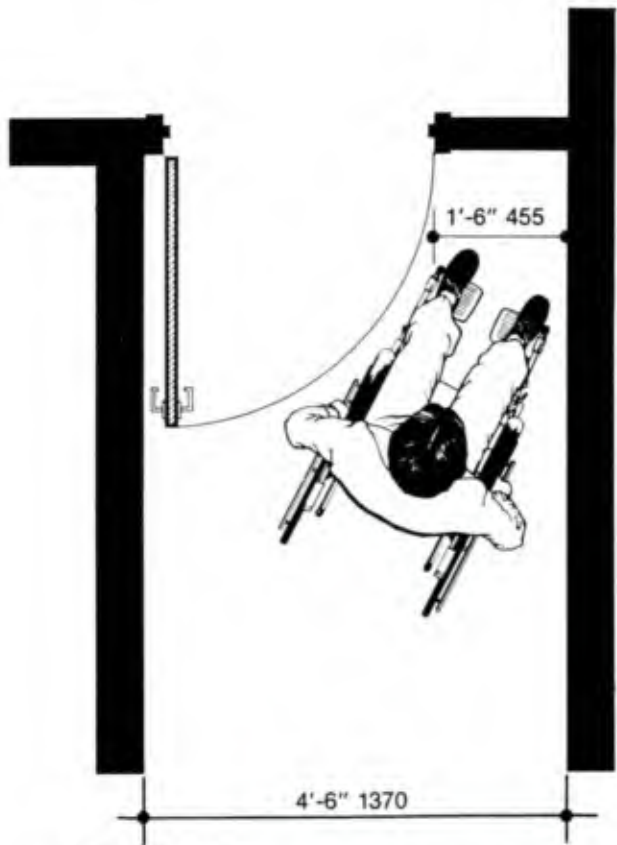

Figure 2.3.2 D
Minimum dimension of corridor width with door opening into the corridor.

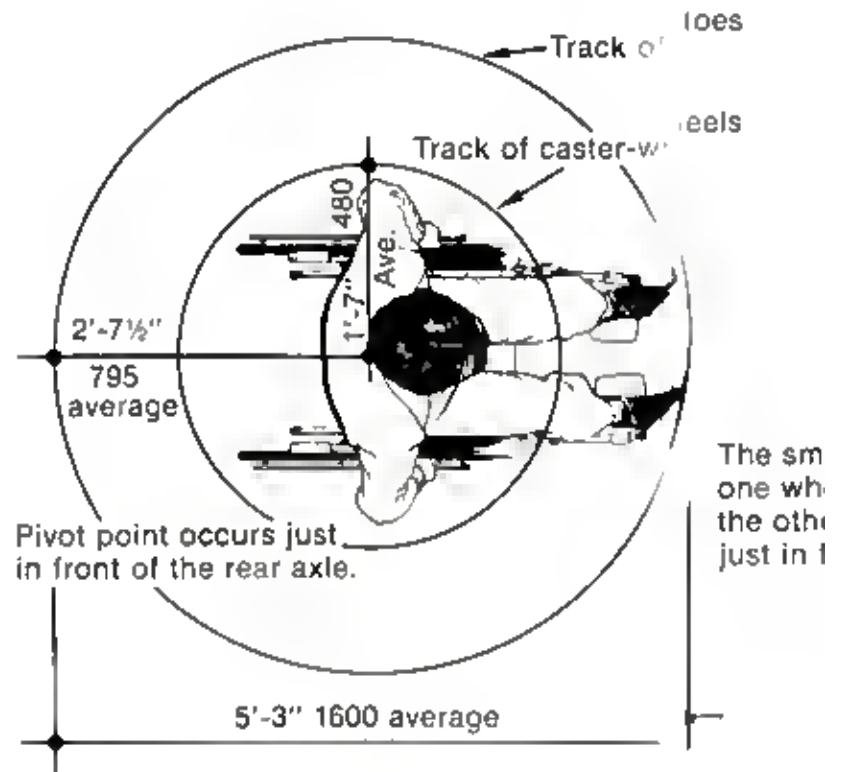

Figure 2.3.2 D-1
Turning radius of a wheelchair

輪椅行進空間



Figure 2.3.4 A
Minimum corridor width.
Does not allow passing.



Figure 2.3.4 B
Minimum corridor width which allows passing of a pedestrian and a person in a wheelchair.

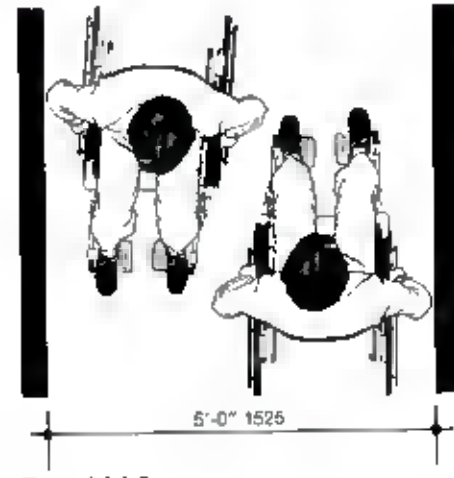

Figure 2.3.4 C
Minimum corridor width which allows two wheelchairs to pass

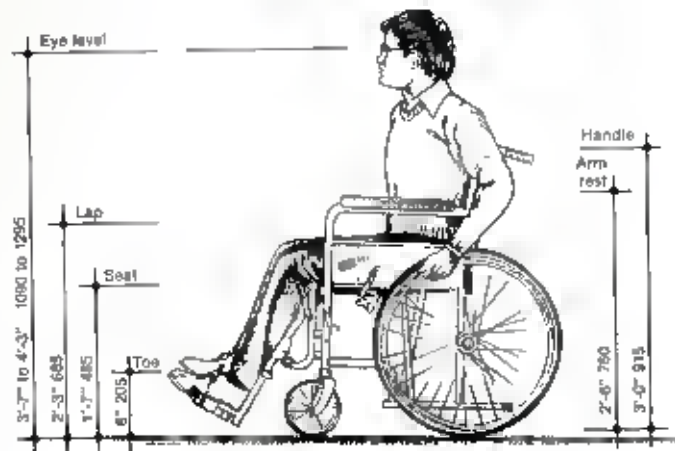

Figure 2.3.1
Dimensions of a manual, adult sized wheelchair

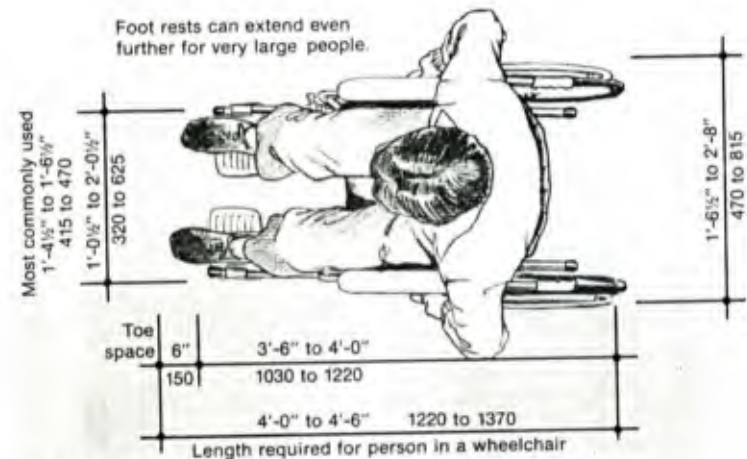
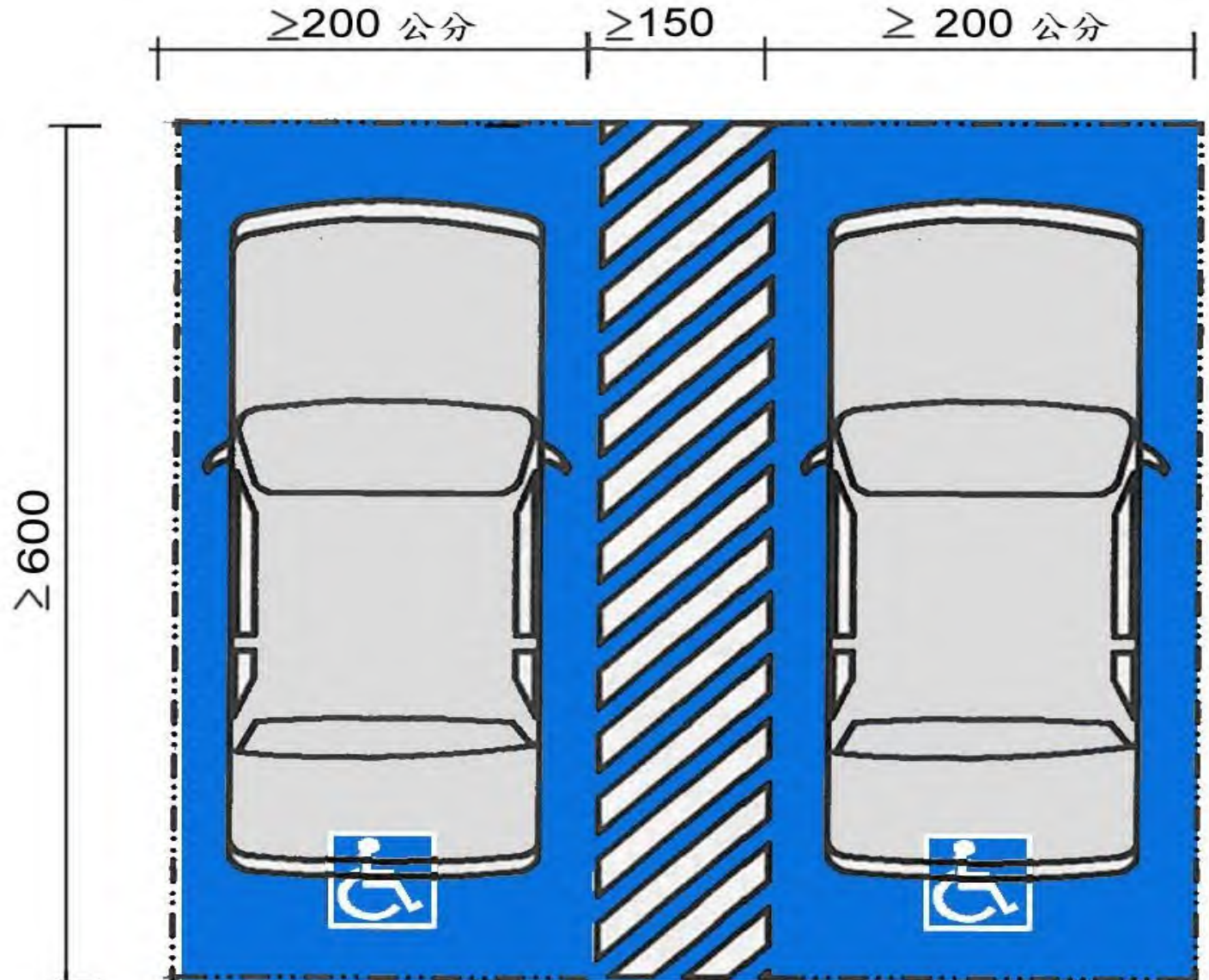

Figure 2.3.1

專用停車位

專用停車位需要一個寬一百五十公分的上下車區，地面最好漆成藍色與其他停車位有所區隔，並且要有一個白色輪椅標誌，



美國的緩坡道

陳淑珍 攝

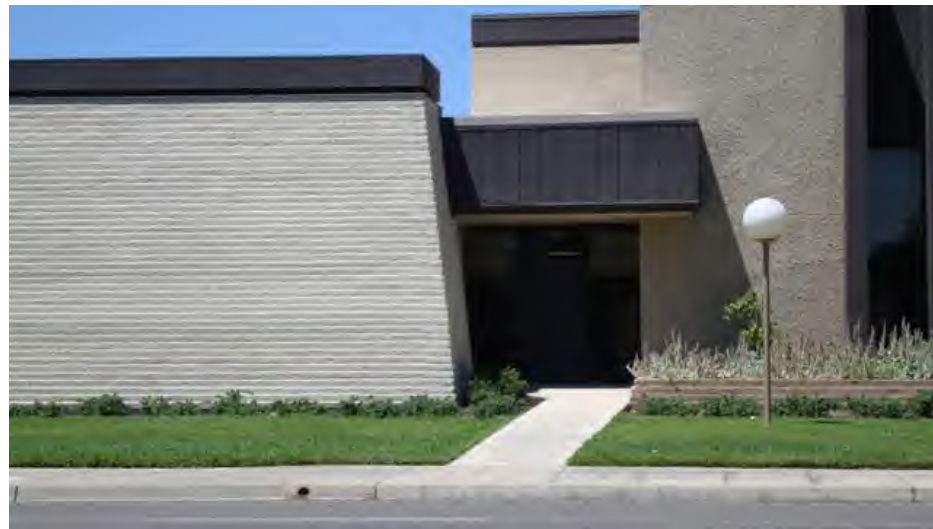

美國加州警示磚



□ 橫斷人行道的斜坡



色彩安全管理



色彩安全管理



色彩安全管理

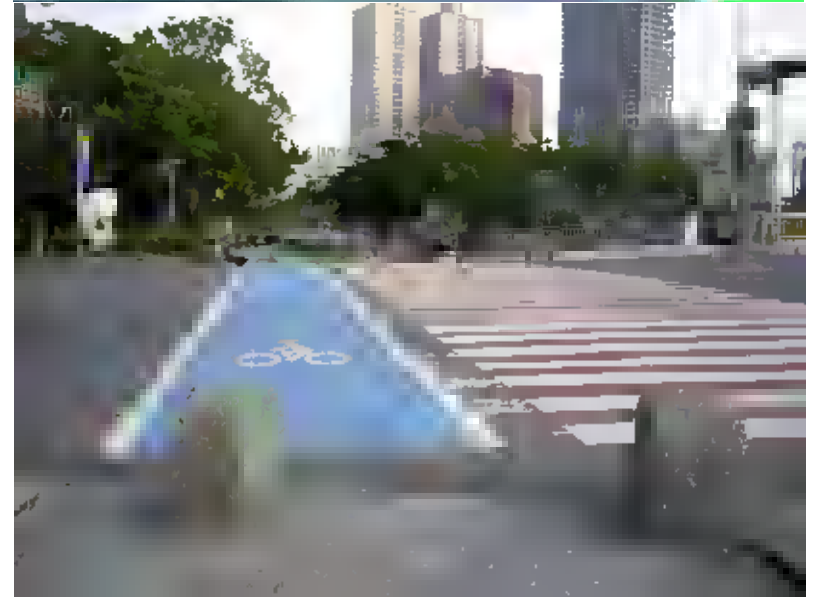

臨停、休息區

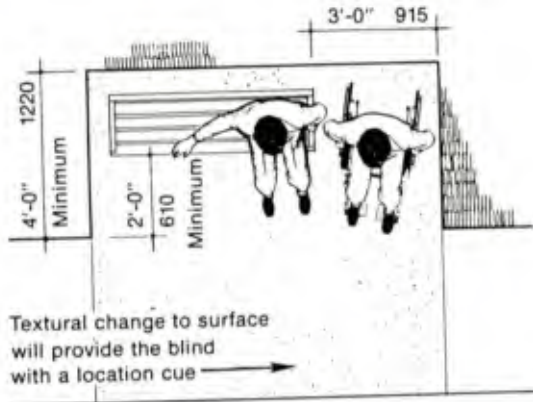

A.

Figure 3.7.4
Space requirements for wheelchairs adjacent seating

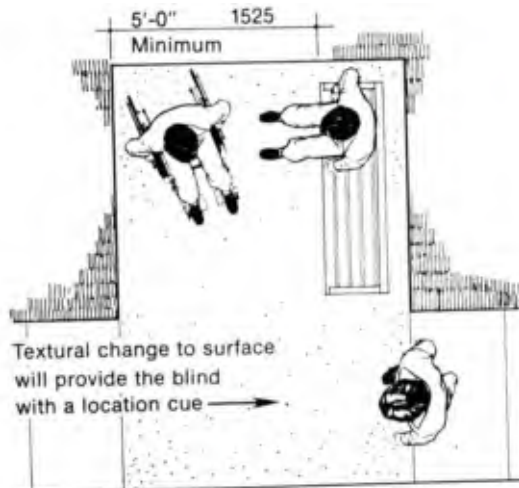

B.



地圖版的設置



山區步道防滑處理 止滑塑鋼網



注意有水即濕滑的鋼板



容易濕滑的鋼板



無法即刻辨識的危險



清晰的邊界線

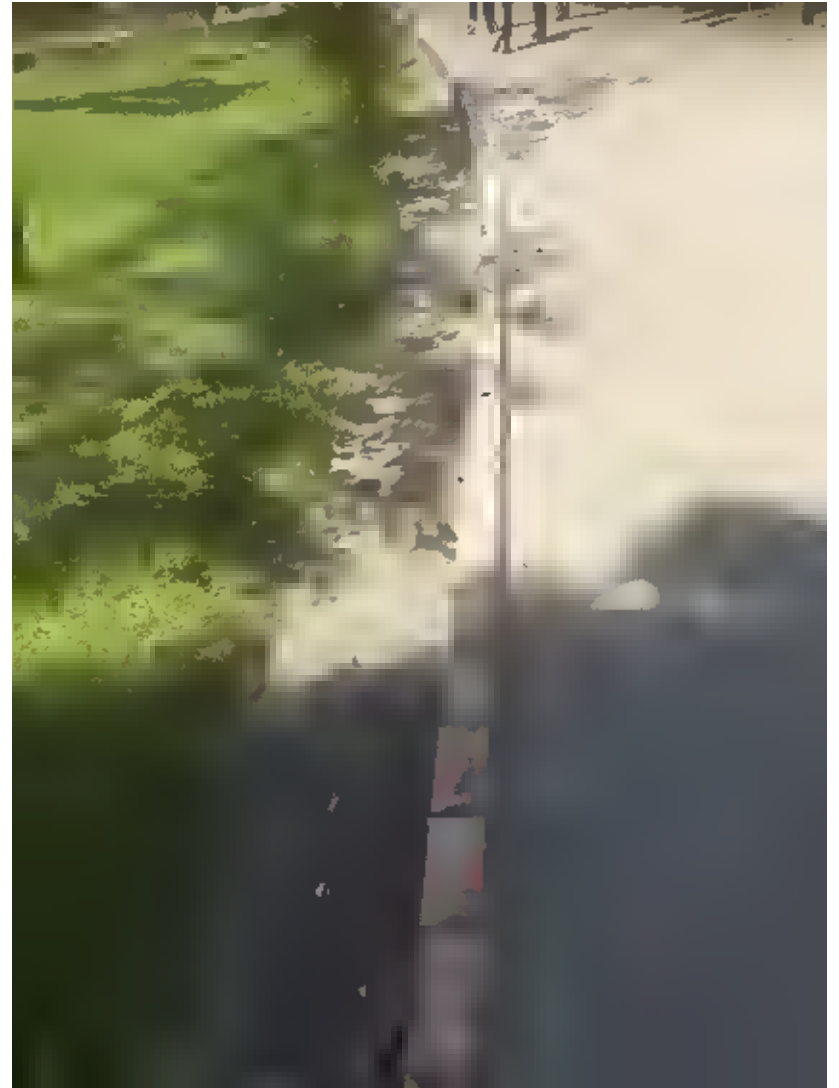

國家公園步道



輪椅會車及等候空間

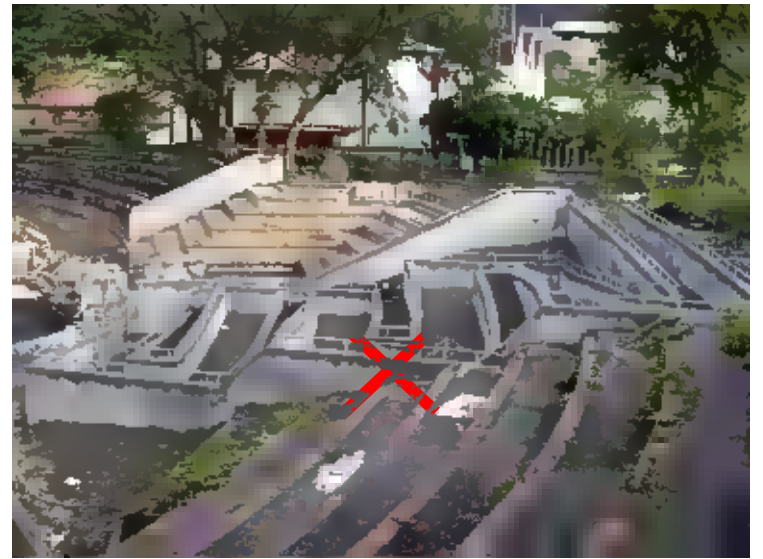

有需求自設斜坡



住宅大樓入口

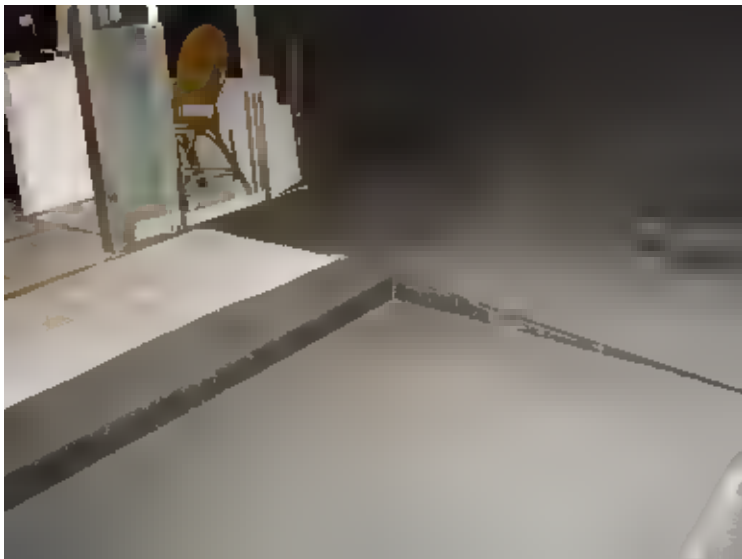
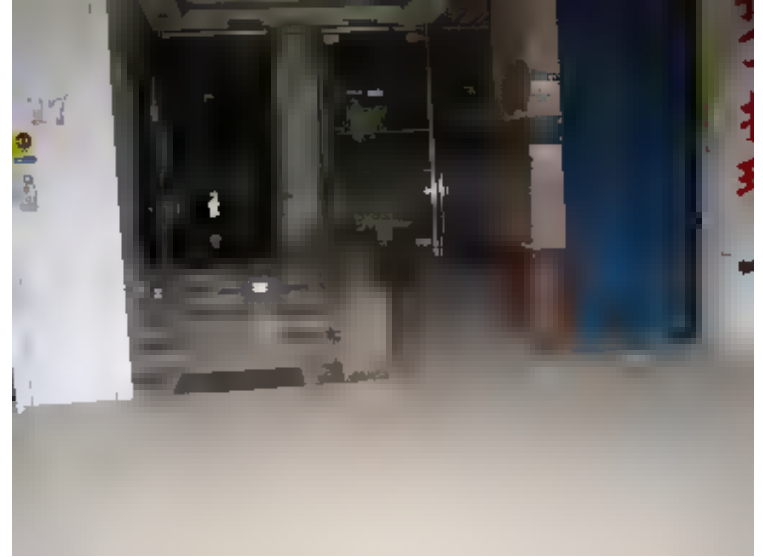

騎樓原有高低差整成斜坡



機車灣，形成通用騎樓，不怕日曬雨淋，想要打通騎樓，就要看縣市長的魄力。

兼供拄柺杖者行走加設防護緣



室外地面材料

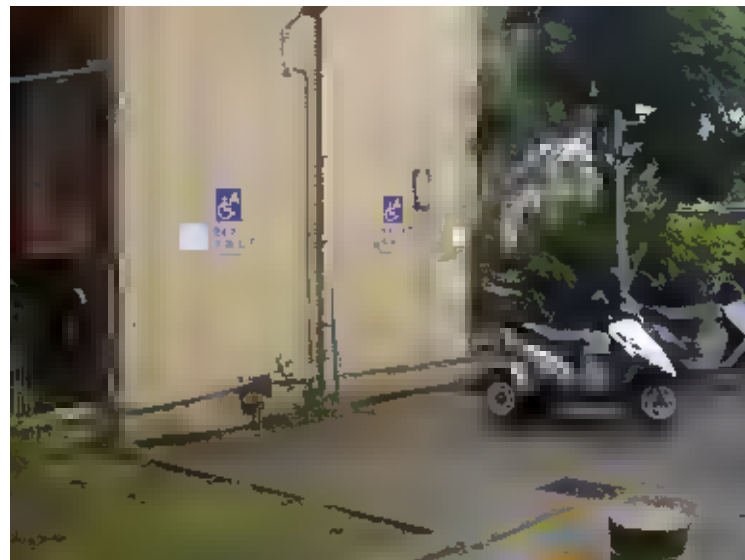

歐洲散步道地面材



老人住宅坡道規範

- 室外引導通路淨寬度應在1.2公尺以上，坡度不得大於1/12，坡道長度每9公尺或在轉折處應設置長度1.5公尺以上之平臺，坡度在1/20以下時，平臺間隔可放寬至18公尺，坡度大於1/20且高低差大於60公分者，應設置扶手。戶外地面設置之排水溝格柵方向應和行進方向垂直，格柵淨孔距不得大於1.3公分。

開門前的平台

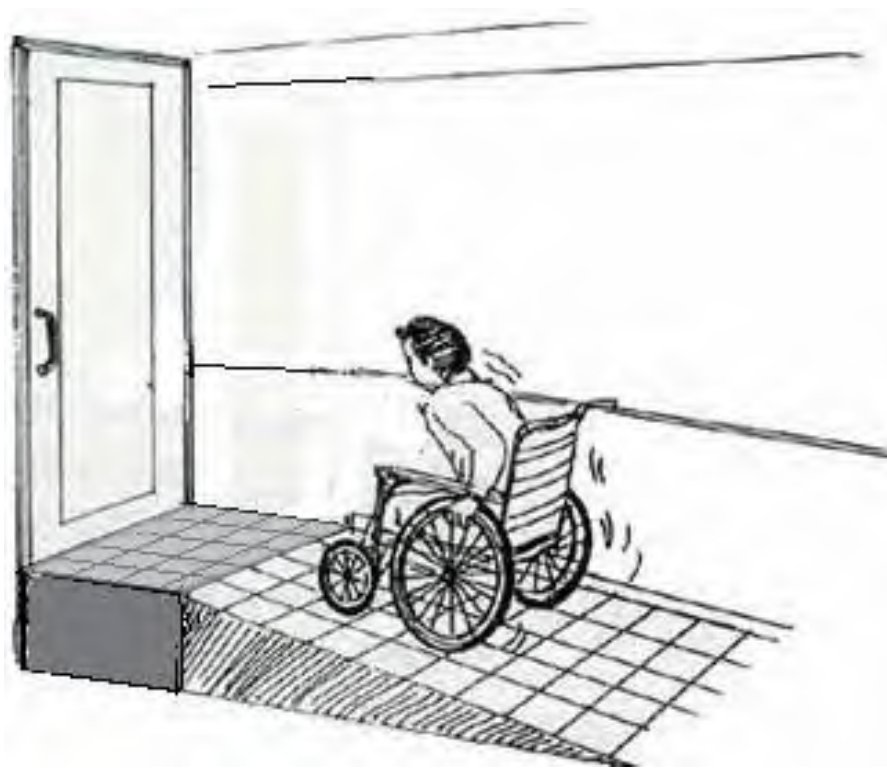

防護措施

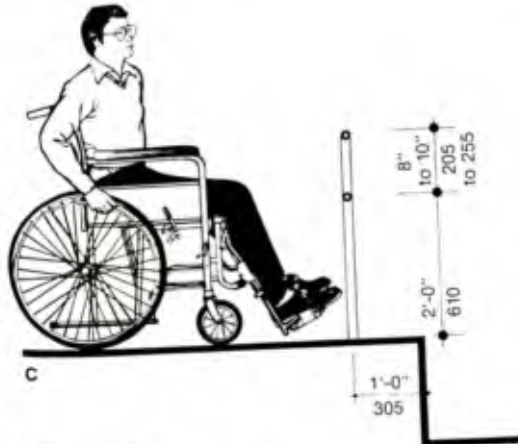

Figure 3.2.9 C, D
Examples of Barriers at edge of hazardous area

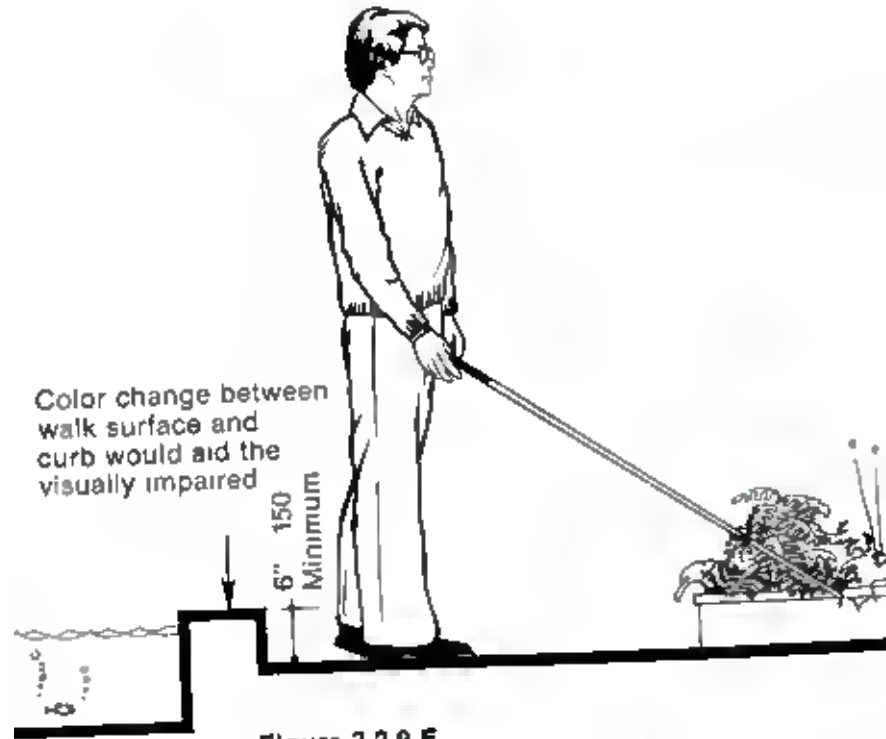
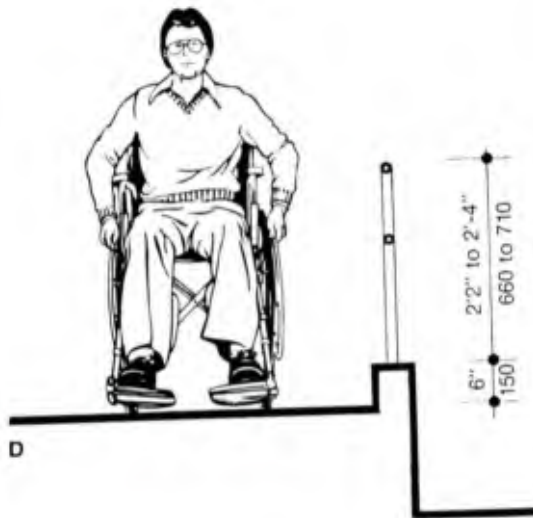
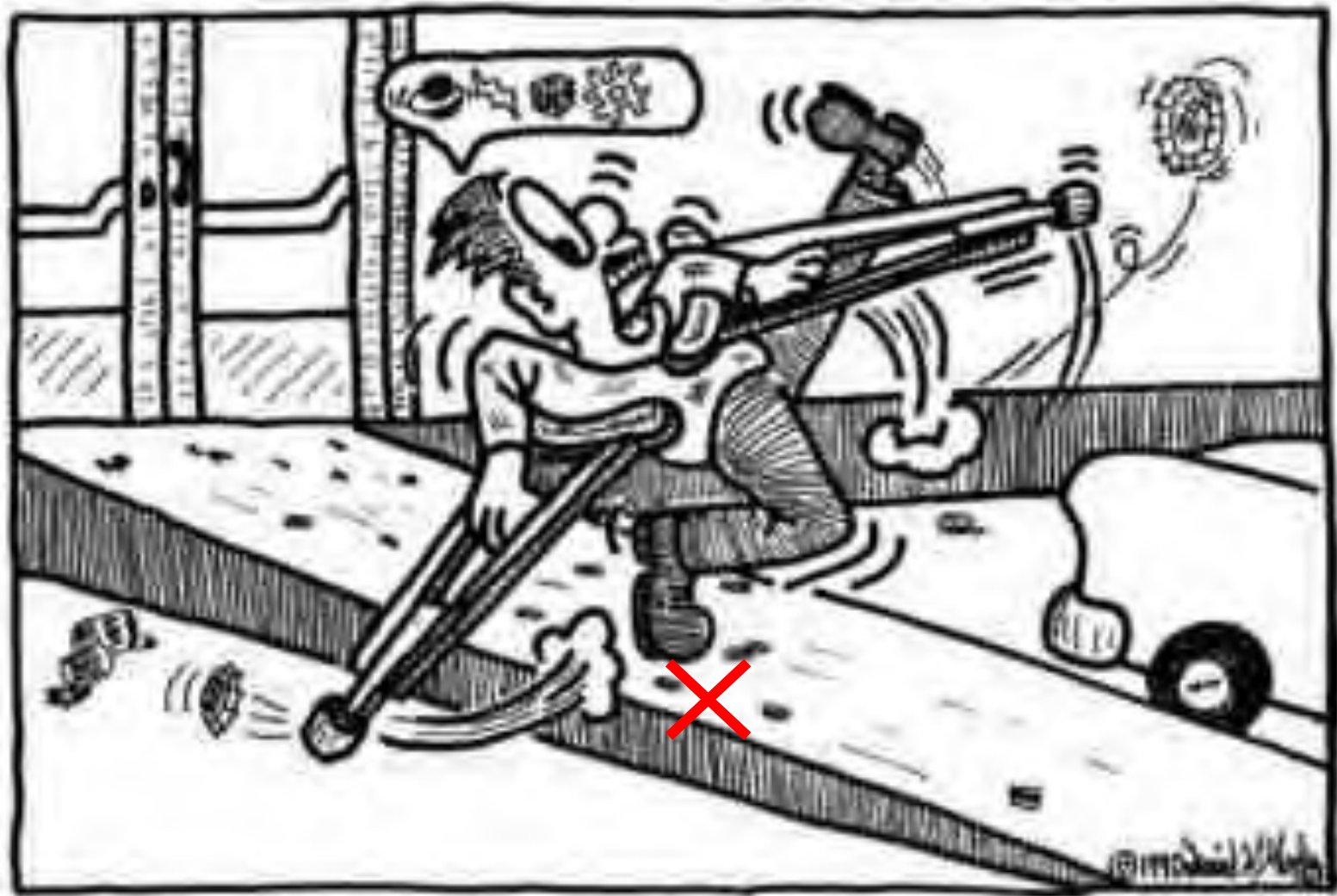

Figure 3.2.9 E
Locatable barriers around pools and landscaping

缺防護緣的結果



□ 免扶手坡道



高差**超過20cm**之坡道，兩側應設置符合規範之連續性扶手，且得免設置水平延伸。

教室門檻內削斜坡



高低差外補或內削比較

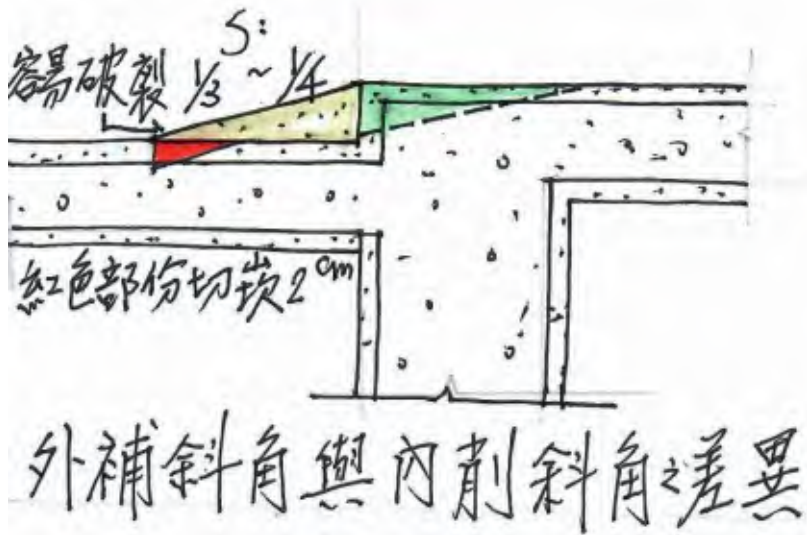

斜坡板

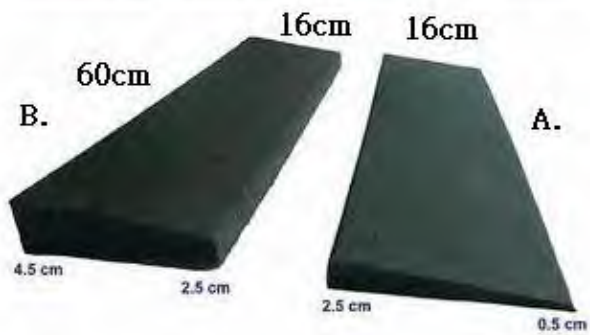
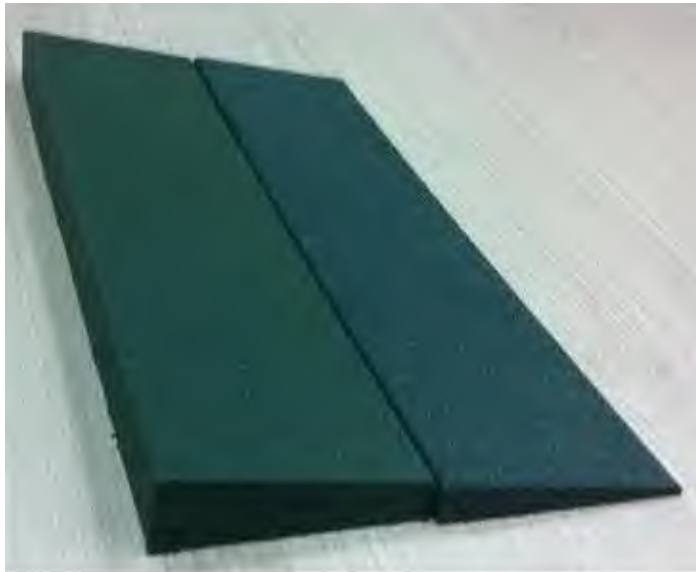

止滑斜坡板



提供輪椅乘坐者的方便



店鋪超商無障礙



木斜坡板

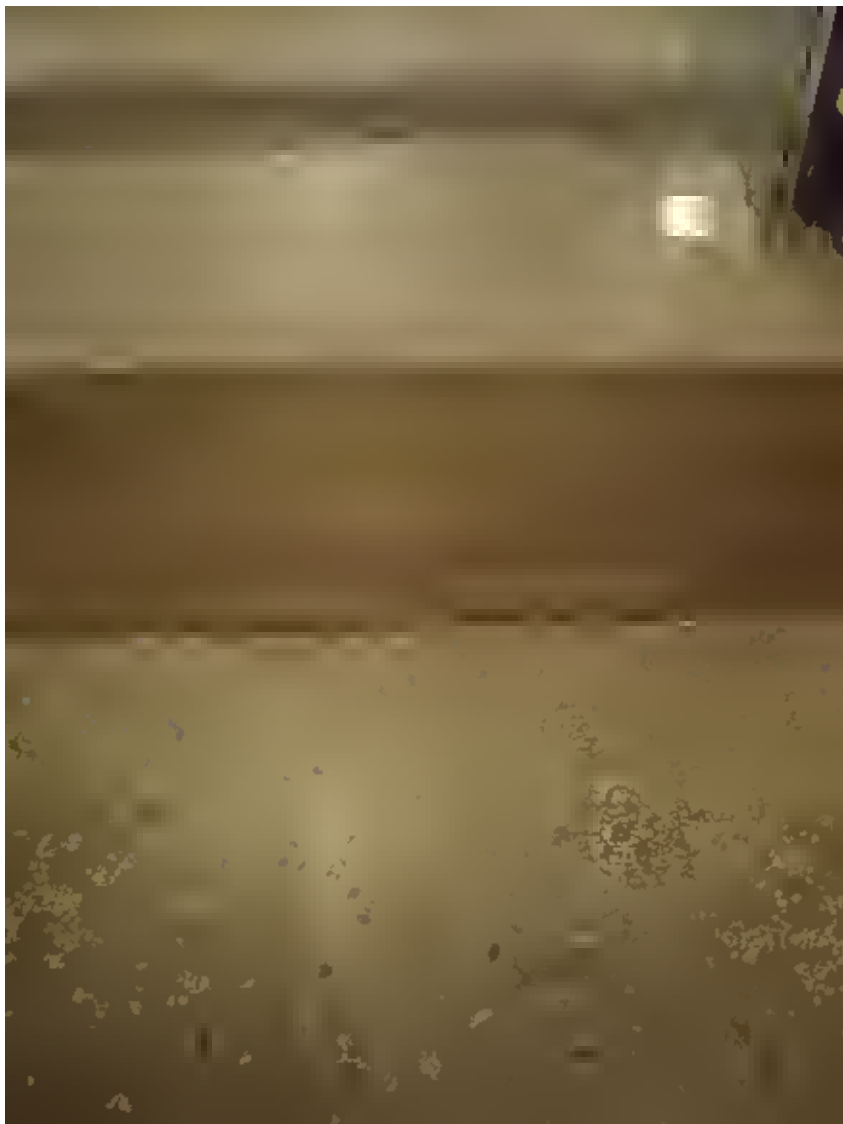

室內坡道

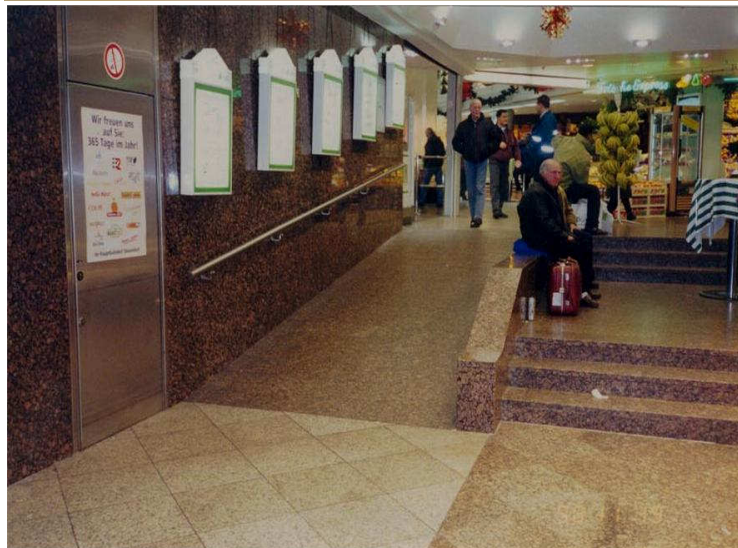

活動斜坡板



中間支撐型移動式斜坡板



活動斜坡板替代

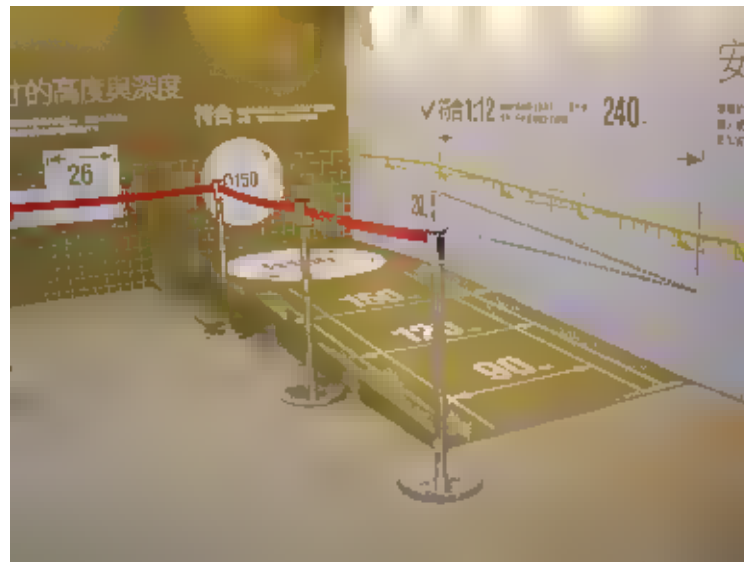

斜坡板



活動坡板



移動式大型斜坡板



老人住宅坡道規範

- 室外引導通路淨寬度應在1.2公尺以上，坡度不得大於1/12，坡道長度每9公尺或在轉折處應設置長度1.5公尺以上之平臺，坡度在1/20以下時，平臺間隔可放寬至18公尺，坡度大於1/20且高低差大於60公分者，應設置扶手。戶外地面設置之排水溝格柵方向應和行進方向垂直，格柵淨孔距不得大於1.3公分

坡道防護緣



坡道應有之尺寸



圖305.4.1.2



圖305.4.1.3

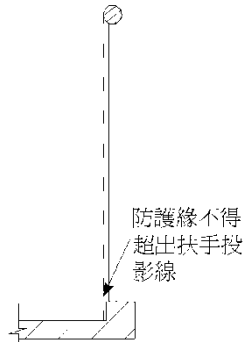

圖305.5.2

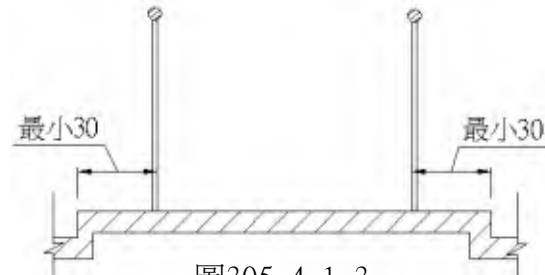

圖305.5.4

坡道扶手種類

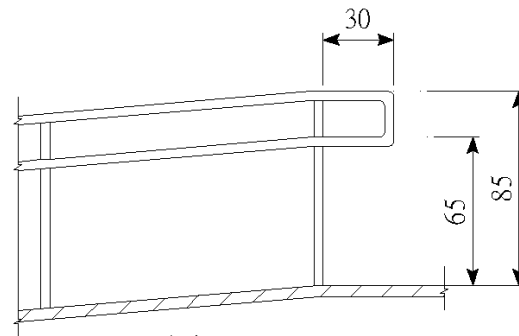
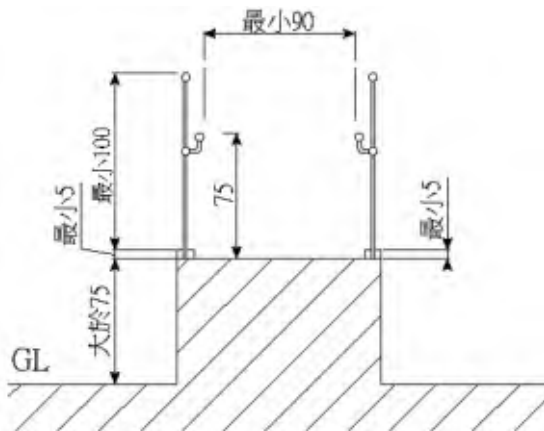

S304、S316、S408、木扶手



日本新型扶手



適合老人握持的扶手



高鐵細扶手種類

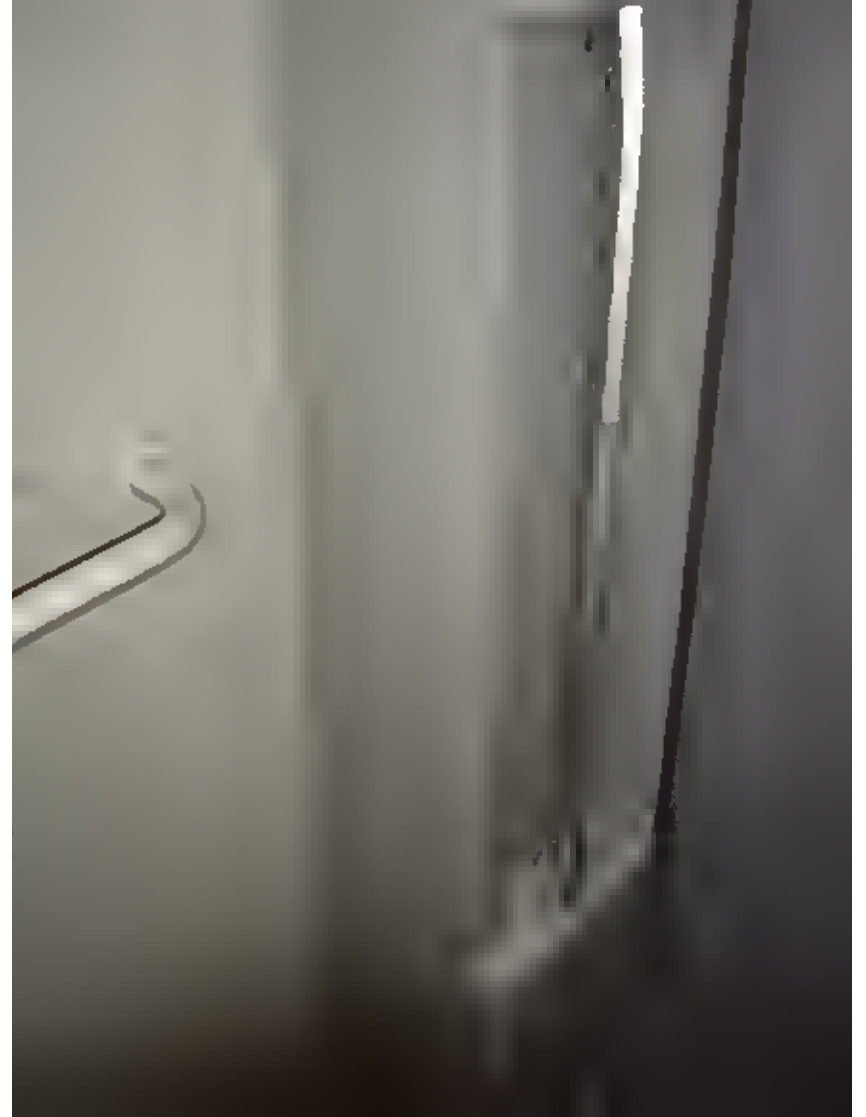

邊界線利用為室外引導通路



人行步道國內實例



路口無障礙處理



路口無障礙處理



洩水溝蓋

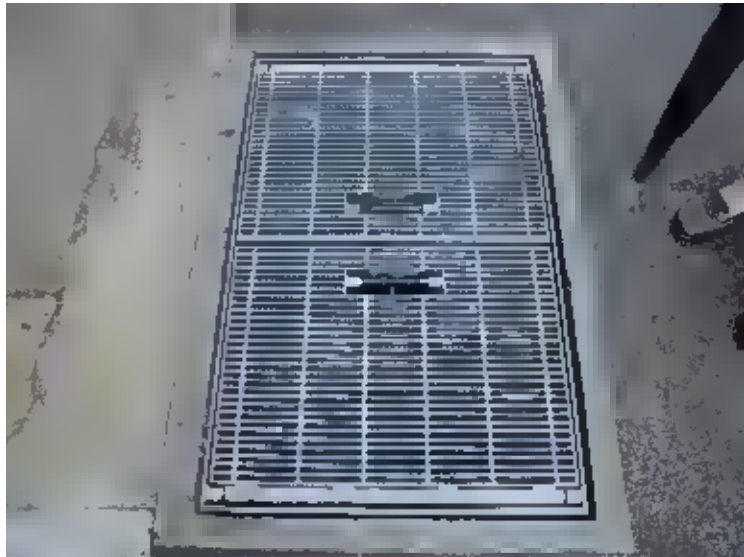
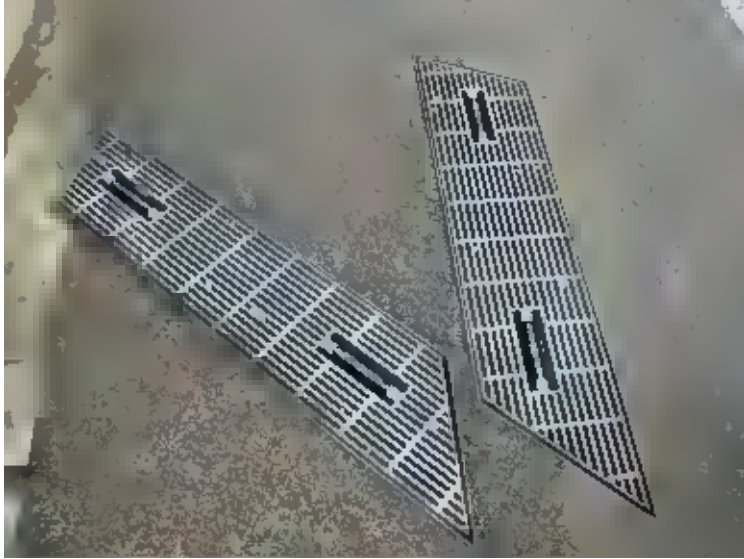

細孔柵溝蓋



溝蓋更新



耐壓透水格柵

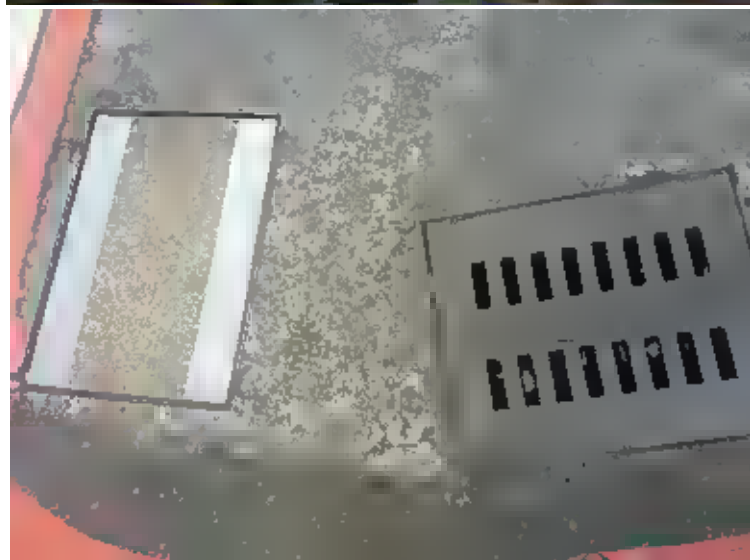
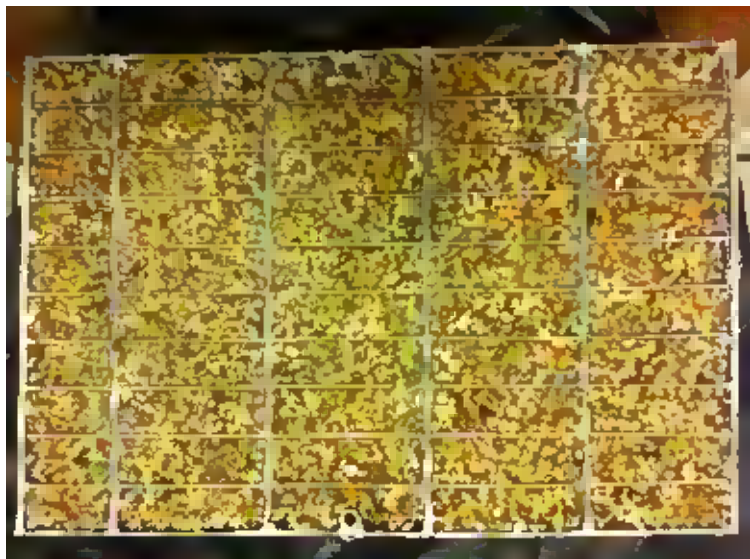

顏色區分辨識

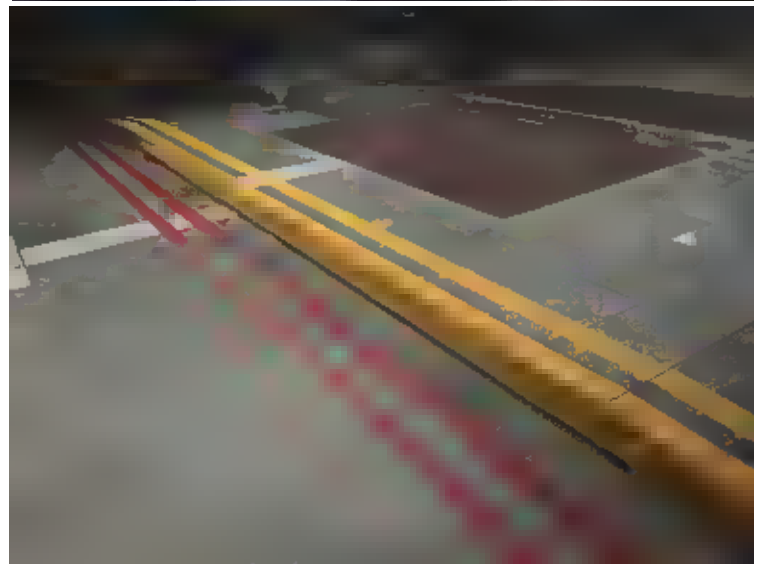
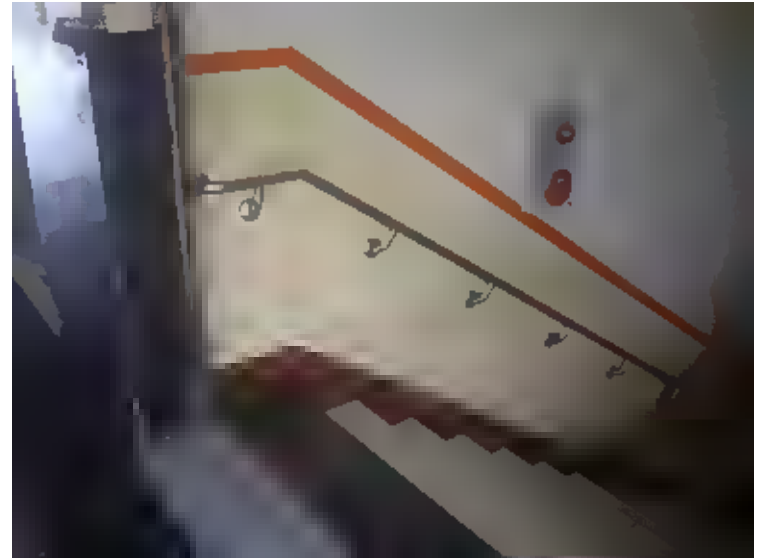

路徑線條標色

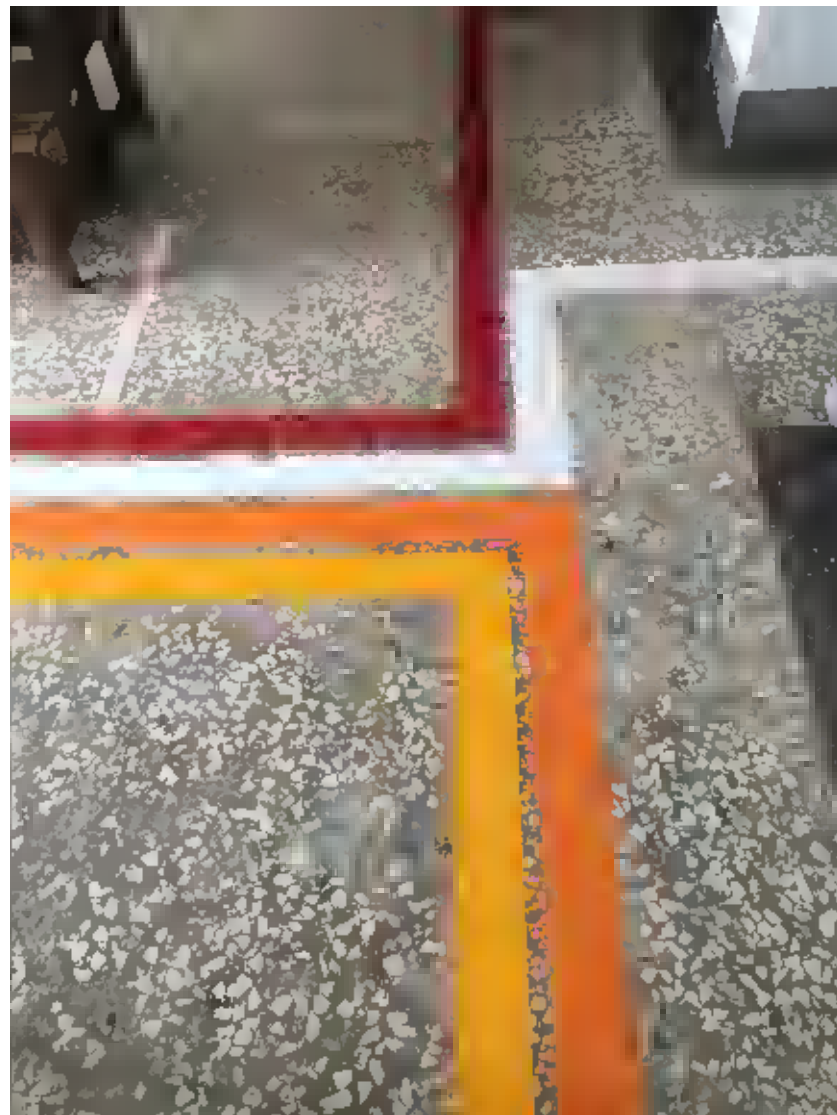

止滑、警示及顏色管理

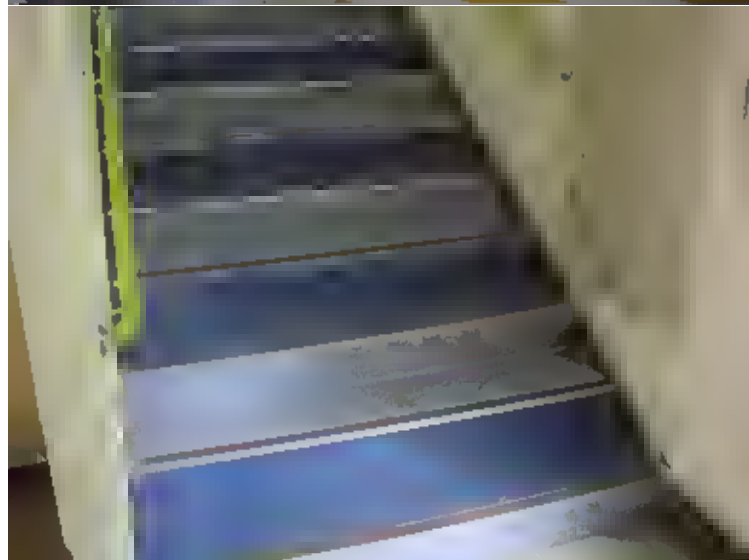
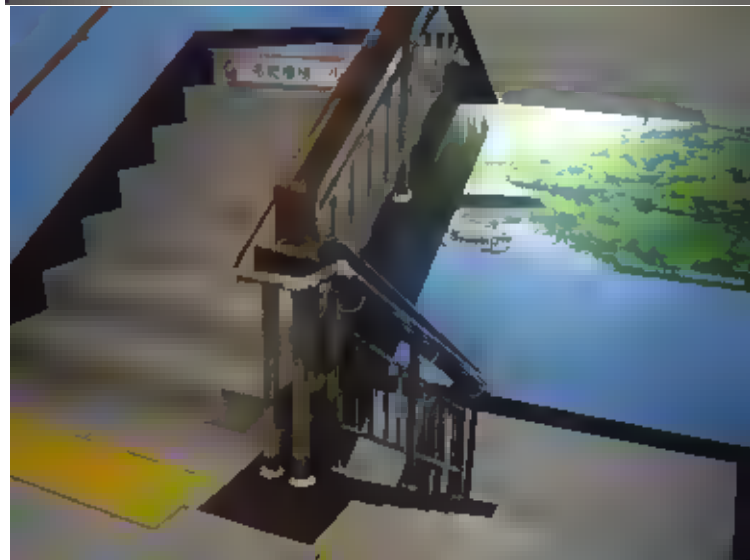
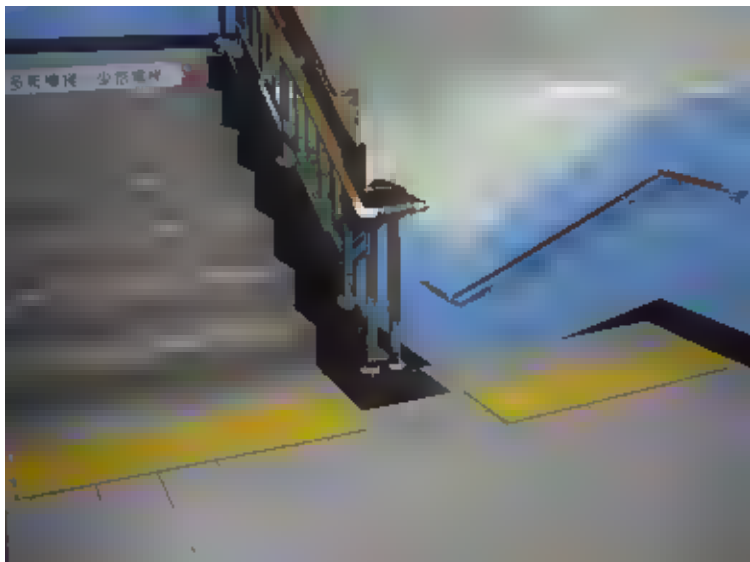

顏色區分

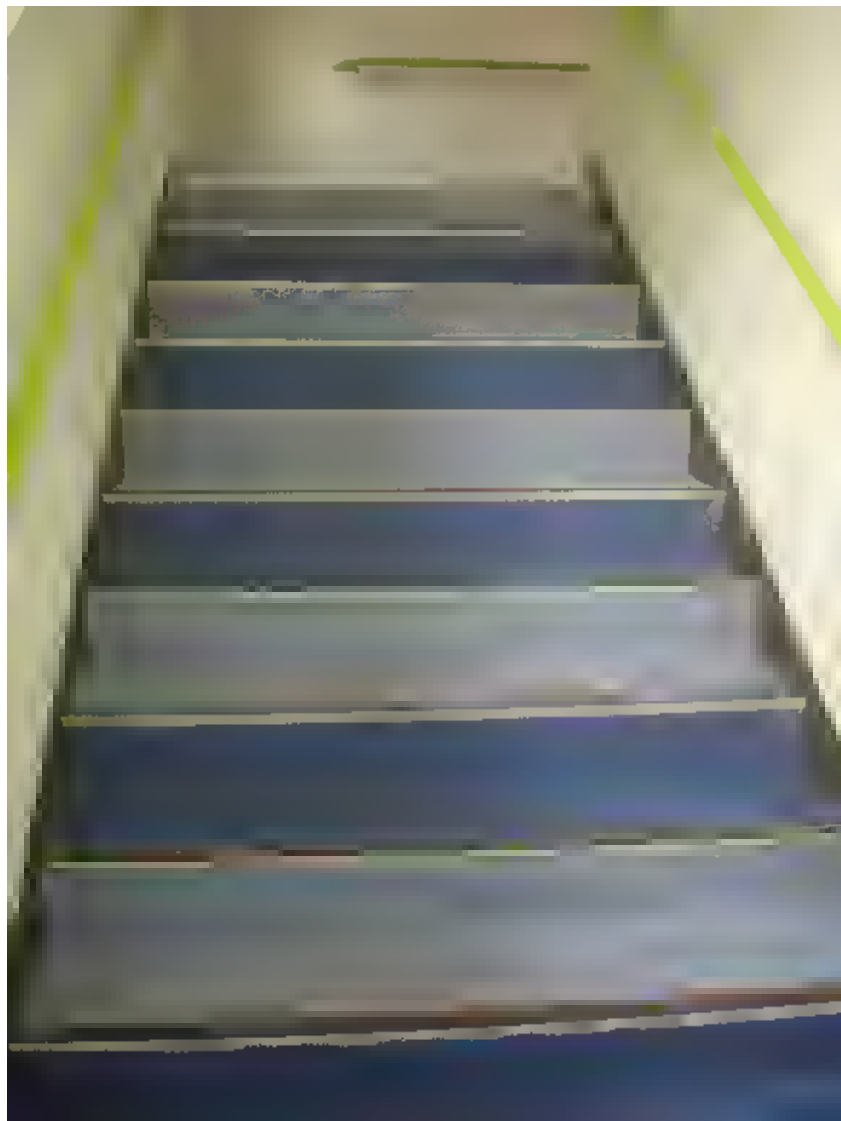

為何扶手要細

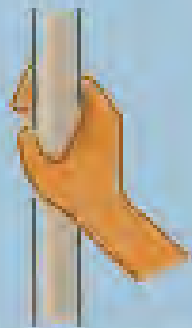

(ϕ 28~35mm)



(ϕ 30~40mm)

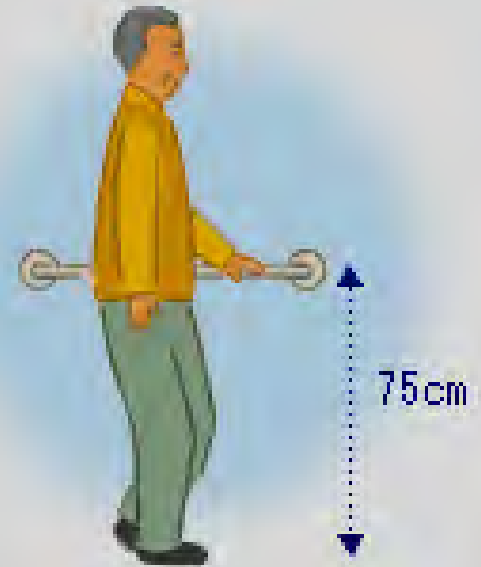

75cm

樓梯規定

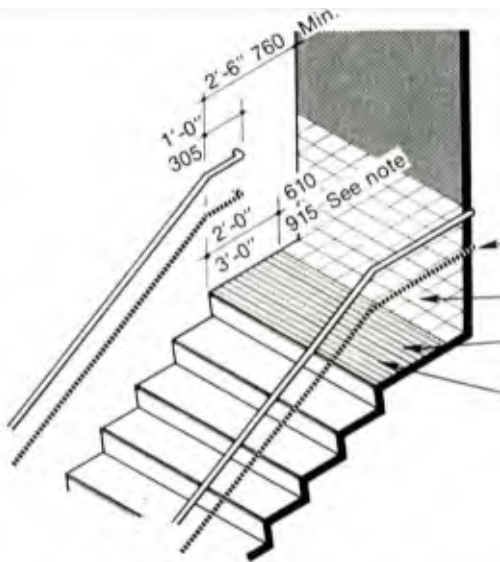
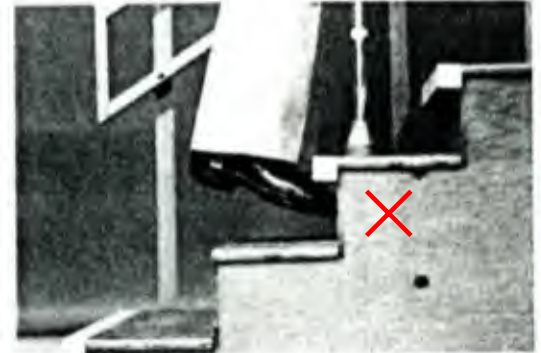
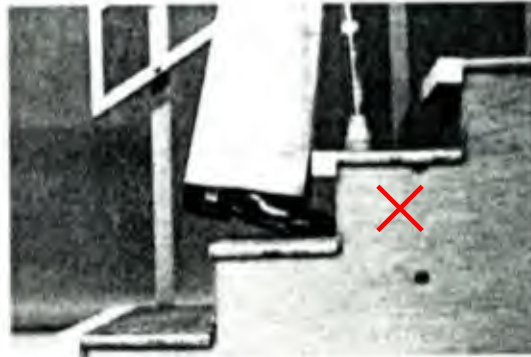

Figure 6.2.4
Requirements for a stairway intersecting
a circulation route

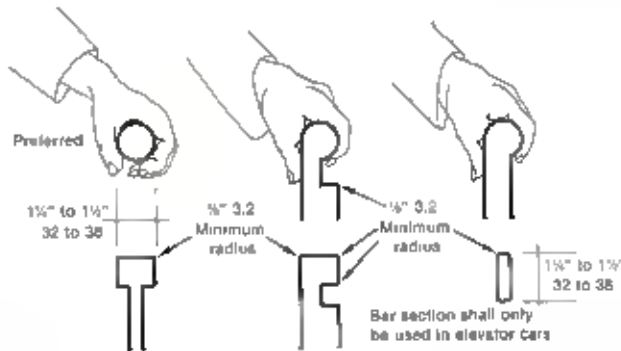

Figure 6.3.3
Sections through acceptable handrail profiles—graspable part only.

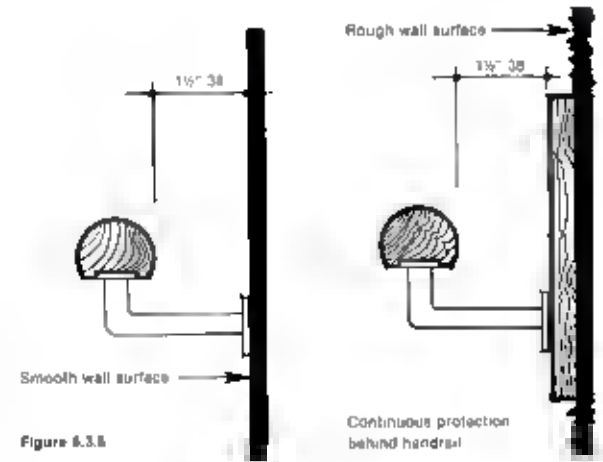
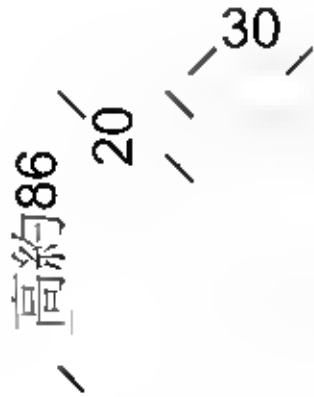

Figure 6.3.5

扶手處理



扶手端點
固定於牆上

30

為使扶手平順相接
於平台處往上方方向30
應退一踏。

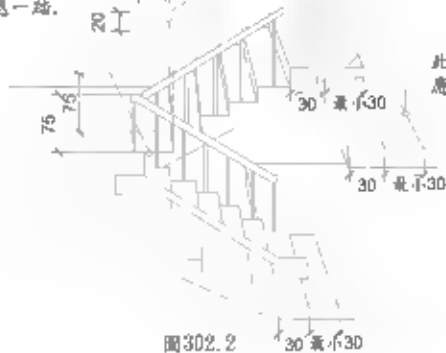

此處有向上踏步時，
應設置警示設施

圖302.2

30 最小30



樓梯警示區日本

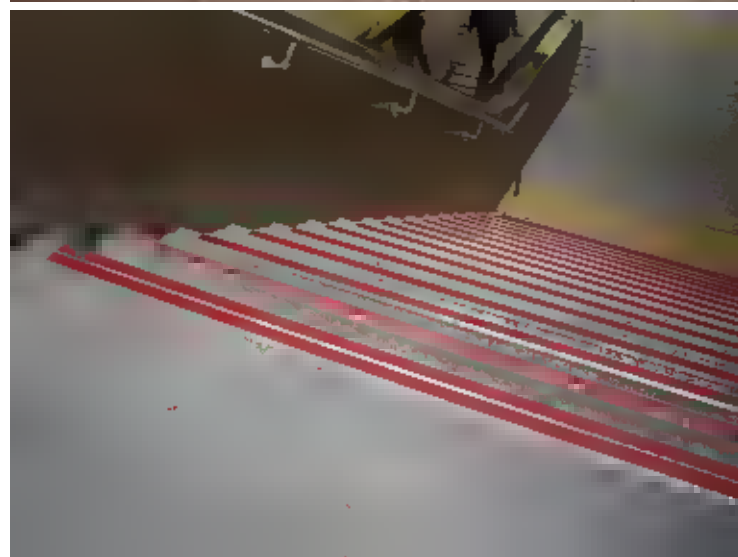

樓梯細節處



- 樓梯鼻端抬高0.3~0.5公分，會讓步伐順暢省力。

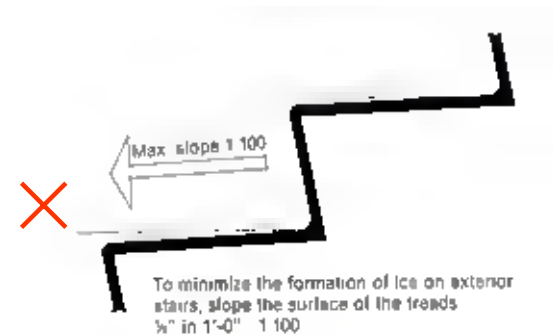

梯級鼻端上翹實例

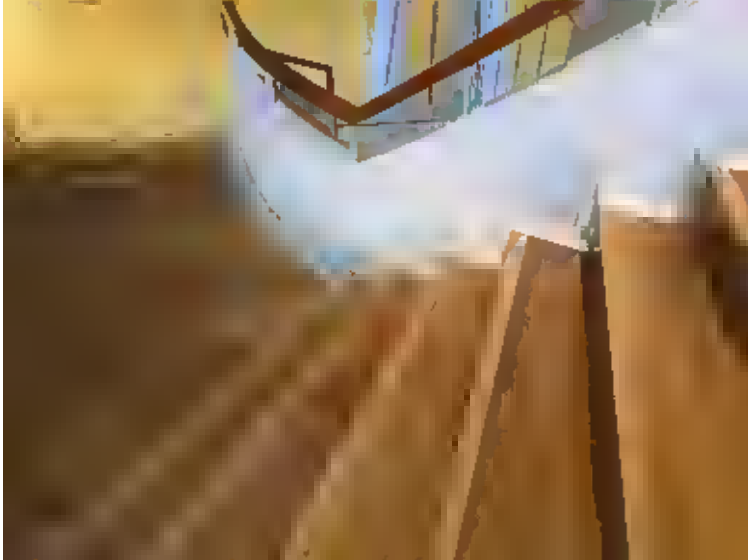

扶手



圖404.2.3



圖404.1.2

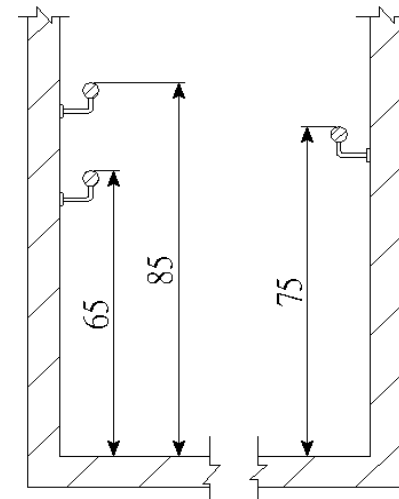

圖404.2.2

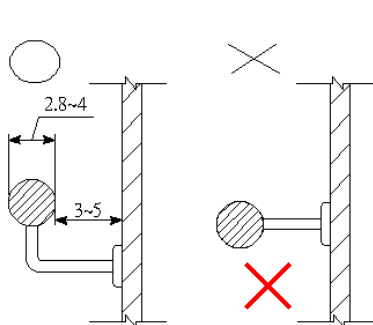

上踏步退一階加入平台

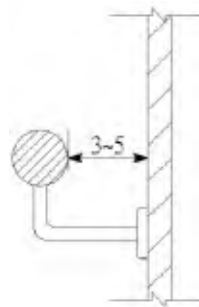
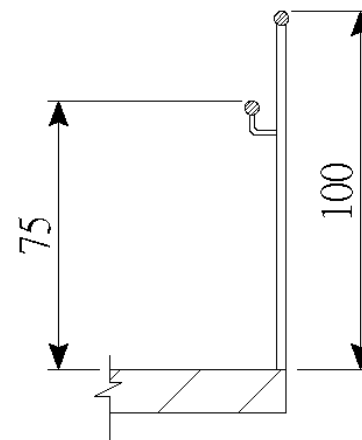
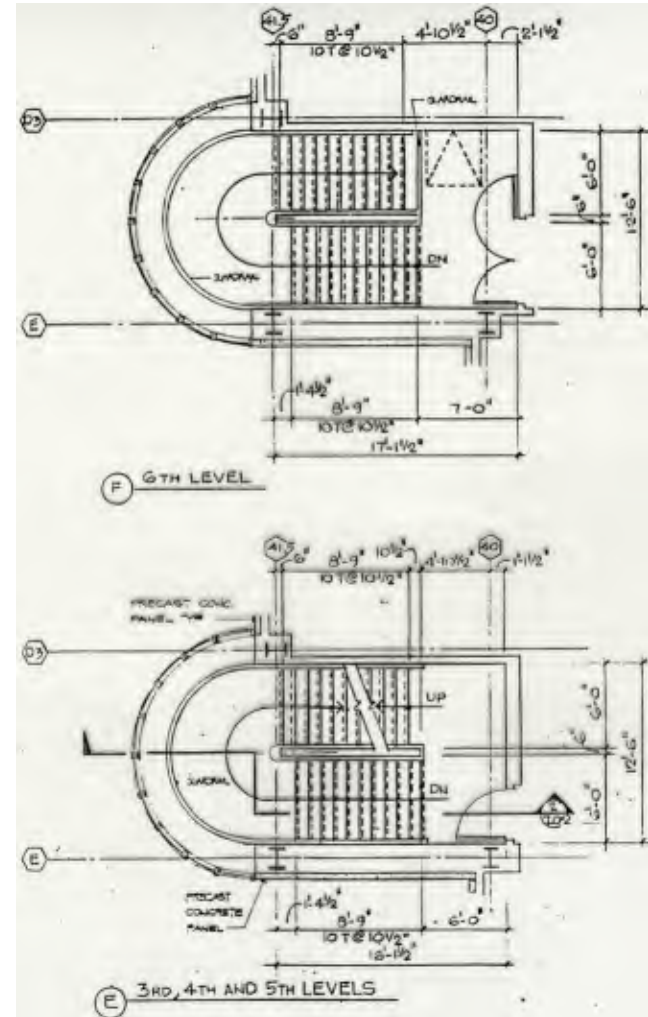
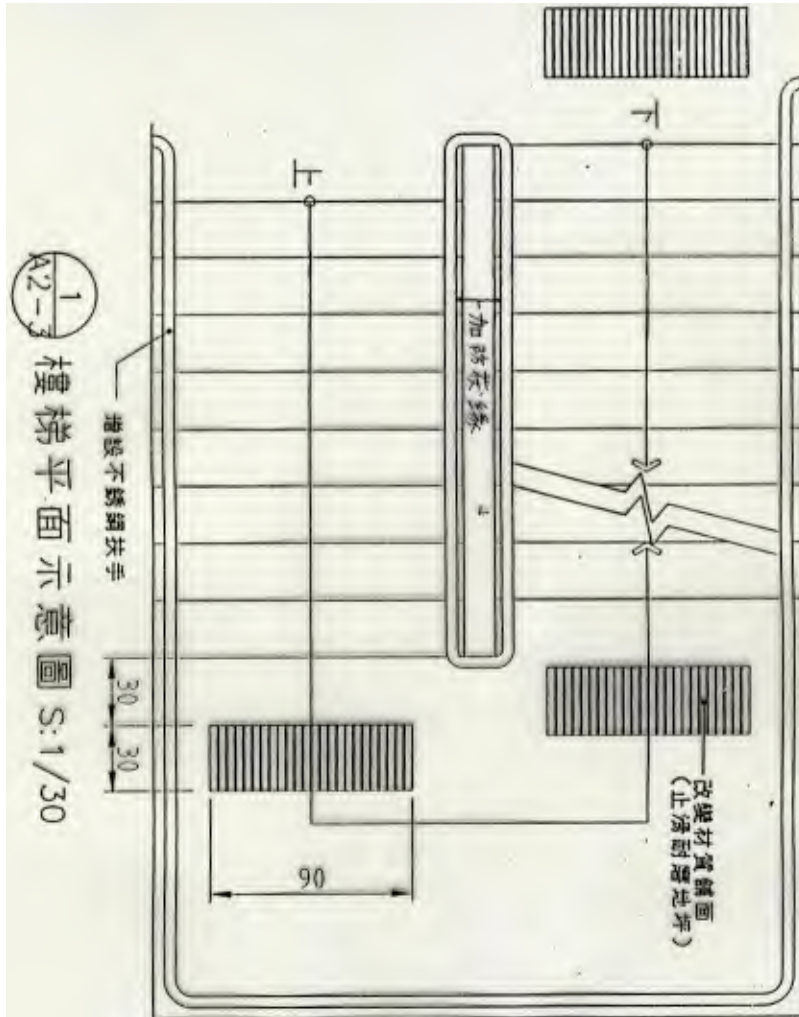

老人院扶手



樓梯止滑處理日本

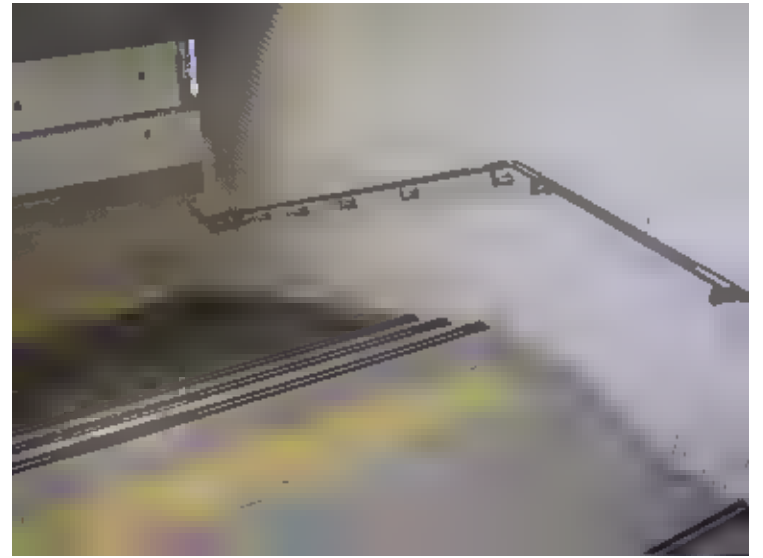
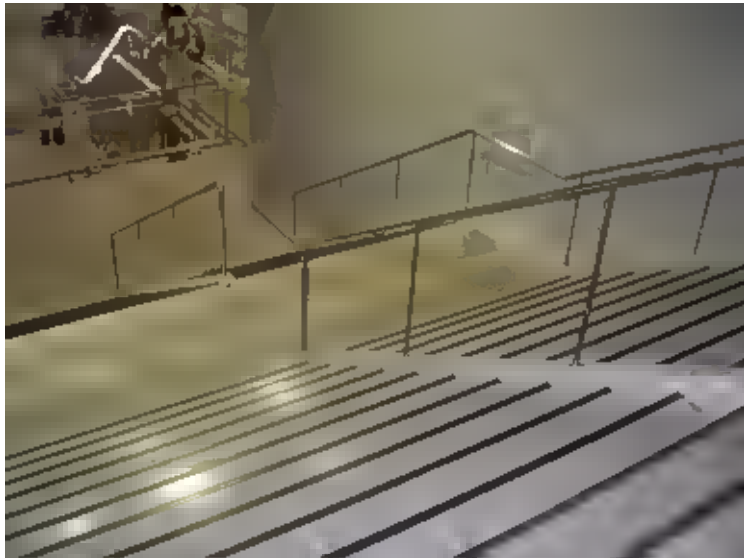

只是警示沒有止滑



□ 止滑、引導應凸出3-5mm且顏色明顯不同

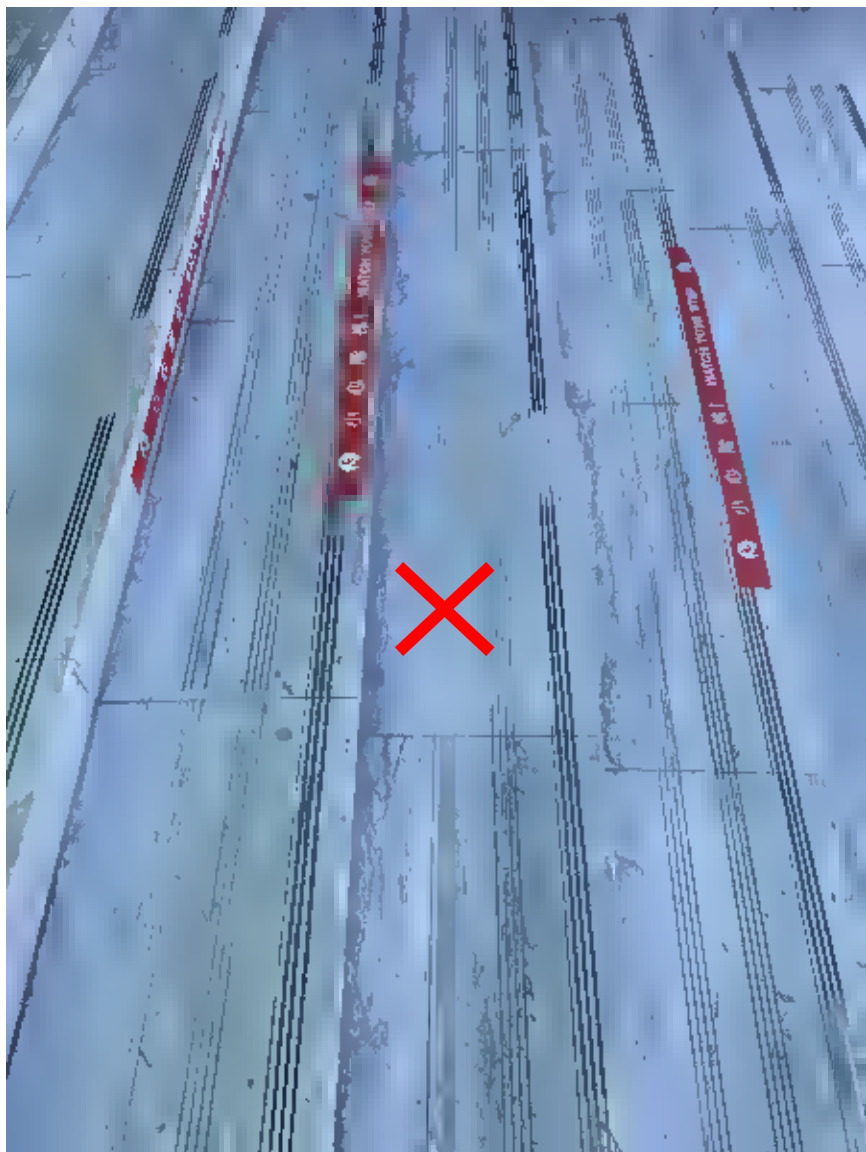

□ 凹紋增改為凸紋 應凸出3-5mm

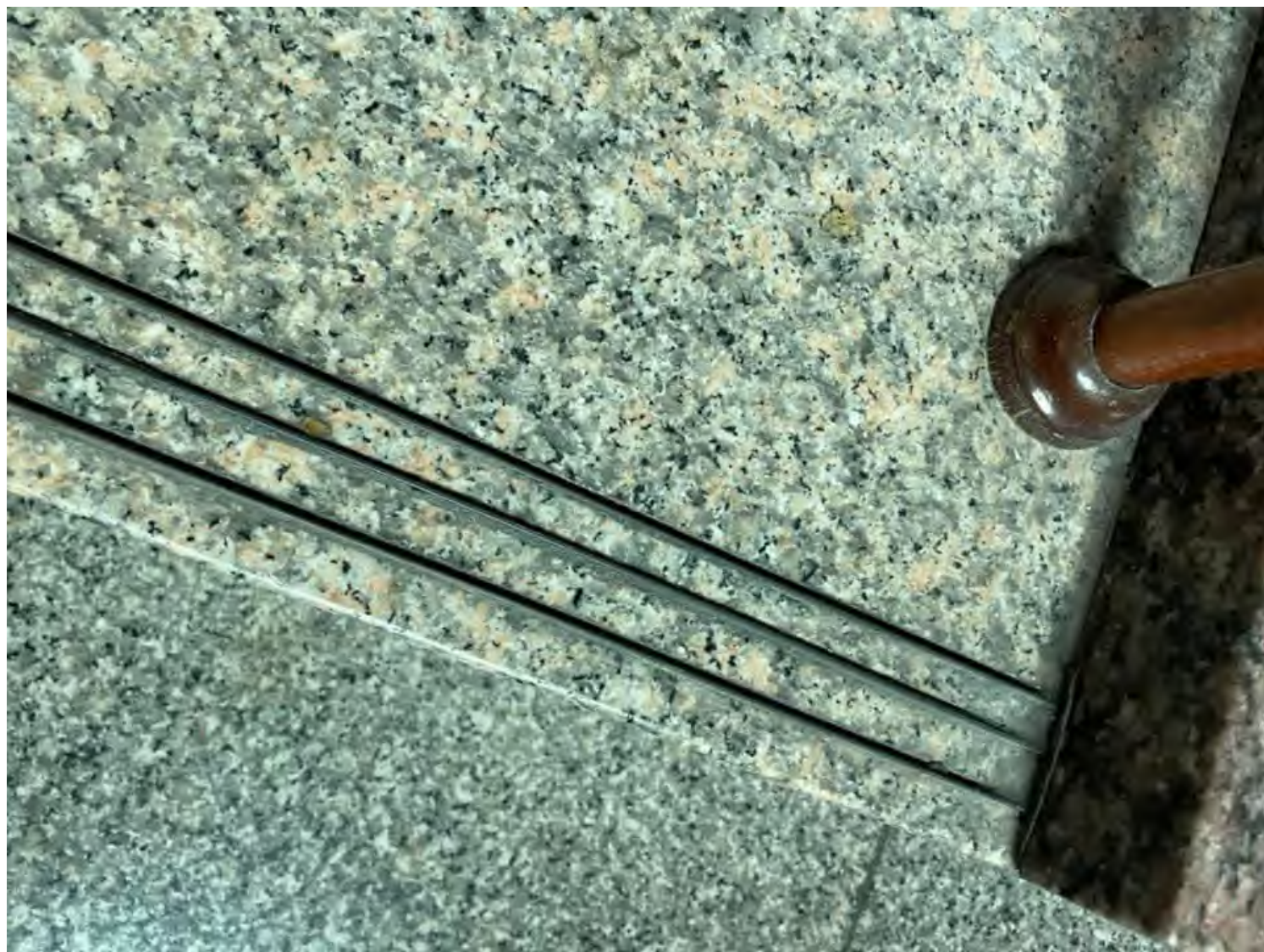

□ 即刻改善梯級明顯顏色

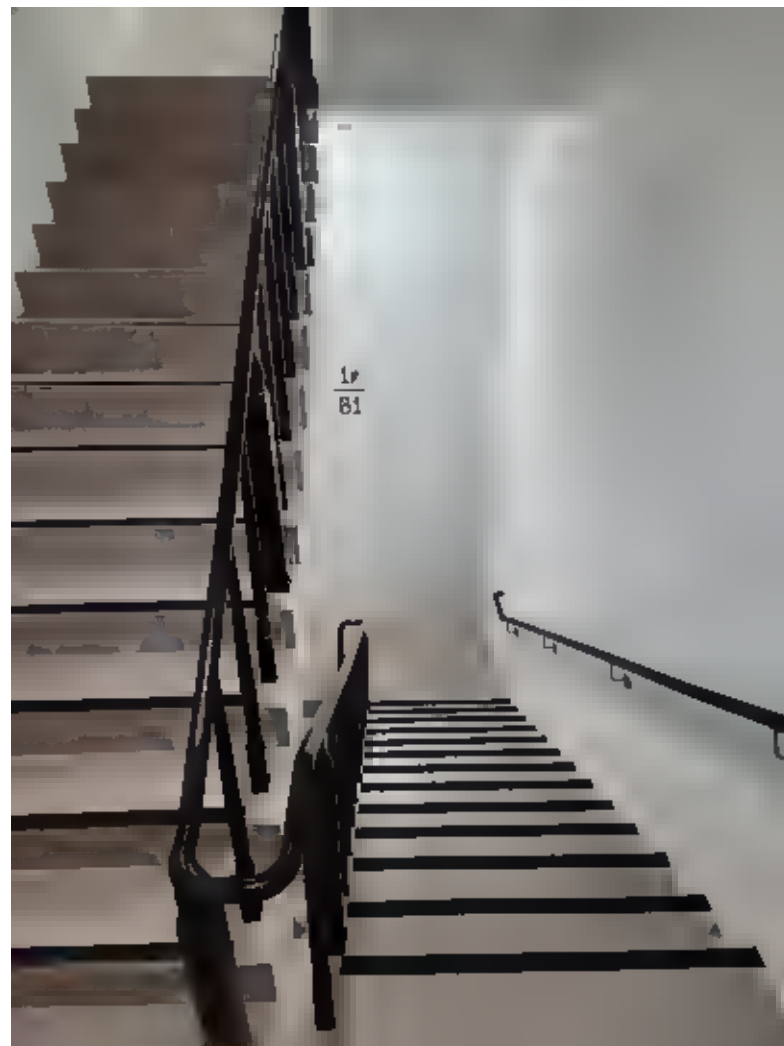
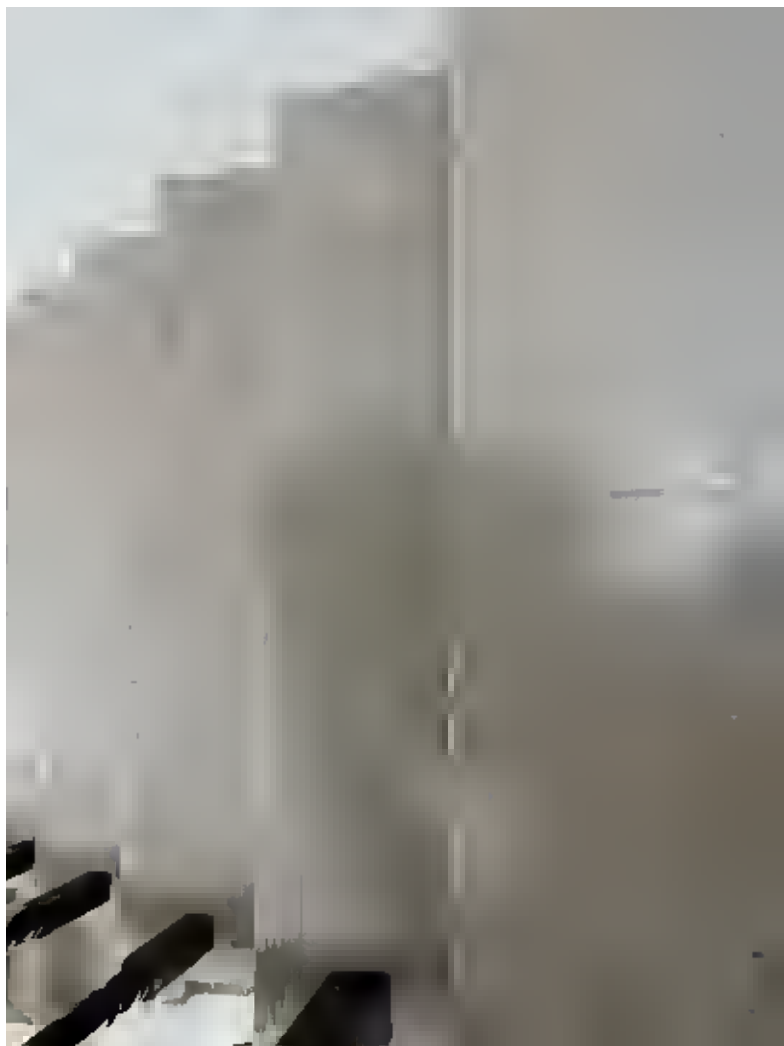

木棧道的警示線



- 「**跌倒**」屬老人事故傷害死因第2名，國健署調查約每6名老人中，就有1人在過去1年中有跌倒經驗，發生地點前3名依序是**臥室**、**客廳**、**浴室**。
- 老人嚴重跌倒可能會造成長期臥床甚至死亡，65歲以上老人自述過去幾年曾跌傷且有就醫者佔8.4%，跌傷就醫後僅約2成長者會**注意提升居家安全**。
- 老人跌傷地點，室內第1名為臥室（35.6%），第2名為客廳（30.8%），第3名為浴室（17%）。
- 室外跌傷地點第1名為街道或路上/路邊（62.9%），第2名為公園或運動場或溜冰場（10.4%），第3名為菜園或農地（9.4%）。
- 老人跌傷的原因：第1名為**滑倒或絆倒**（43.2%），第2名為**失去平衡或頭昏**（37.1%），第3名為**碰到或撞上物品或人**（11.7%）。

□ 地板材料與滑倒的認知



- 水泥地坪、陶質地磚、石質地磚、磁磚、瓷質地磚、大理石地坪、木地板、橡膠地板、塑膠地板。
- 吸水率：**0.5%~6%**。
- 防滑係數：穿鞋時**C. S. R.**應在**0.45~0.7**。
- 跌倒地點：浴室、淋浴間、廚房、陽台。因為水、食用沙拉油、洗劑、肥皂水、洗髮水。

□ CNS3299-12陶瓷面磚止滑係數

空間類別	室內/戶外	防滑係數建議最小值
建築基地內廣場、騎樓、無遮簷人行道、戶外樓梯	戶外	0.55 (C. S. R 值)
建築物之走道、出入口、門廳、樓梯	室內	0.5 (C. S. R 值)
居室	室內	0.45 (C. S. R 值)
廁所盥洗室、浴室、游泳池畔、沖洗室、更衣室等之地坪	室內/戶外	0.7 (C. S. R · B 值)

備註：防滑性能係以穿鞋時之防滑係數(C. S. R 值)及赤腳時之防滑係數(C. S. R · B 值)予以判定。

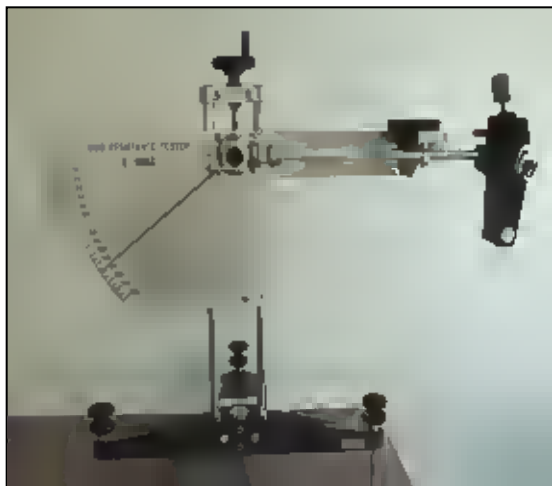

試體表面粗糙者防滑性能較佳

窯燒花崗岩



地原石



多管透心瓷磚

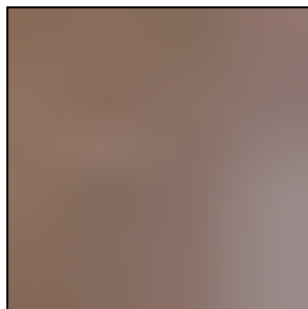

石英磚



結晶化瓷磚

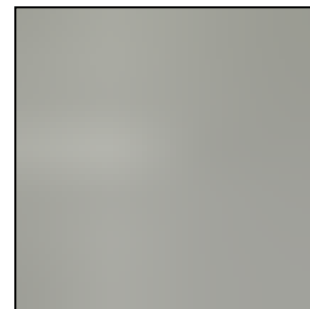

3.1.4.1 防滑性能測試方法

中央標準檢驗局已於100年9月29日發布CNS 3299-12 防滑性能試驗法，可用來量測材料之防滑係數。



CNS 3299-12
(JIS A1509-12)



可變角度止滑計

台北市政府規定103年7月1日起，建造執照有留設騎樓或無遮簷人行道者，於申請使用執照時，該等鋪面應併案檢具符合CNS 3299-12(穿鞋C.S.R.)防滑係數達**0.55**以上之檢試驗報告。

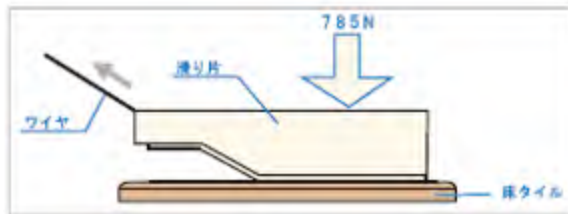

實際行走於受測地面材料



水平拉力計



ASM825

地板材料

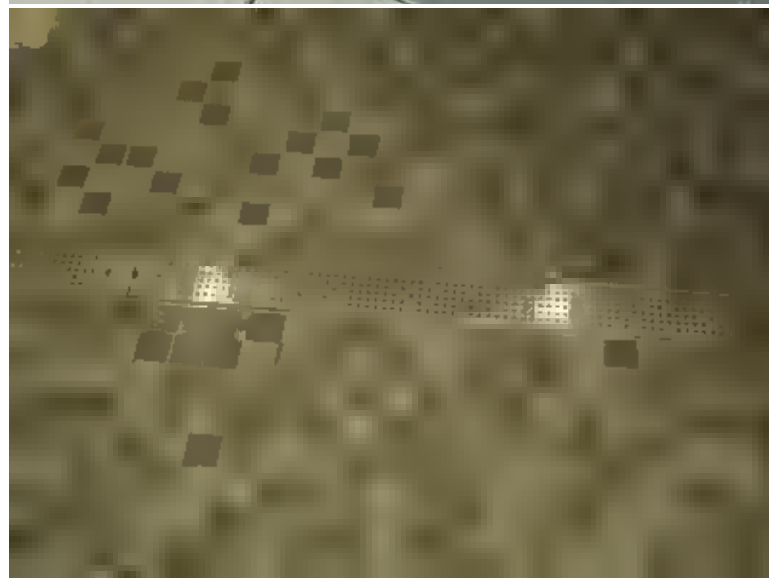

室內地面及木扶手

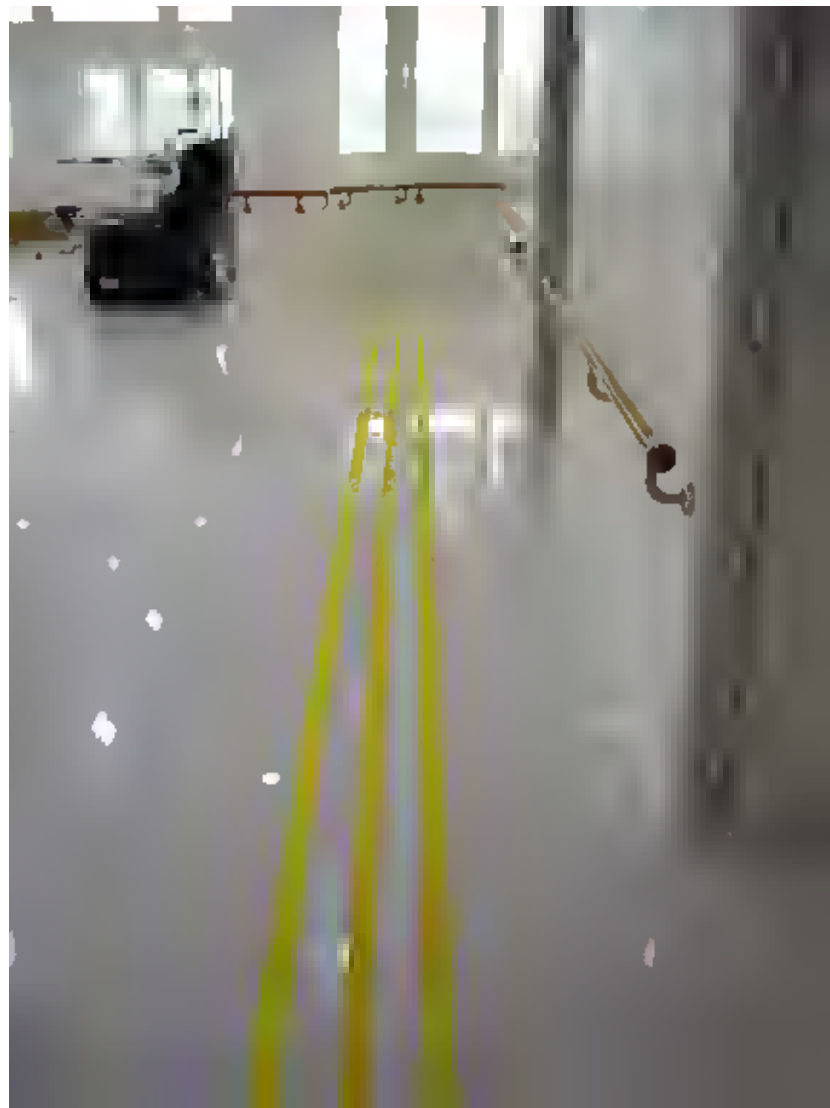
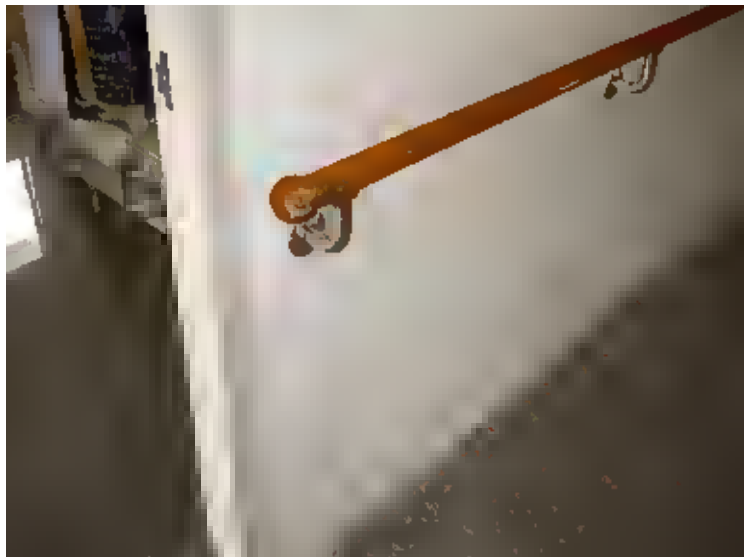

走廊扶手



走廊扶手

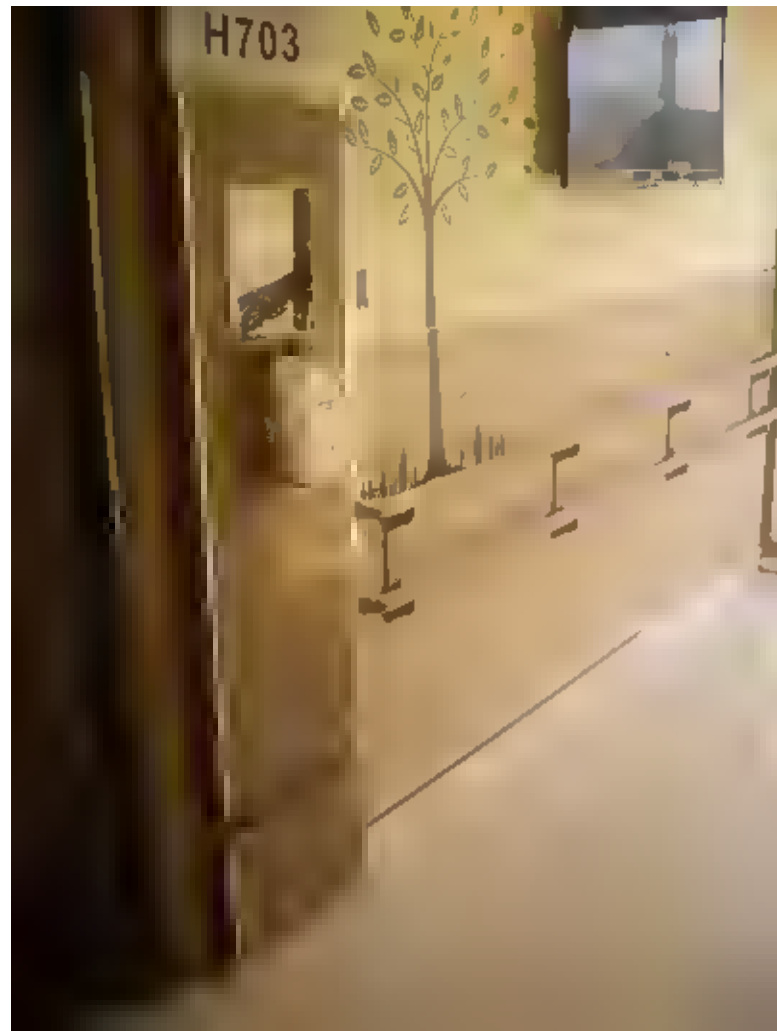

門框上色



牆角跌倒防護條



軟木地板

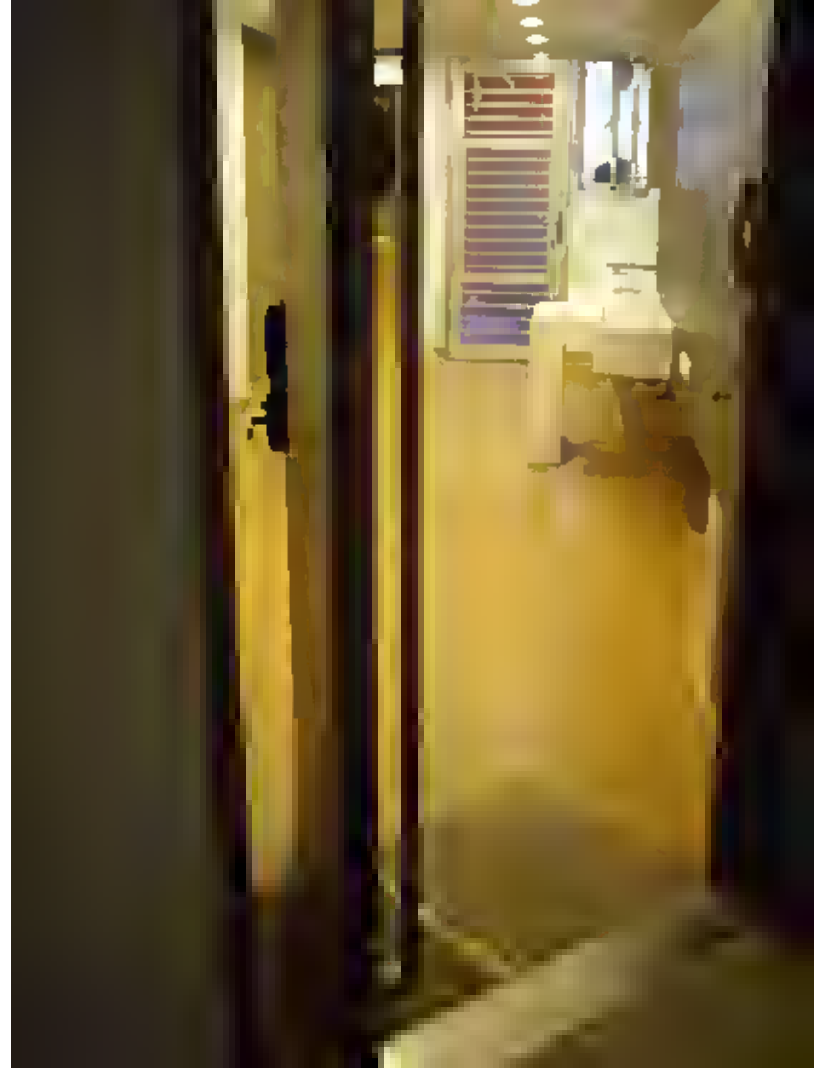

室內地板材料



室內地板材料



地板反光不佳

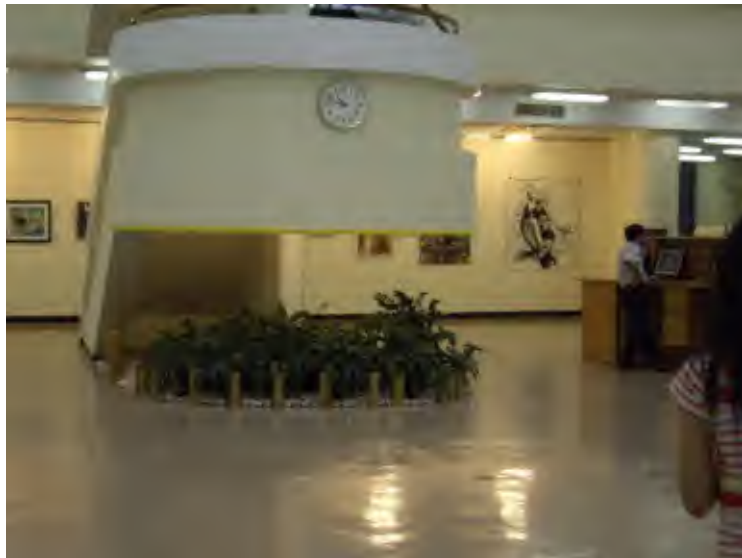

地板反光濕滑不佳



供行動不便者使用升降機2



圖403.2



圖403.3.2

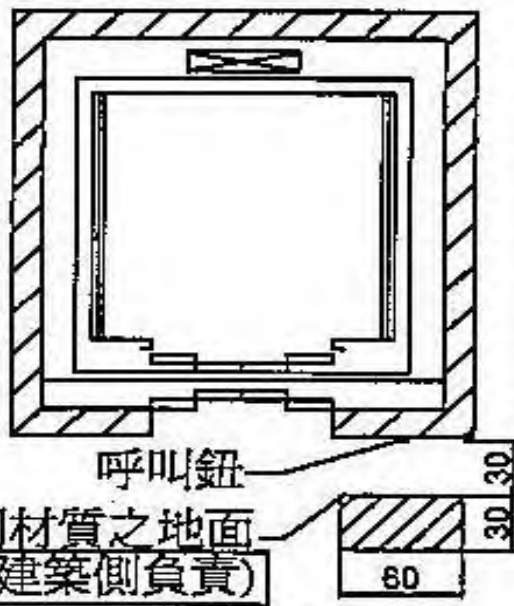

圖403.3.1

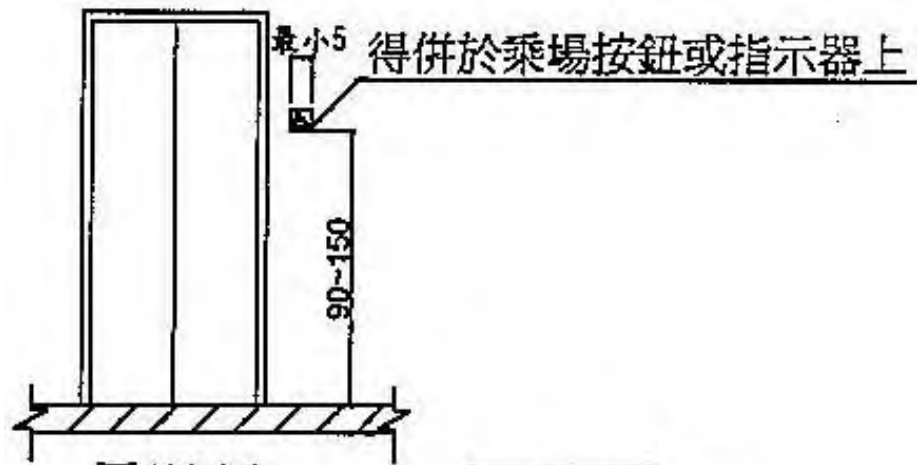

圖406.1

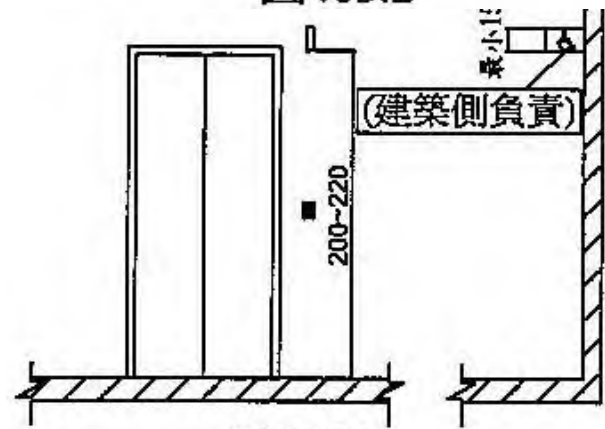

圖404.2

圖404.1

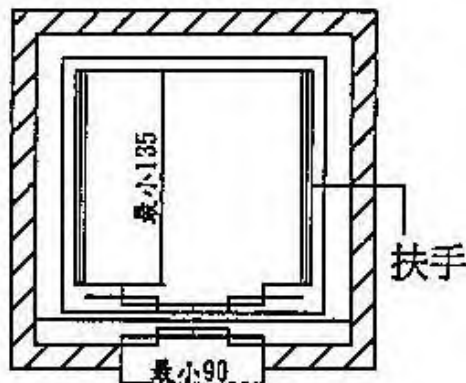
電梯相關尺寸

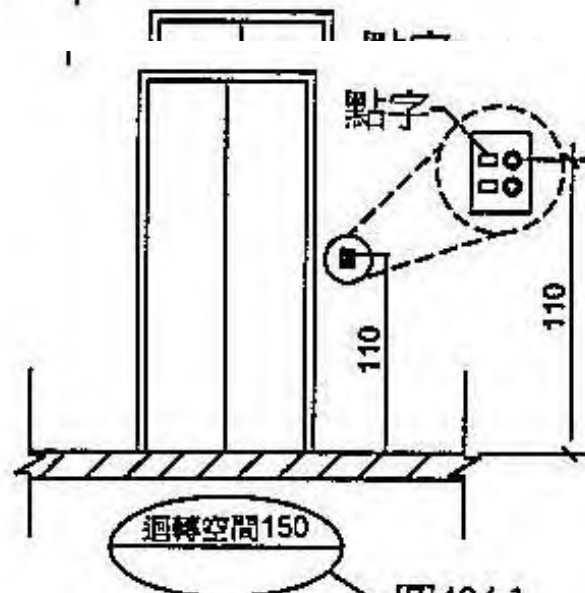

圖 307.4.1



圖 307.4.5

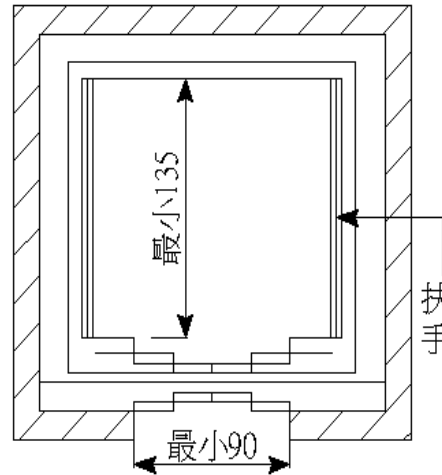
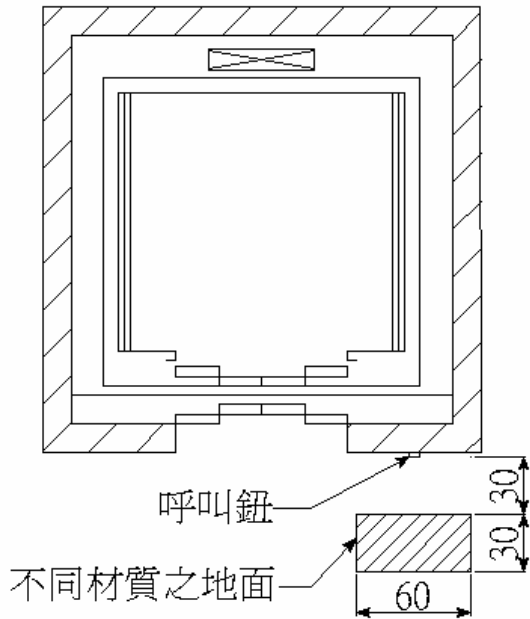

圖 307.2.4

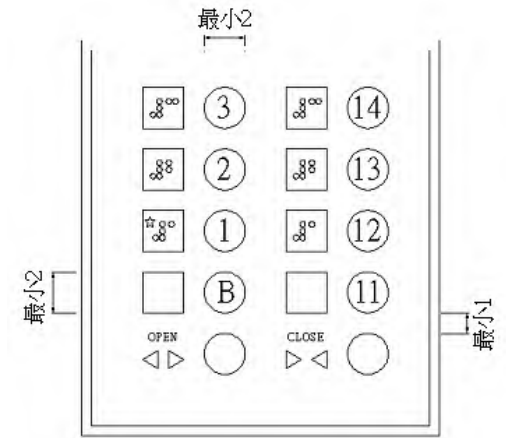

圖 307.4.4

電梯無障礙設施

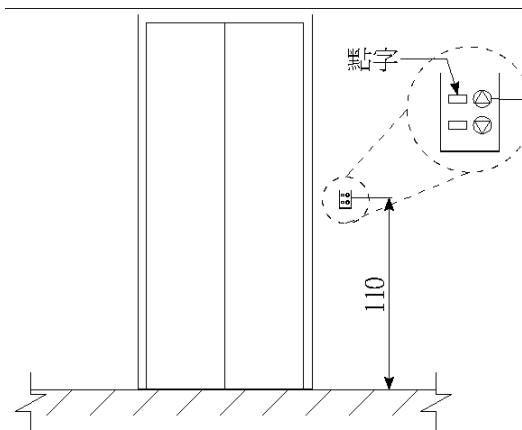
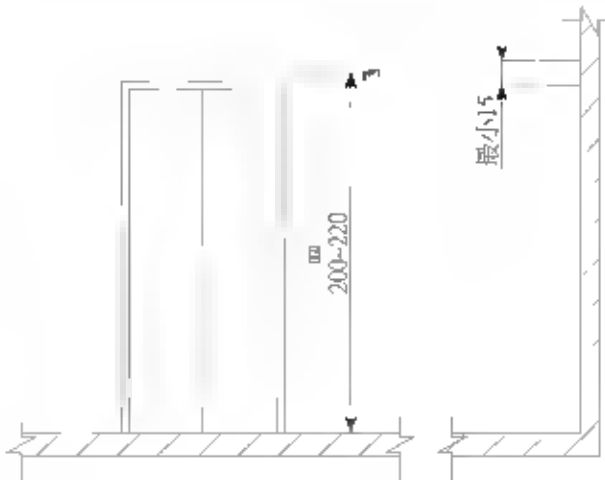

圖 307.4.4

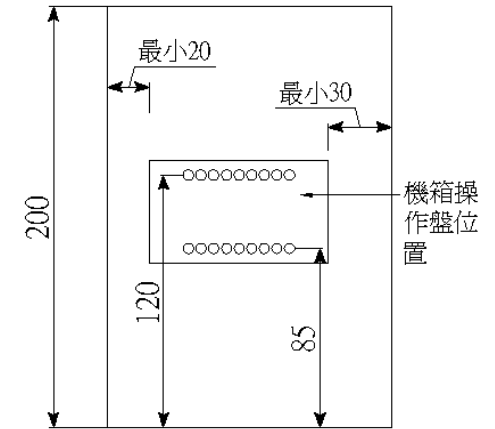

盲校老師測試點字

點字	升降機符號	點字	升降機符號	點字	升降機符號	點字	升降機符號
⠠	☆①	⠠	5	⠠	9	⠠	上
⠠	2	⠠	6	⠠	10	⠠	下
⠠	3	⠠	7	⠠	11	⠠	開
⠠	4	⠠	8	⠠	12	⠠	關

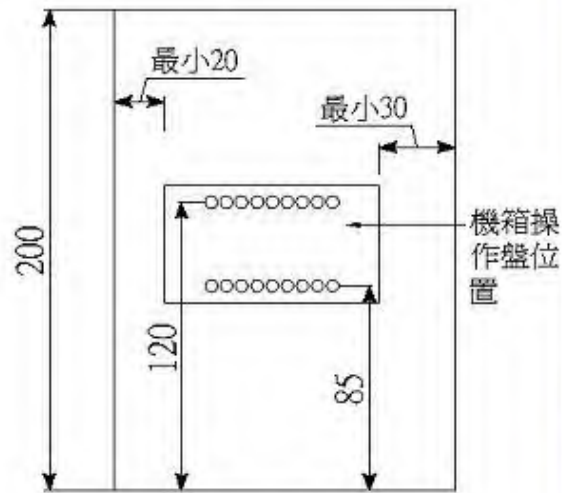
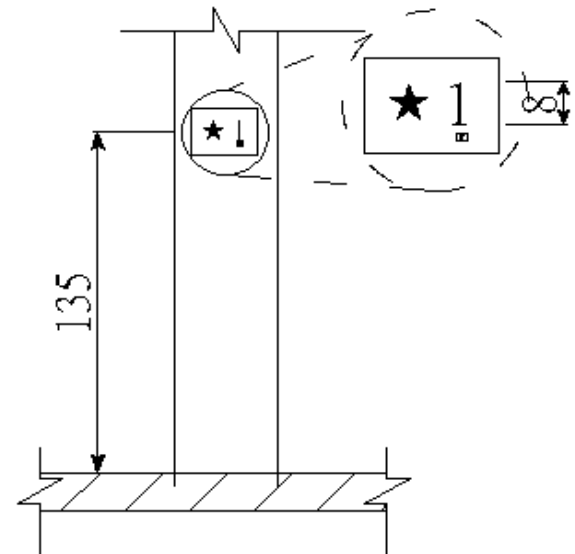

圖 307.4.5



鏡面太高

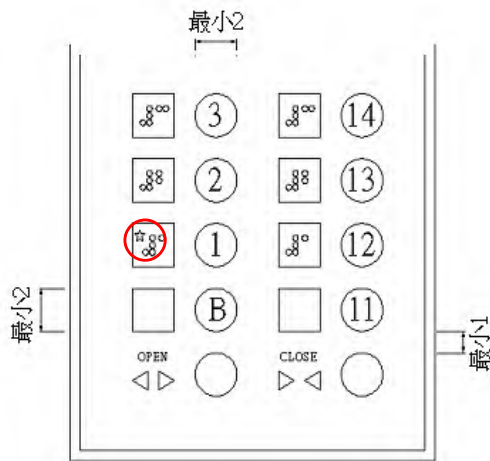

- 輪椅要倒退出電梯，所以要降低鏡面以便後視。
- 透明電梯也可以利用後視鏡，達到相同效果。

色差對比

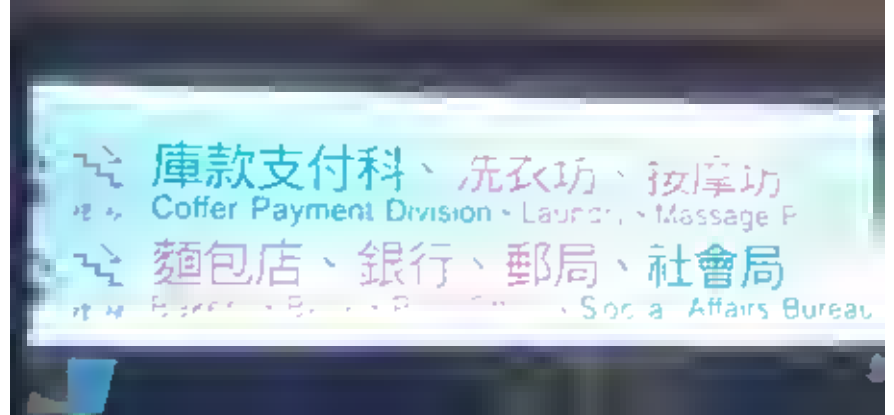

色差的需求

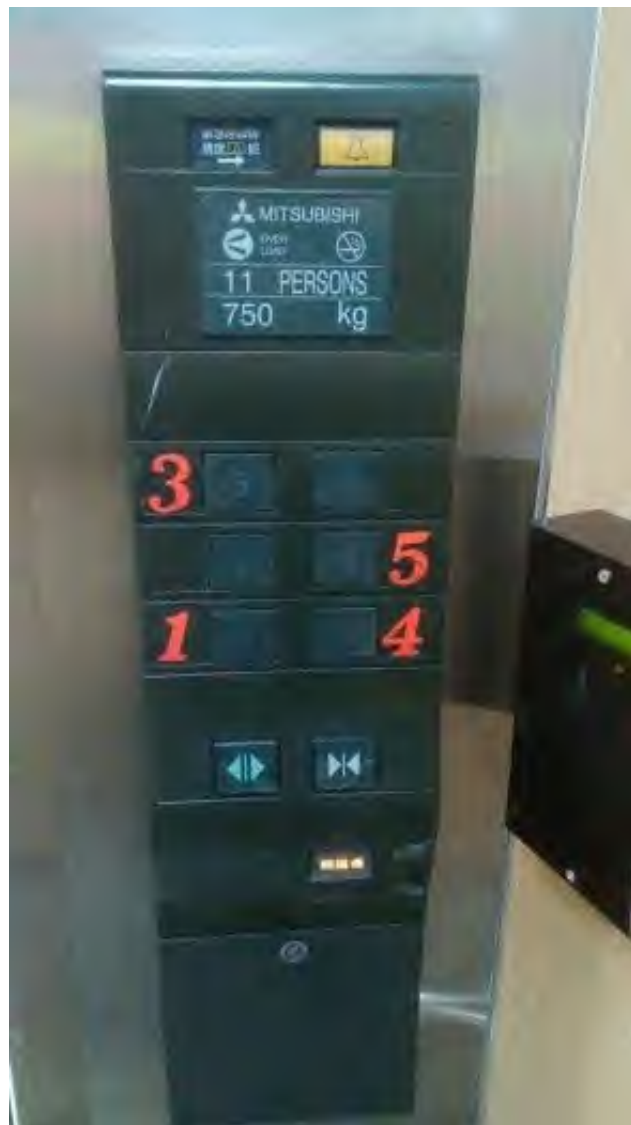

到達樓層提示

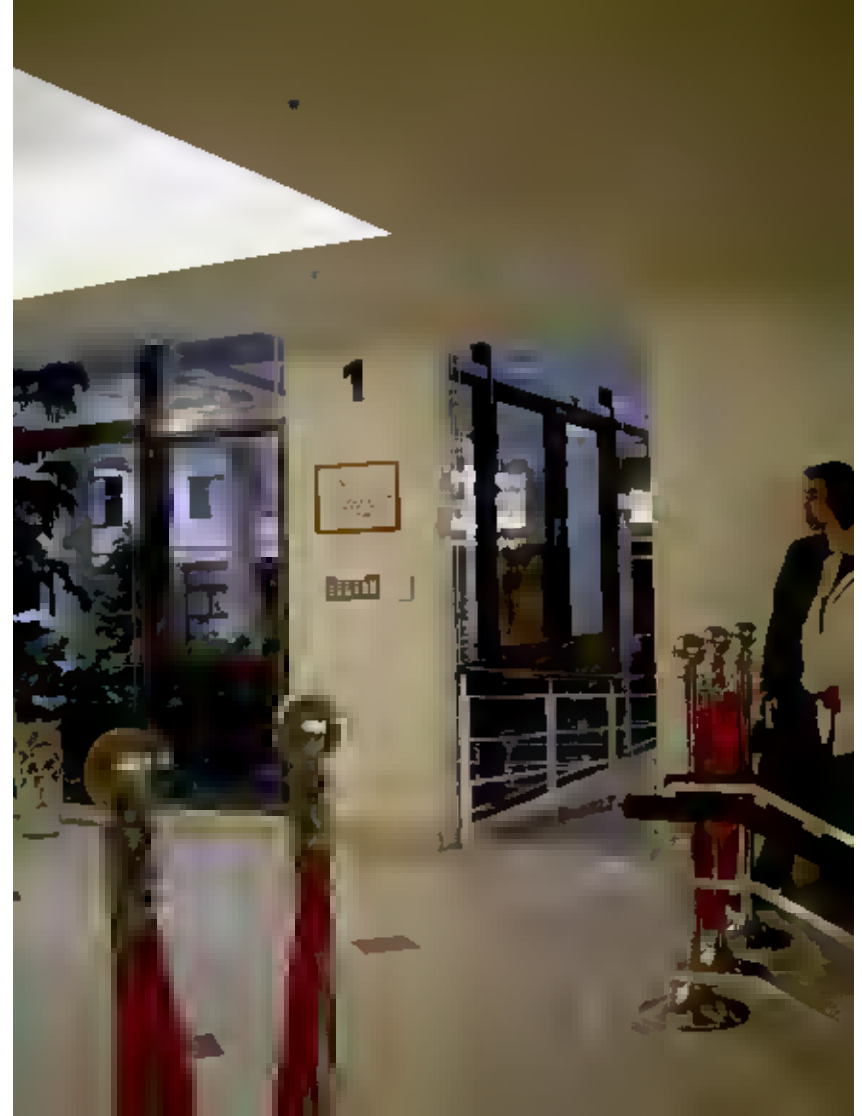

樓層數字

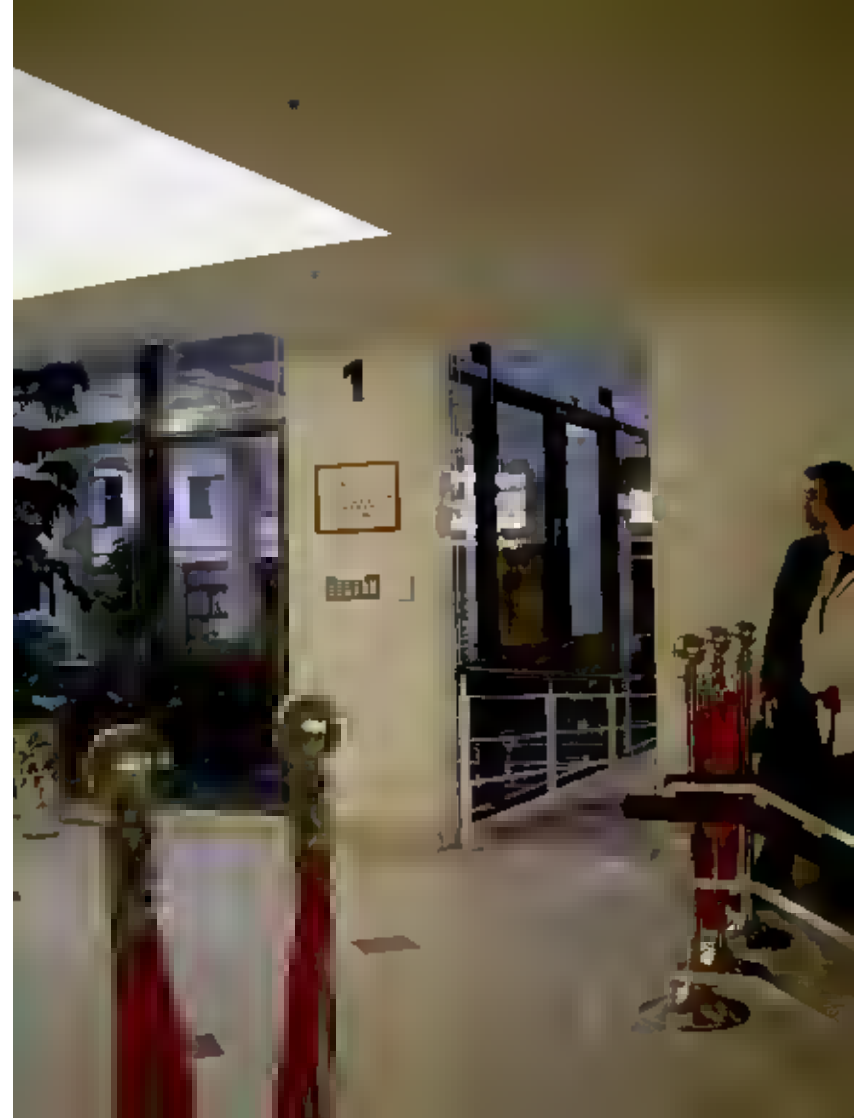

半層輪椅升降機



單一輪椅升降機



輪椅垂直升降機

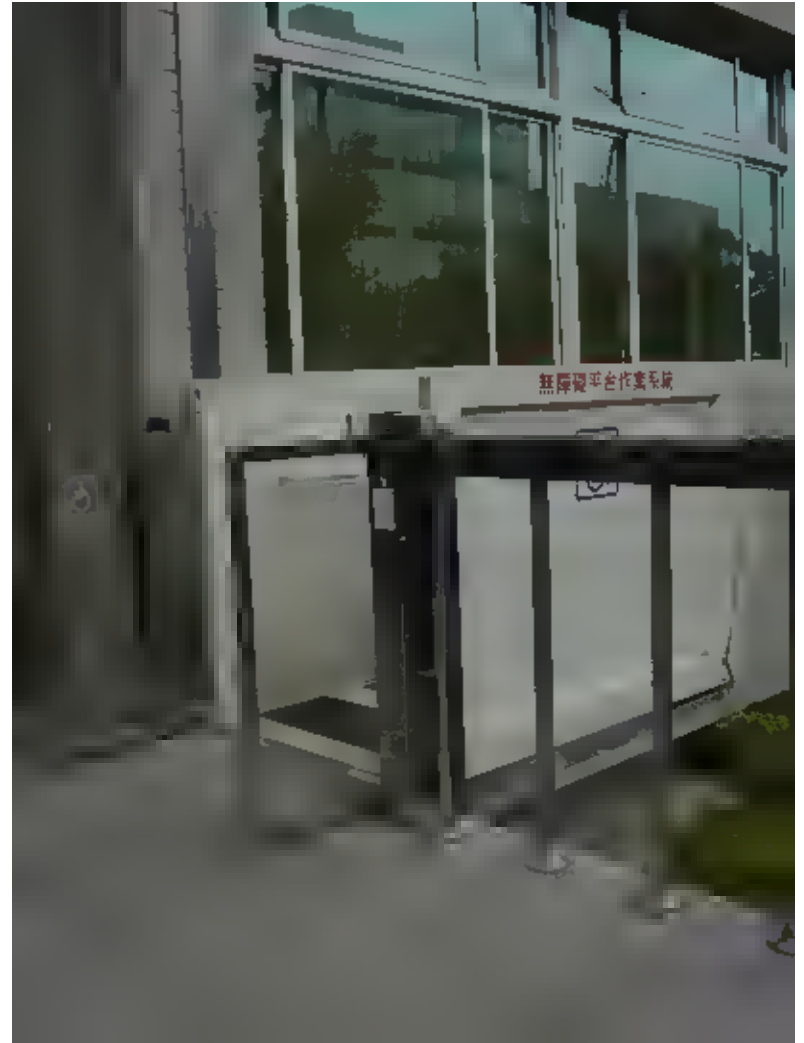

輪椅升降設備



輪椅輔助設施



輪椅乘用電扶梯



住宅改善懸臂式輪椅升降台

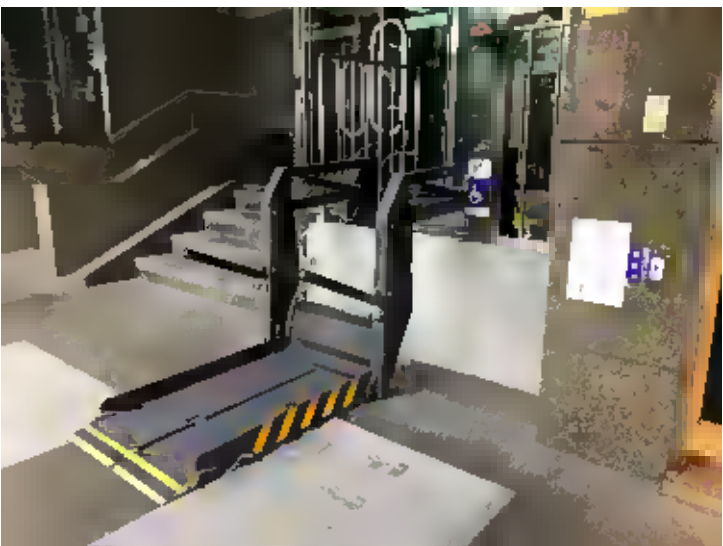
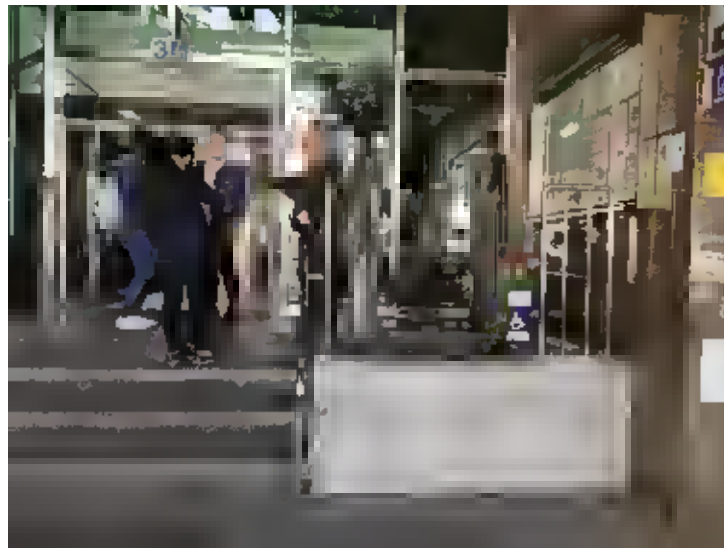

輪椅垂直升降機



輪椅垂直升降機

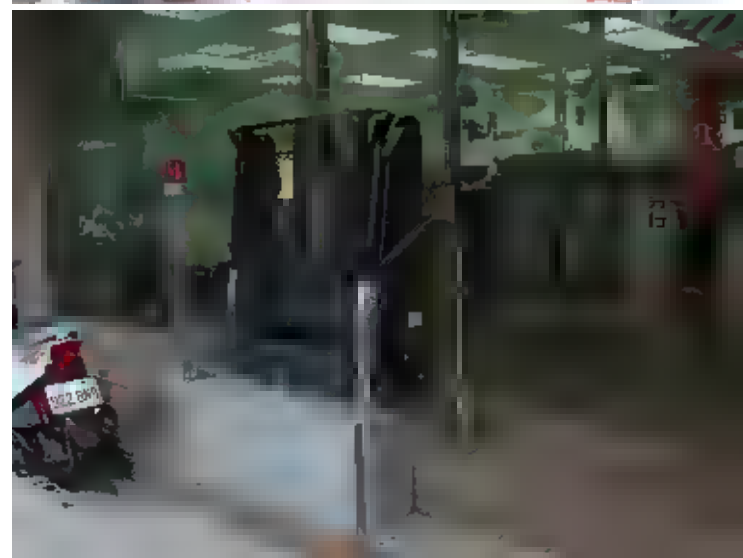

樓梯附掛式輪椅升降平台

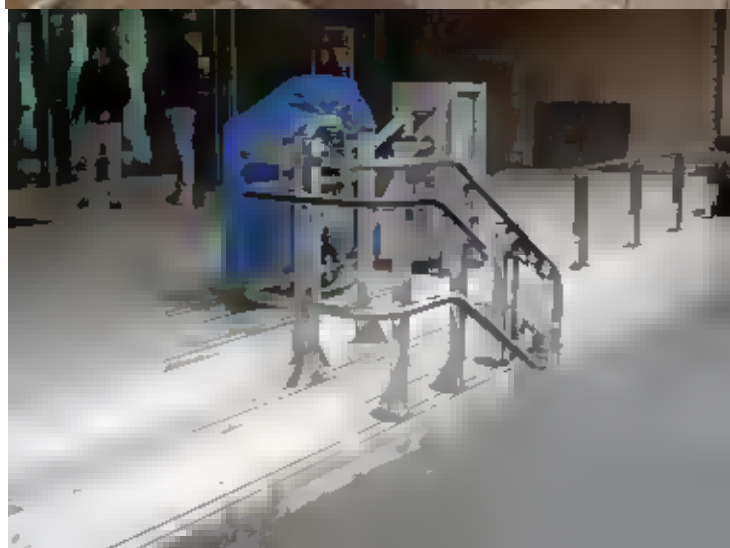

樓梯附掛式輪椅升降平台



樓梯附掛式輪椅升降平台



樓梯附掛式輪椅升降平台

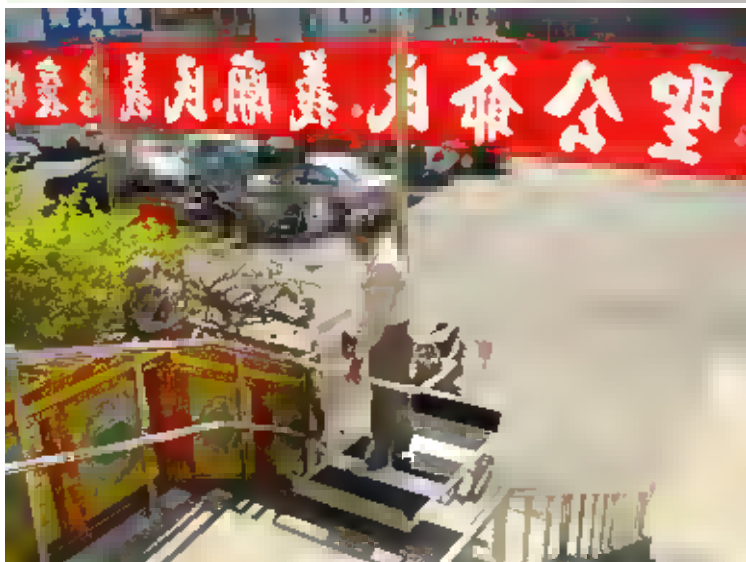

樓梯附掛式輪椅升降平台

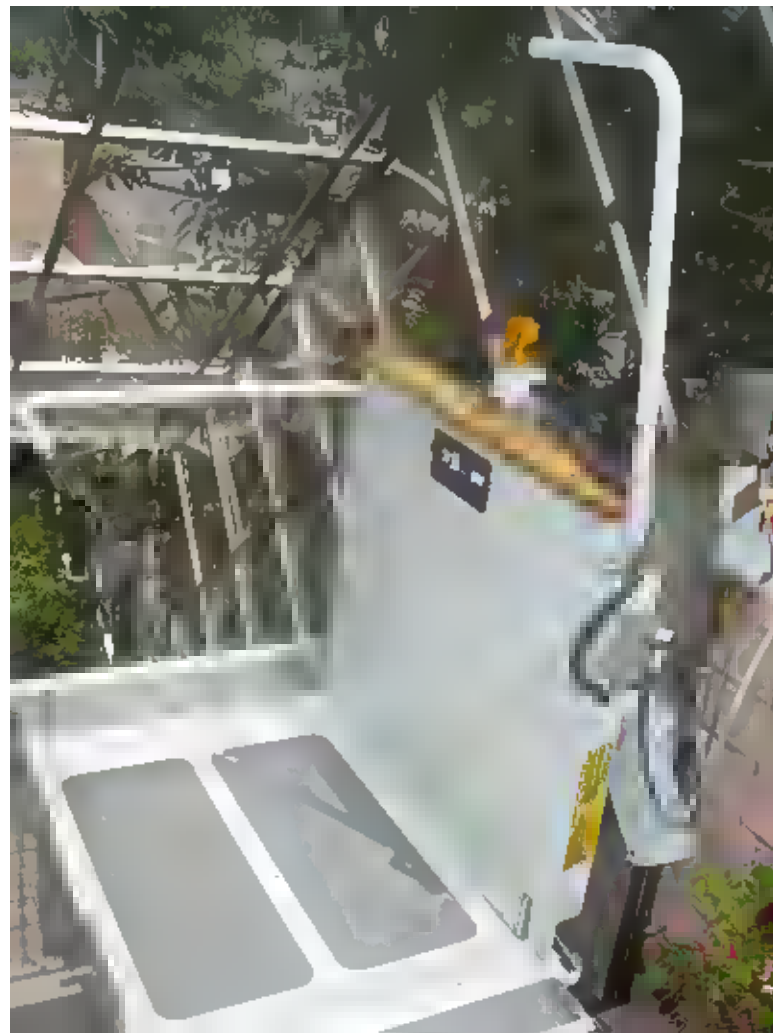

樓梯附掛式升降椅

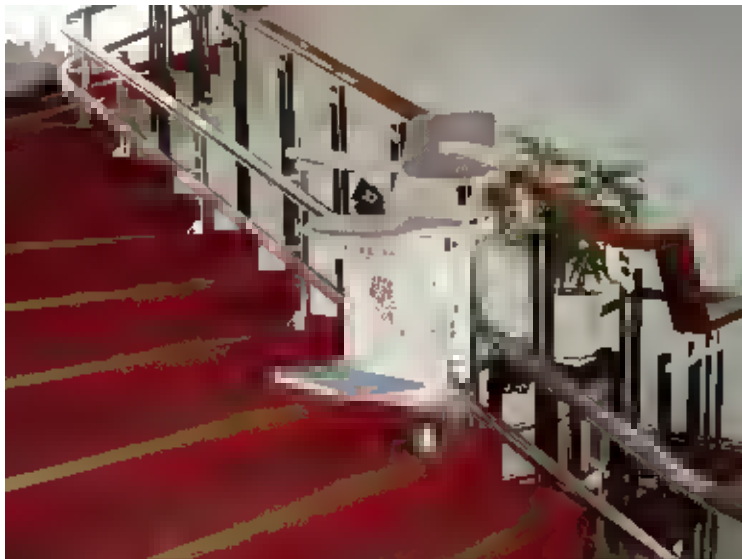

輪椅輔助設施



日本爬梯機



日本爬梯機

SUNWAの福祉機器

老人用階段昇降車

ステアチェア
STAIR CHAIR

特許:第1521028号 主要7ヶ国取得済

ISO 9001 認証対象商品

■ステアチェア (SC-1)

最大体重	110kg/1名
重量	47kg(バッテリー含)
全(長×幅×高)	1,293×411×936(mm)
// (収納時)	1,093×411×503(mm)
バッテリー	12V-17Ah
使用時間	約30分/一充電当り
速 階段上昇	約19段(6.0m)/分
度 階段下降	約30段(9.4m)/分
最大階段角度	35度

歩行困難な方のために
介護者1名で安全に
階段の昇降ができる

- 狭いスペースの踊り場でも使用できるポータブルタイプ
- ワンタッチでバッテリーパックの交換ができます

新製品

SC-1型

ワンタッチ折りたたみ式

●平均は4個の車輪で軽く手摺り、階段アは



扶手高度要考慮



老人需要扶手撑立 15~22cm



老人需要扶手撑立

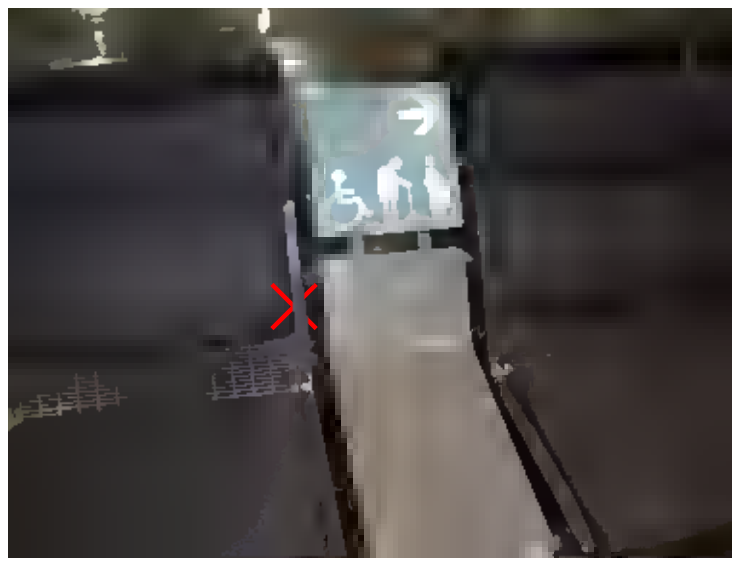

候診椅



多種功能的休息椅

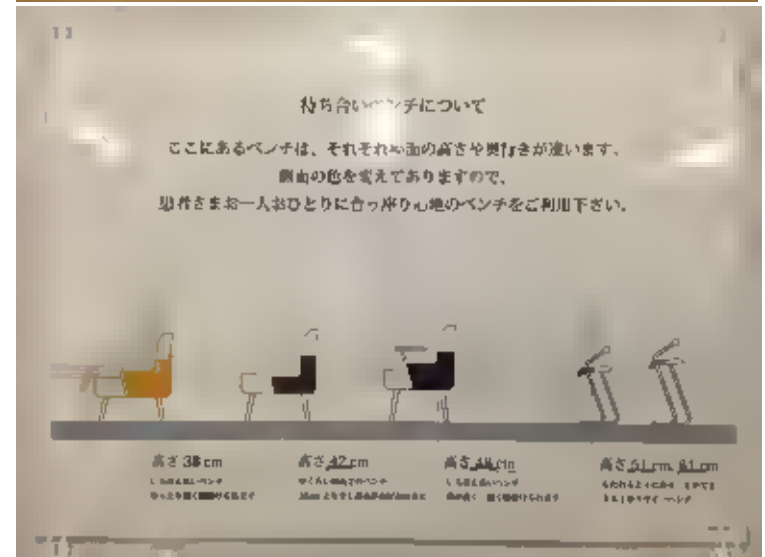
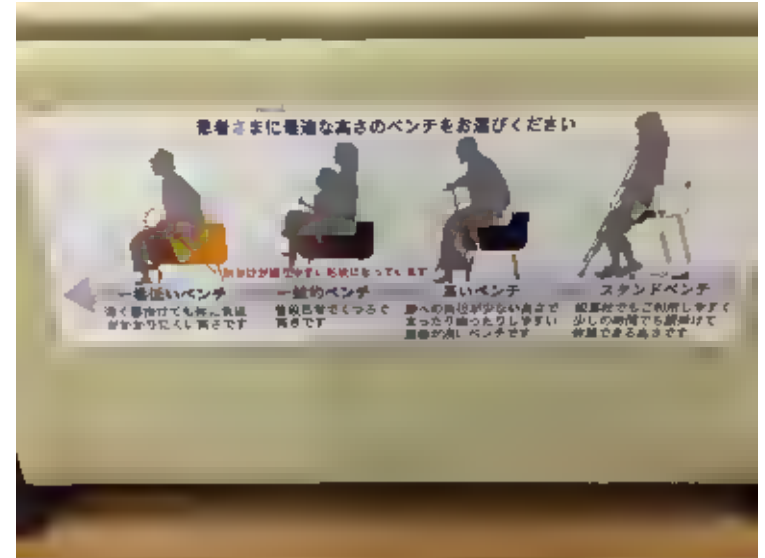

野餐桌輪椅位



輪椅能靠近使用



休息沙發床椅



日照中心午休躺椅



輪椅可及櫃台檯面

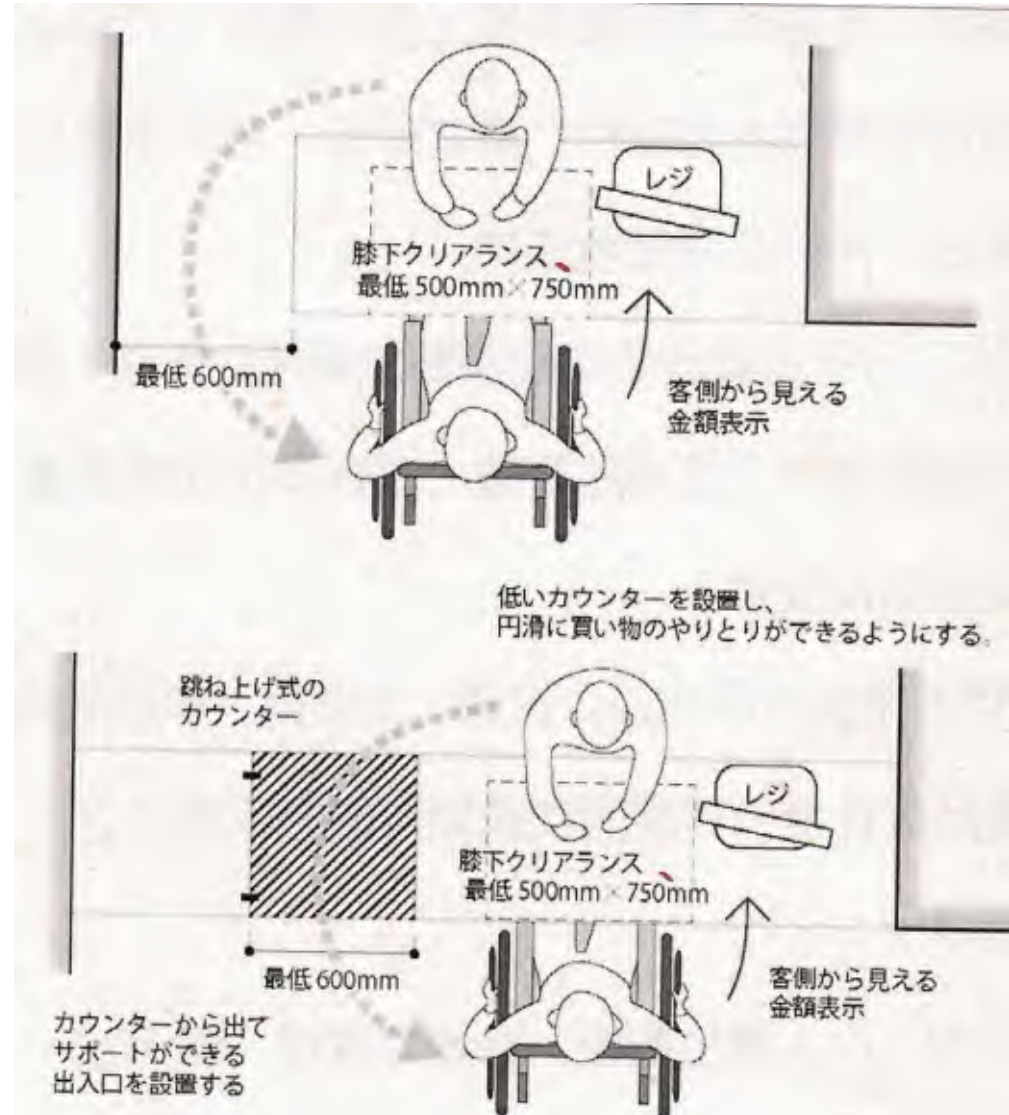

視障者家具



銳角包覆

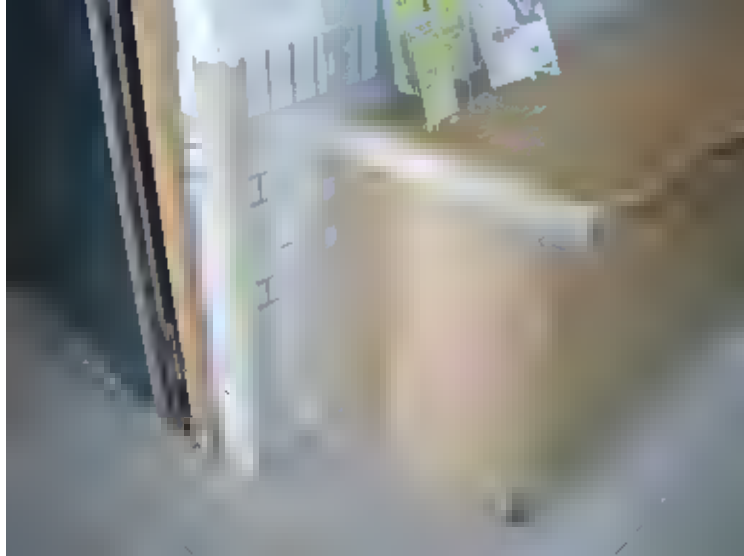

圓滑處理的桌面

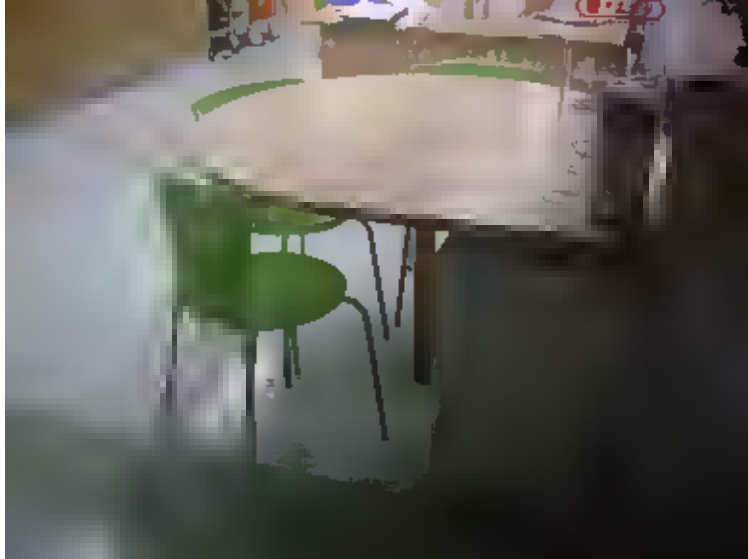

輔助設備

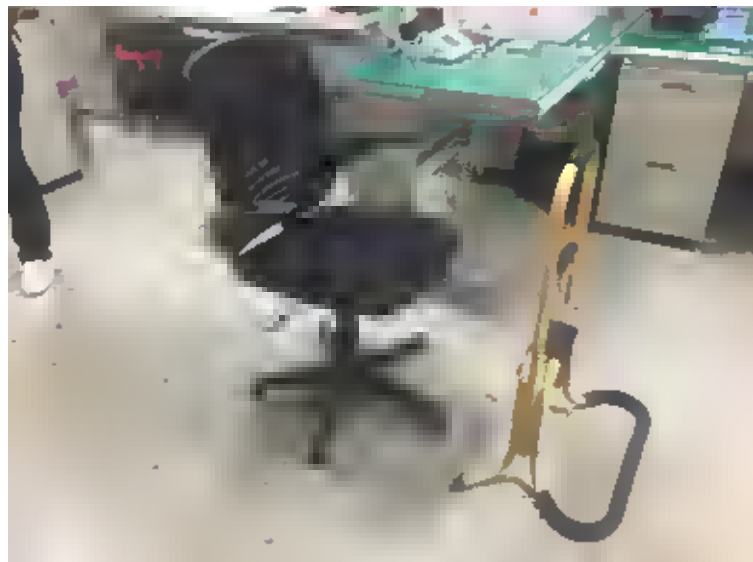
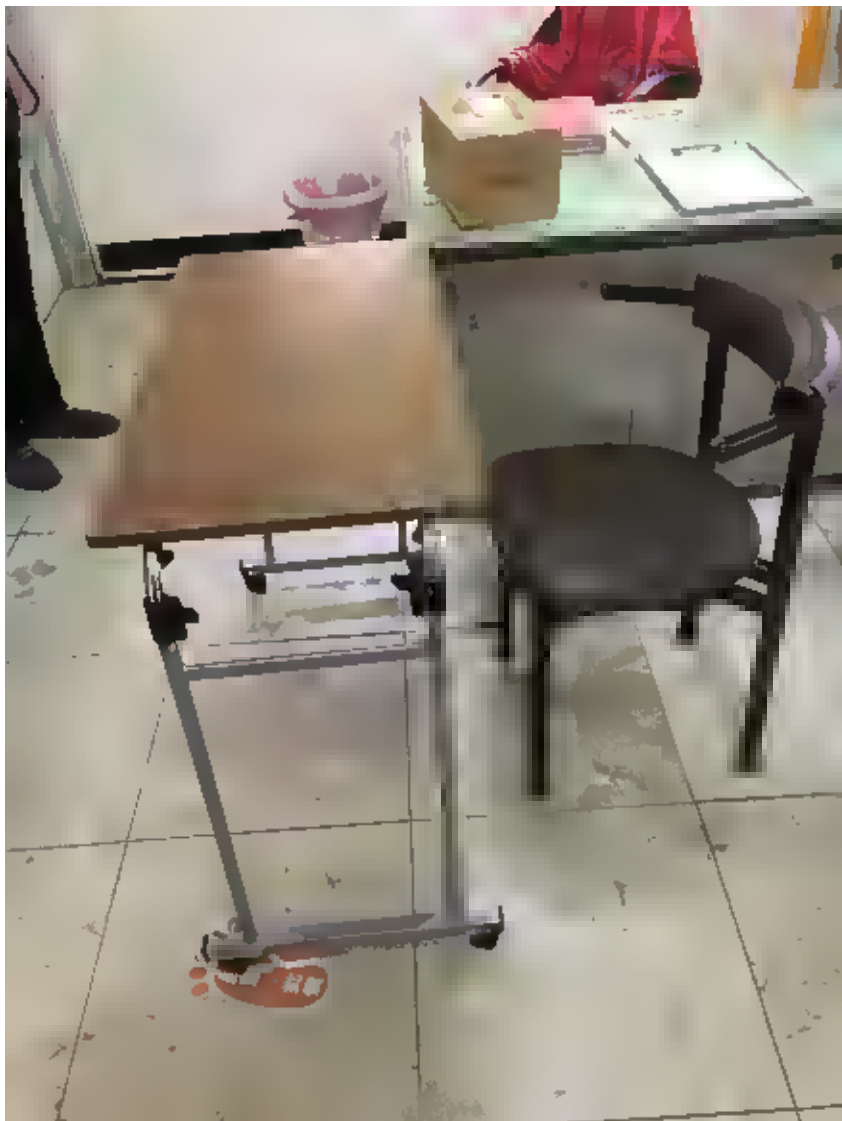

寢室書桌椅(可迴轉椅墊)



老人住宅之分類

- 1986年，國際慈善機構（HTA）制定老年人居住建築的分類標準：
 - A類**：非老年專用或用作富有活力的退休和退休前老人居住的住宅。有生活自理能力，可獨立生活的寓所。如：(個人住所)
 - B類**：提供富有活力，基本生活自理，僅需要某種程度監護和少許幫助的健康老人居住的住宅。如：(個人住所)
 - C類**：專為健康富有活力的老人建造的住所，幫助老人基本獨立生活的設施，提供全天監護和最低限度的服務和公用設施。如：(長青公寓、退休社區)
 - D類**：專為體力衰弱但智力健全的老人所建造的住所。入住者不需要醫院護理，但可能偶然需要個人生活的幫助和照料、監護和膳食供應。如：(安養之家、仁愛之家、榮民之家)
 - E類**：專為體力尚健而智力衰退的老年人所建的住所。可能需要某些個人生活的監護和照料。公用設施同d類，但可按需另增護理人員。如：(失智老人之家、榮民之家、安養中心)
 - F類**：專為體力和智力都已經衰退，並需要個人監護的老人所設。入住者很多人生活不能自理，因而住所不可能是獨立的，提供入住者進餐、助浴、清潔和穿衣等服務。此類建築物如：(個人照顧之家、療養機構、養護之家)
 - G類**：入住者除同f類外，還有患病、受傷的，臨時或永久的病人，這類建築中所提供醫療和護理的應是註冊醫護機構，住房幾乎全部應為單床間。如：(療養機構、養護之家)

老人住宅環境



伊利諾州退休軍人療養院



養老之家在眼前

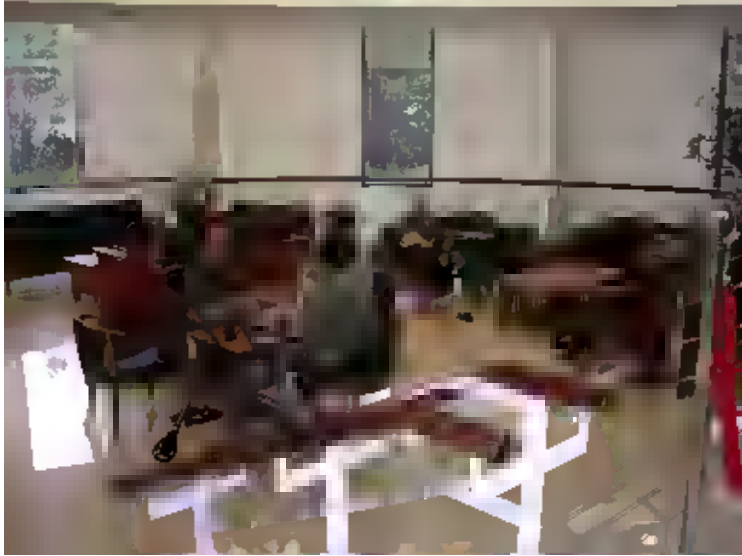

走廊扶手



走廊扶手

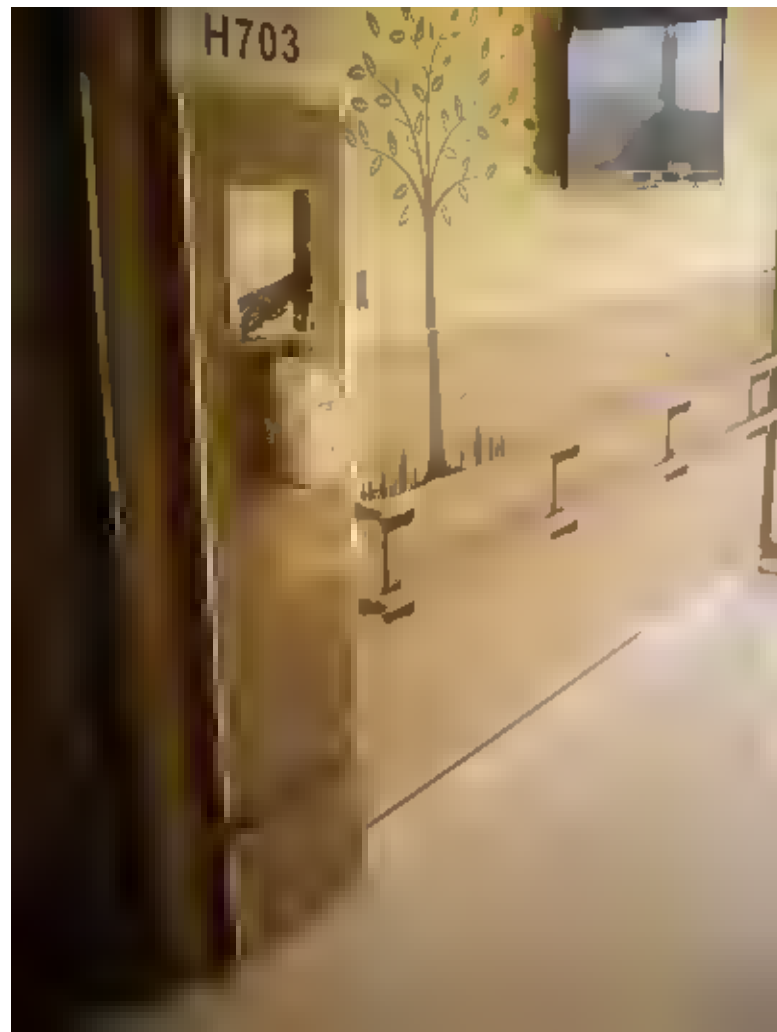

老人之家一

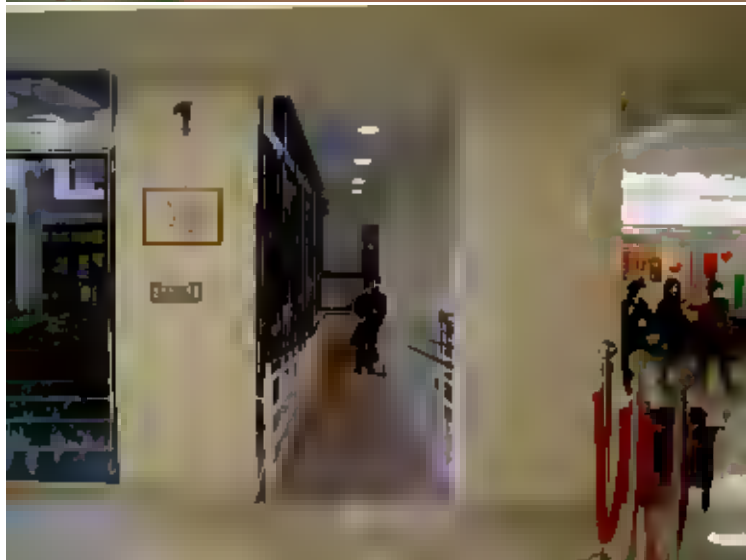

老人之家二



老人之家三



老人之家四

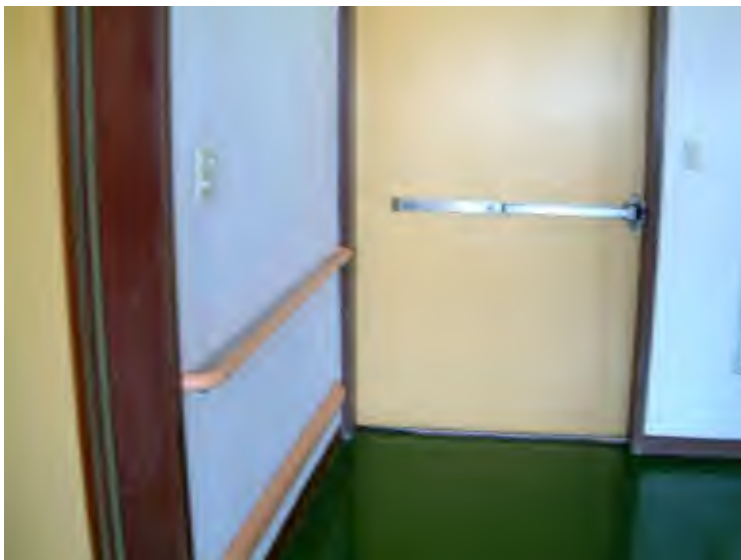

老人之家五



美國老人住宅



老奶奶的嗜好



深深的回憶或期盼



阿嬤的輪椅



日本老人住宅

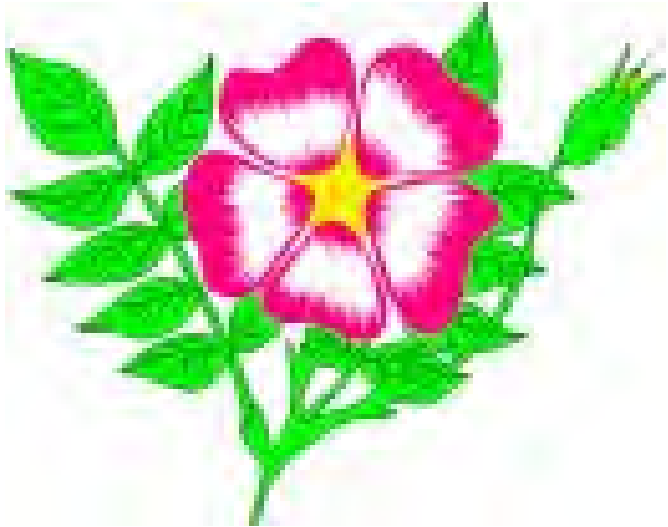

日本老人住宅

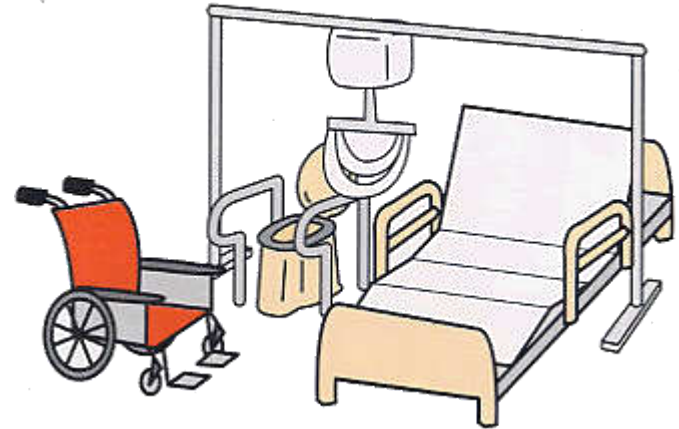

日本老人住宅環境



日本老人住宅



日本老人住宅



日本老人介護住宅



日本老人住宅



日本老人住宅臥室

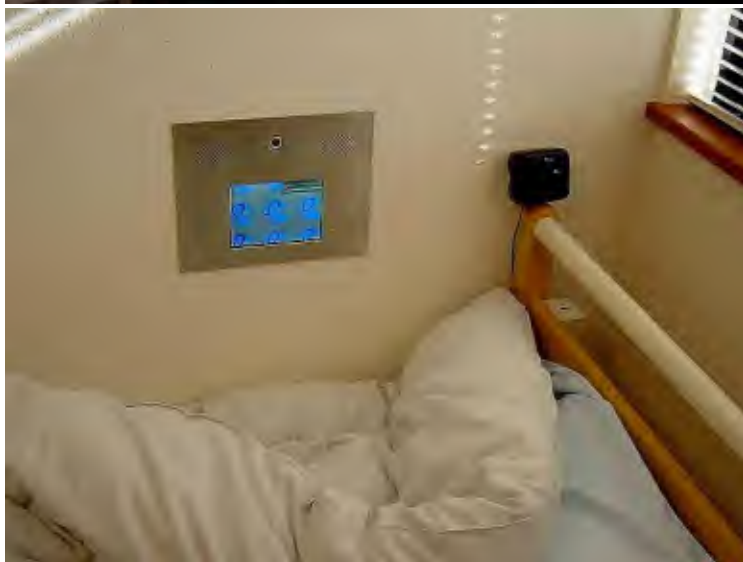

輕便開啟推轉拉門

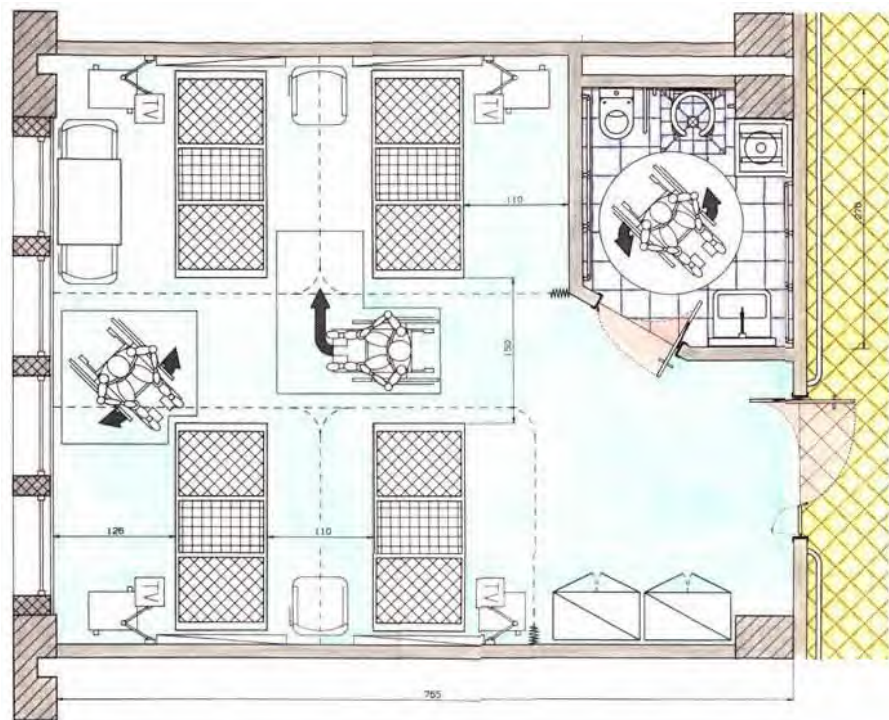
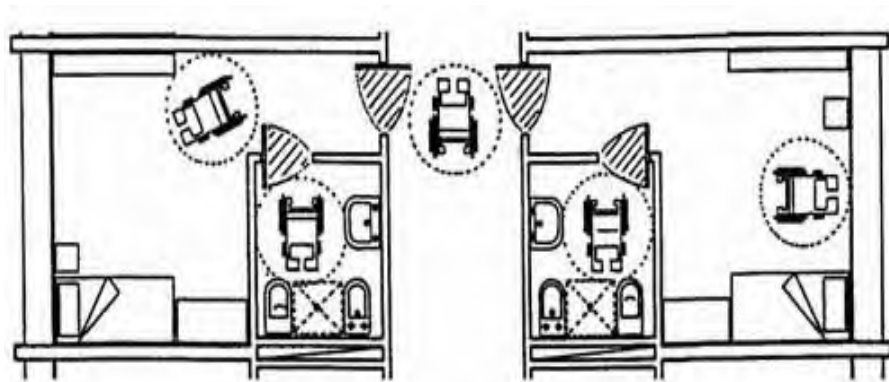

改修前後平面

改修後平面図

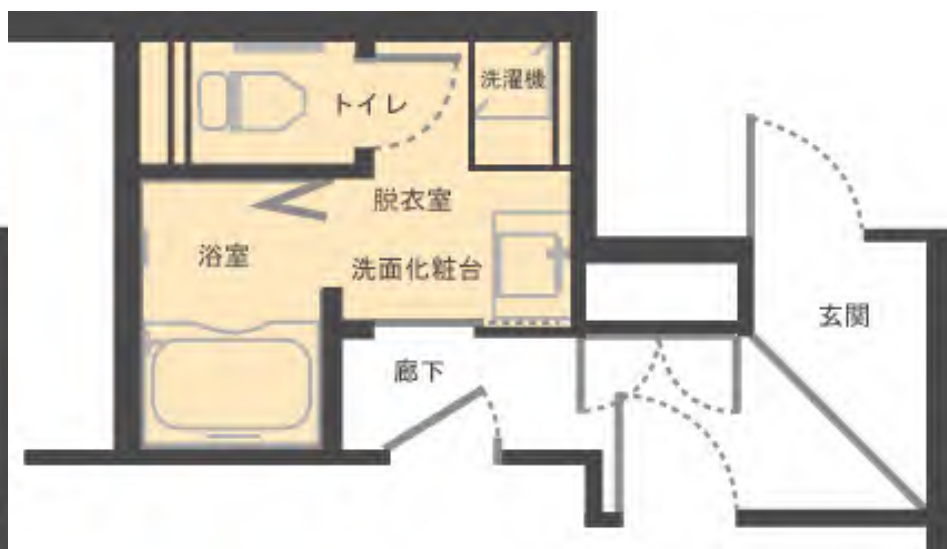
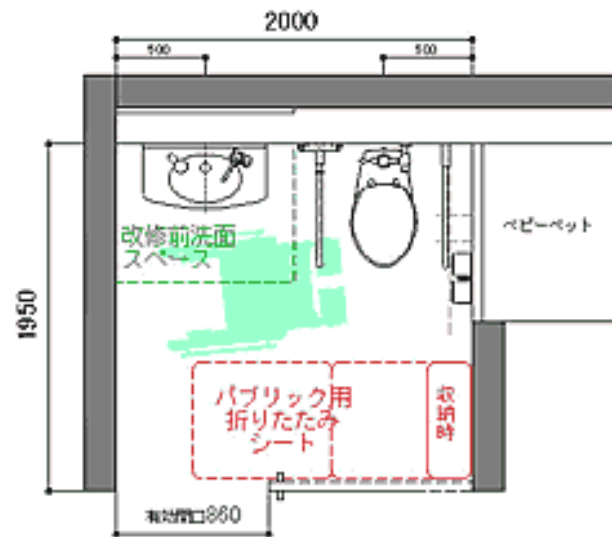
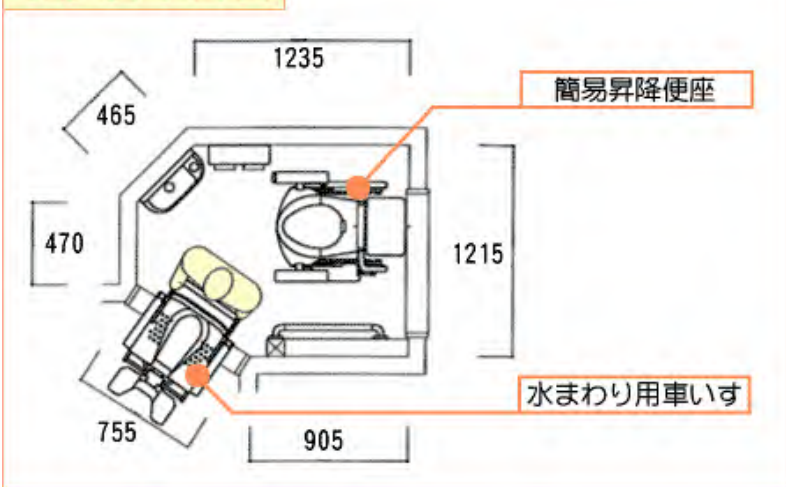

日本老人住宅



日本老人住宅



日本老人住宅



通用住宅内部



通用住宅內部

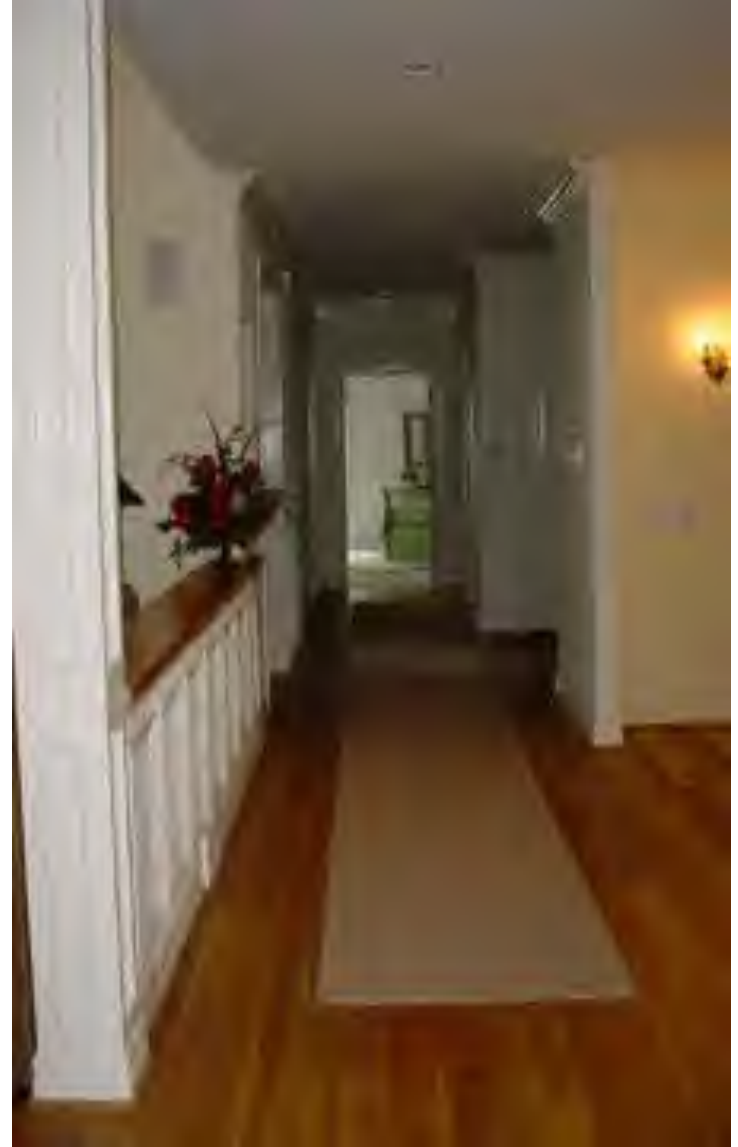

休閒、交誼

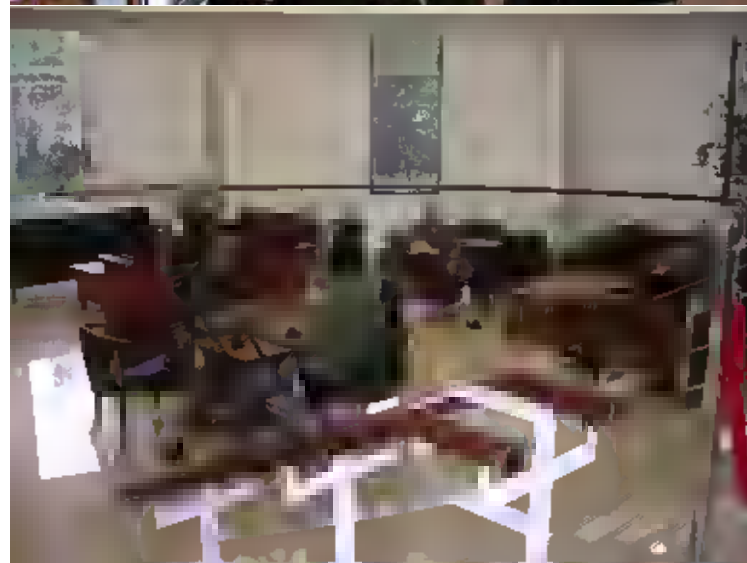

通用住宅内部



通用住宅內部

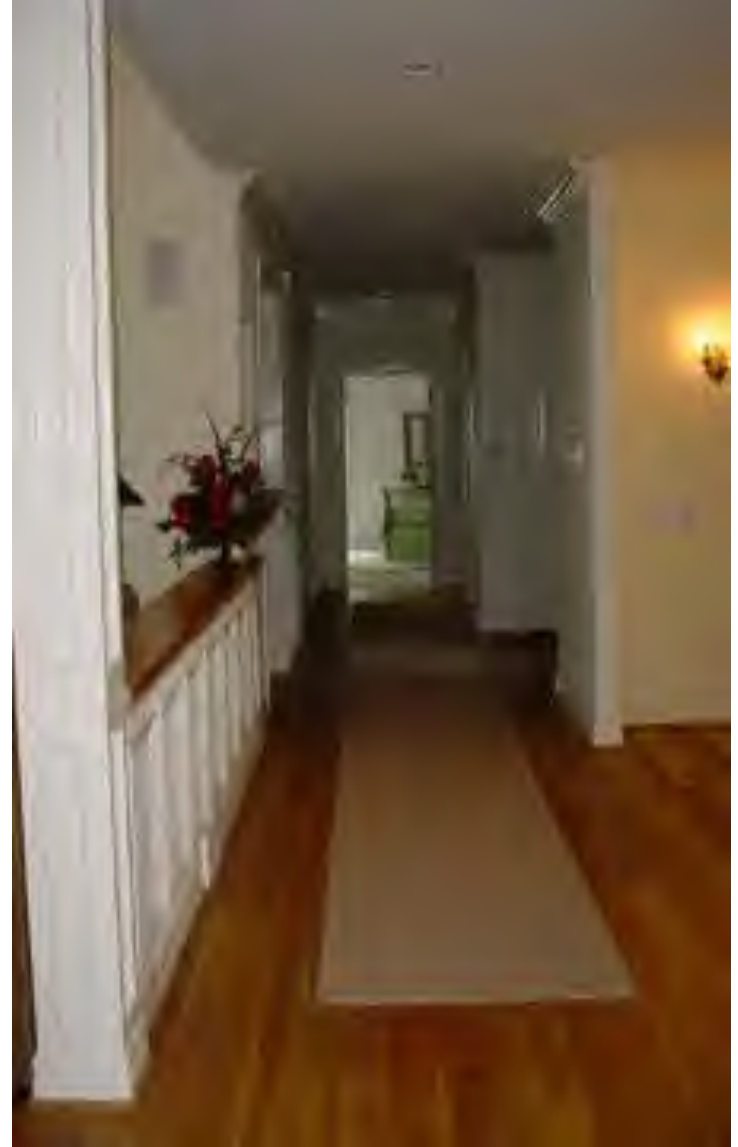

生活無障礙



臥室應考慮隔音、容易避難及輪椅使用
空間。

居住單元/雙人床

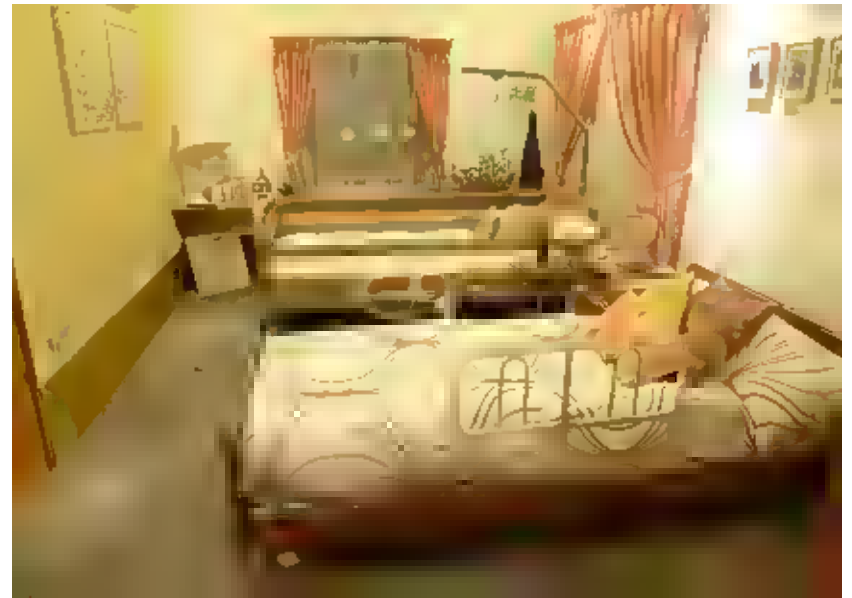
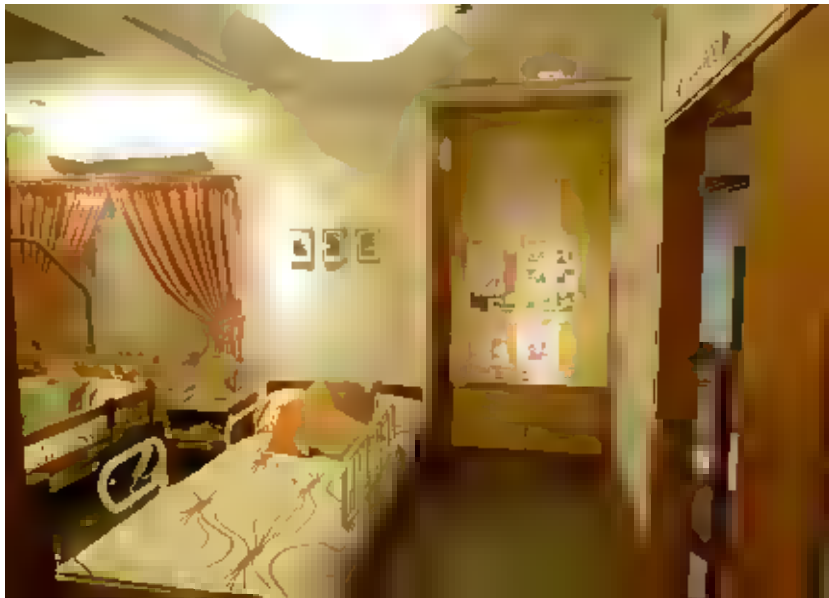

臥室之床位擺設可二面上下床



臥室之床位擺設可二面上下床



室內廁所配備



室內空間安排

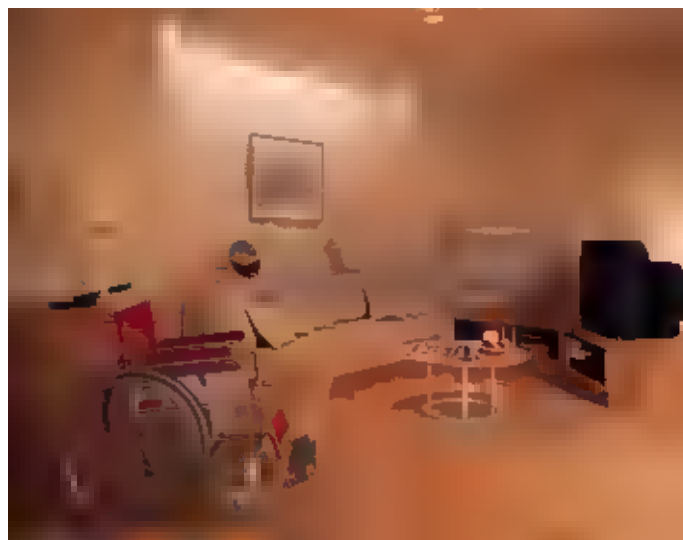
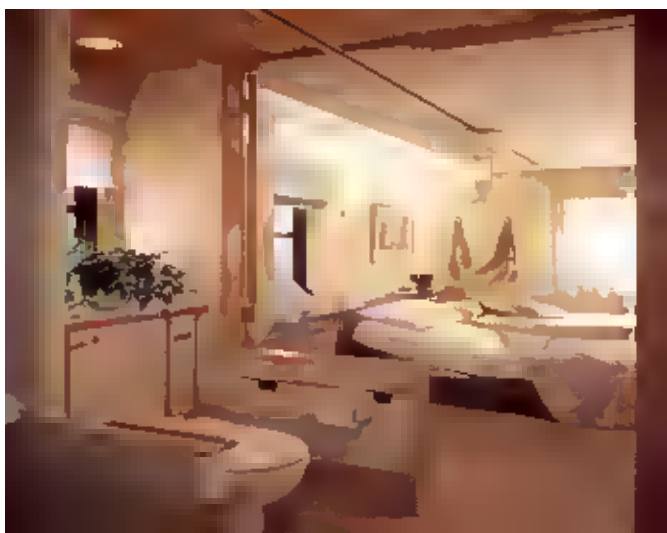

防撞護邊



銀髮族用品



餐廳桌椅、用餐具等特色



陽台採光

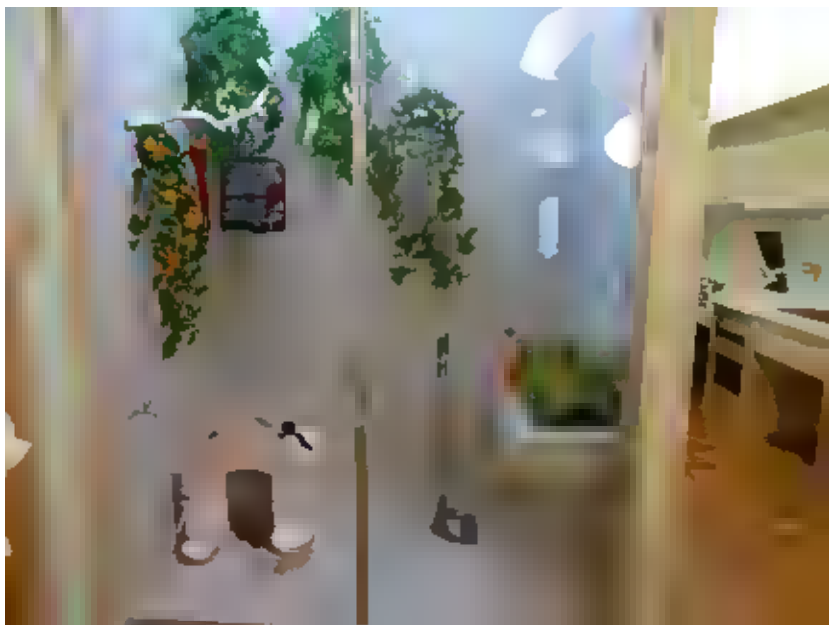

增設坡道



各型廁間尺寸A

活動範圍範例：

空間尺寸 1300mm×2000mm/ 下圖 a 馬桶前方空間（深度）700mm 左右

■ 手動輪椅（小型洗手間）直角接近時

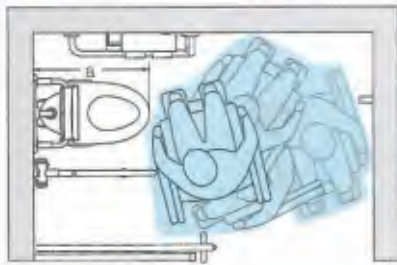

■ 電動輪椅由斜前方接近時

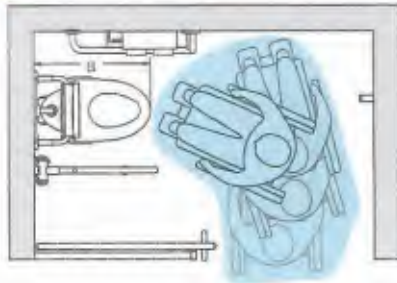

活動範圍範例：

空間尺寸 1500mm×1800mm/ 下圖 a 馬桶前方空間（深度）700mm 左右

■ 手動輪椅（小型洗手間）直角接近時

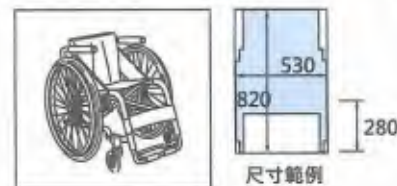
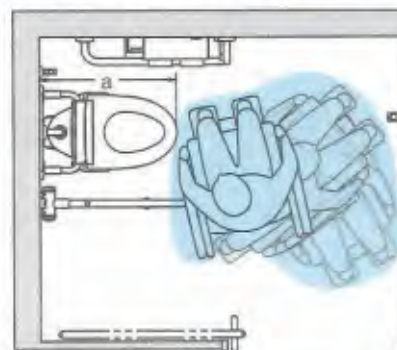

■ 電動輪椅從斜前方接近時

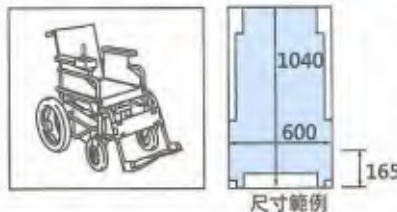
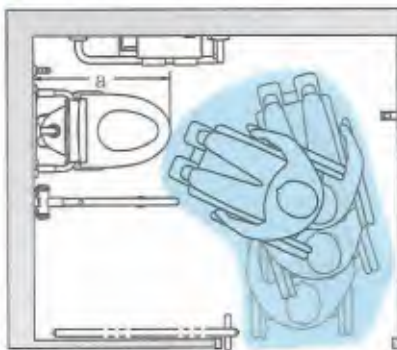

輪椅易於旋轉的空間

必要空間會因輪椅類型，和使用者的身體狀況而不同，一般說來，電動輪椅的尺寸比手動輪椅大，且後輪的旋轉軸位於後方，旋轉半徑亦較大。

活動範圍範例，空間尺寸 2000mm×2000mm/ 下圖 a 前述馬桶尺寸（深度）700mm 左右

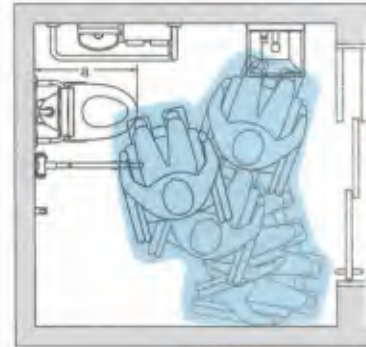

■ 手動輪椅（小型）活動範例

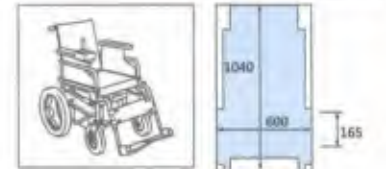
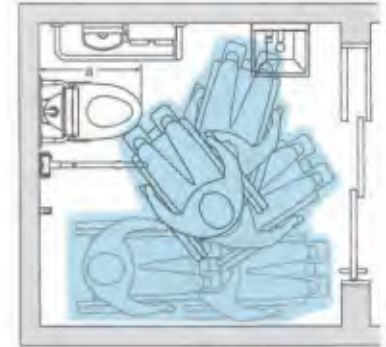

■ 電動輪椅在前方活動範例
（前方馬桶前方活動空間，2000mm×2000mm）

設置馬浴器具時的考量重點

設置嬰幼兒同行者所需器具，以及醫療床等浴浴器具時，不可妨礙輪椅移動的動線和出入通行，必要時，可增大洗手間的使用空間。

■ 內設障礙物無障礙設計規範

廁所盥洗空間內應設置足夠空間，其寬度不得小於 1200mm。

1 醫療床設置範例

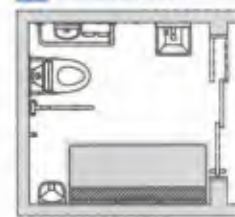

■ 醫療床設置範例（標準型醫療床）

2 嬰幼兒同行者所需器具設置範例

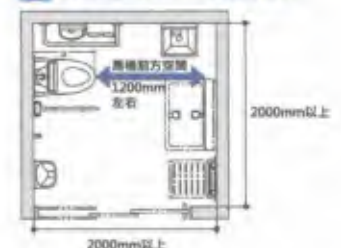

各型廁間尺寸B

○ 無障礙洗手間 (小型方案) 一般洗手間 (考慮輪椅使用者需求的洗手間)

讓有各式輪椅的使用者，能在洗手間內可迴轉的最高限度空間。

確保「馬桶前方空間」，讓使用者能接近馬桶、迴轉等，在洗手間內活動。具體「馬桶前方空間」的必要空間如下。

1 馬桶前方空間 (深度) 達 1200mm 以上時

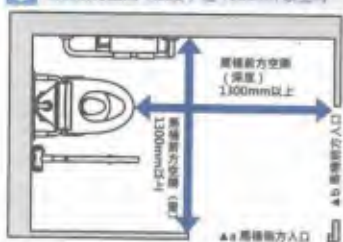

- ① 確保深度 1300mm 以上
寬 1300mm 以上 × 深 1500mm 以上
- ② 無法確保深度 1300mm 以上
寬 1500mm 以上 × 深 1100mm 以上

■ 上述 ① ② 的馬桶前方必要空間，不論出口位置在馬桶側面 (下圖 a)，馬桶前方 (下圖 b)，都是一樣的。

2 馬桶前方空間 (深度) 未達 1300mm 以上時

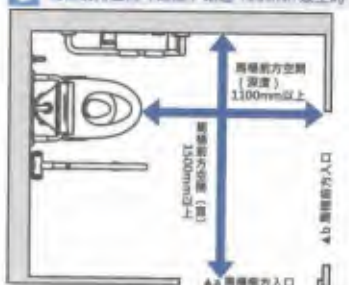

開關門的空間

保留輪椅迴轉的空間，以便使用者能順利開、關門和上鎖。

活動範圍範例：
空間尺寸 1300mm × 2000mm (馬桶深度 700mm 左右) 時

馬桶前方入口，設置外開式門時

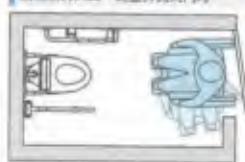

▶ 成人尺寸標準，輪椅尺寸，門開門，上鎖

馬桶側面入口，設置拉門時

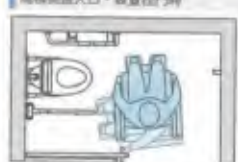

▶ 成人尺寸標準，輪椅尺寸，拉門，上鎖

靠近馬桶的空間

雖然和「無障礙洗手間 (標準方案)」(P.26、27) 相比，靠近馬桶上受到較多的限制，但保留了輪椅使用者，能在洗手間內自行 (不需他人照護) 靠近馬桶 (斜前方、直角) 的空間。

■ 輪椅使用者靠近馬桶的距離 (P.25、27) 正面、斜前方、直角、45度角中，尤以①正面才能通過兩個方向，在輪椅尺寸較大時，可能會與坐便器發生碰撞。

活動範圍範例：
空間尺寸 1500mm × 1800mm (馬桶深度 700mm 左右) 時

由斜前方接近馬桶時

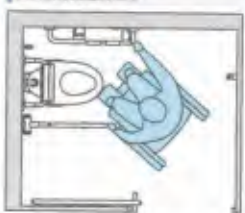

▶ 除了確保馬桶與馬桶前方距離外，還必須確保馬桶與馬桶前方距離的足夠空間，以及馬桶前方的空間。

由直角接近馬桶時

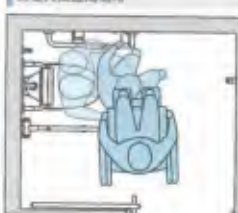

▶ 確保馬桶前方，只留下必要空間，以確保馬桶前方，馬桶前方距離的足夠空間，以及馬桶前方的空間。

設置扶手，以維持使用者起身、坐下時的姿勢平衡。

馬桶用扶手，對於輔助輪椅使用者、拐杖使用者等行走者，由馬桶上起身或坐下、移至馬桶、維持姿勢平衡、穿脫衣物等，是非常重要且能發揮作用的設備。

充分考量使用者各種身體狀況和動作特性後，再決定扶手的種類和設置位置。

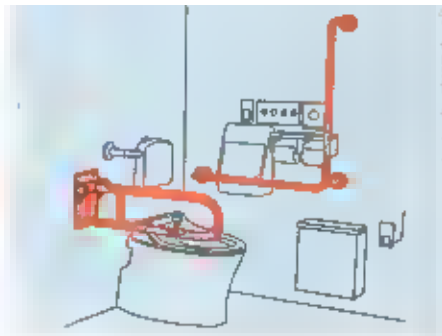

設置位置

垂直部分：馬桶前緣 + 200mm ~ 300mm 左右
設置在能輔助使用者起身、坐下的位置。

水平部分：馬桶前緣 + 250 ~ 270mm 左右
設置在能輔助使用者容易移至馬桶上，以及坐在馬桶上時，能輕鬆擺放手肘的位置。

- 內政省標準物用規格規範
 - 扶手水平部分垂直長度不得小於 700mm
 - 垂直部分扶手外緣與馬桶前緣距離 270mm
 - 水平部分扶手外緣與馬桶前緣距離 270mm

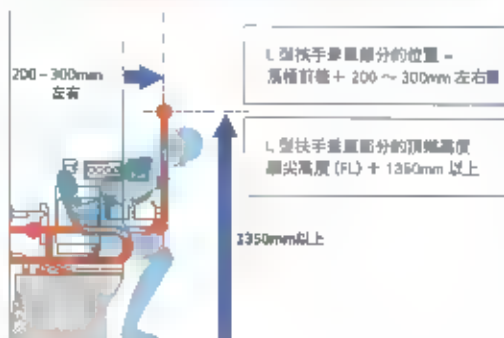

和馬桶之間的距離 (寬度方向)
= 左右兩側扶手距離馬桶中心
距 350mm 左右

扶手水平面高度
= 左右兩側扶手為便座平面 +
250 ~ 270mm 左右

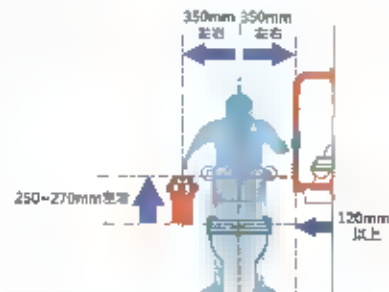

各型廁間尺寸C

CHUCK

為了方便更換尿布和穿脫衣服，而設置照顧床。

為了讓能自立的輪椅使用者自行導尿，以及照護者輔助輪椅使用者更換尿布、穿脫衣服等，必須讓成人橫躺下來。無障礙洗手間內設置照顧床，將有助於障礙者和高齡者外出活動。另外，照顧床也可以利用在更換嬰幼兒尿布。非常便利。設置在預設使用者為嬰幼兒同行者的場所內時，建議同一空間內加設嬰兒椅。

注意 請務必在便所者容易看到處，貼上此章品附的「警手標識」。

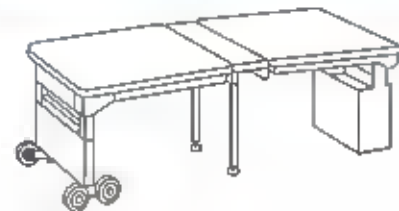
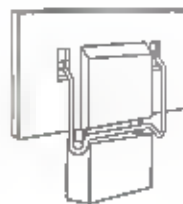
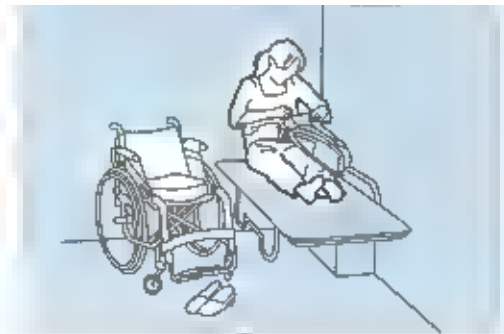

設置上的注意事項 (多功能洗手間)

▶ 無障礙廁所 (公共用) 修改

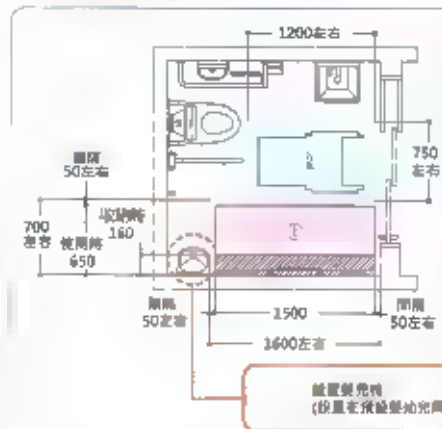

▶ 無障礙廁所 (公共用) 修改

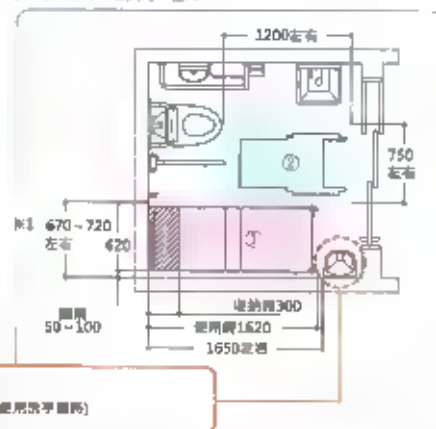

必要的設置空間

- 1 照顧床本體設置空間寬 700mm × 長 1600mm
- 2 使用照顧床，並確保輪椅的空間寬 750mm × 長 1200mm

必要的設置空間

- 1 無障礙本體設置空間寬 670 ~ 720mm × 長 1650mm
 - 裝設握把型照顧床時，和牆壁面相對的間隔請保留 100mm (此時 1 的空間寬度必須達 720mm)
 - 2 使用照顧床，並將輪椅停在旁邊的空間寬 750mm × 長 1200mm
- 考量安全性，避免設置在長邊兩側皆無牆壁之場所
請設置在長邊單側有牆壁。

馬桶寬度約45cm、
深度約72cm。

輪椅族如廁過程



1 就座馬桶前先將隨身行李掛在牆上。

+

在不妨進行動的位置 設置可掛行李的掛勾。



2 垂直接近 (坐姿移位)

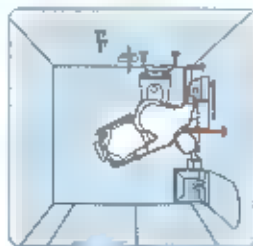

輪椅推至馬桶垂直的位置，手握輪椅或扶手並用體的力量滑動至馬桶。

+

應確保馬桶側方有足夠的空間讓輪椅易於靠近，須接連兩層垂直距離的扶手，避免移動時撞碰到牆壁。

依不同需求的使用者，可分為由馬桶側方、斜前方、前方，扶著輪椅或扶手由輪椅移動至馬桶。

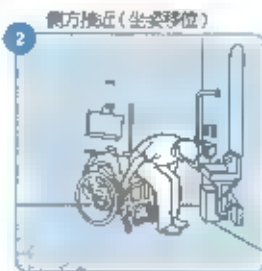

2 側方接近 (坐姿移位)

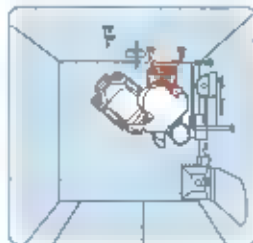

輪椅推至馬桶側方的位置，手握輪椅或扶手、馬桶，並用體的力量滑動至馬桶。

+

應確保馬桶側方有足夠空間讓輪椅易於靠近。

手(指)觸污時



4 坐在馬桶上洗手 (指)

因為有需要坐著才能洗手的使用者，故洗手盤需安裝在馬桶的側方。



3 正面接近 (站姿移位)



由馬桶正面接近，以扶手輔助就座。

+

應確保馬桶前方有足夠的空間讓輪椅易於接近。



5 不費力的姿勢就可以輕鬆的洗手。

+

應保證盆下方的空間，讓輪椅可以接近臉盆。



3 斜前方接近 (站姿移位)

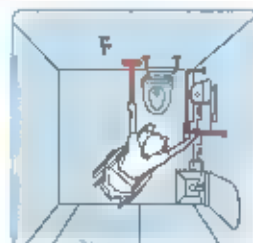

由馬桶斜前方接近，以扶手輔助起身並就座。

+

應確保馬桶前方及側方有足夠的空間讓輪椅易於接近。

輪椅導尿使用馬桶或小便器

開門

進入洗手間

關門上鎖

走近馬桶

取出輔具

1 準備如廁

如廁



取出輔具(導尿管),準備如廁。

+ CHECK

將輔具的盒子放在平台或掛在掛鉤上

2 清潔

沖洗馬桶

洗手

擦手

開門

離開洗手間

關門

2



如廁後將輔具(導尿管)放回盒子裡。

廁間門標示應可觸摸

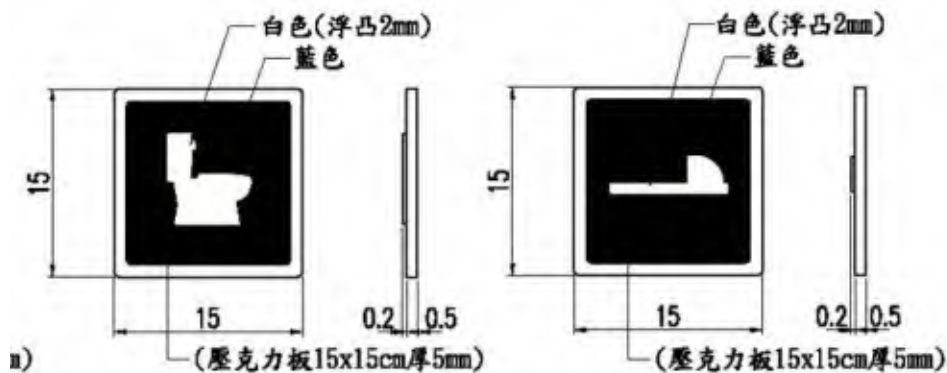

廁所標誌(座式便器)

廁所標誌(蹲式便器)

UNIT=cm, S=N. T. S.

UNIT=cm, S=N. T. S.



觸摸分別馬桶樣式的標示牌

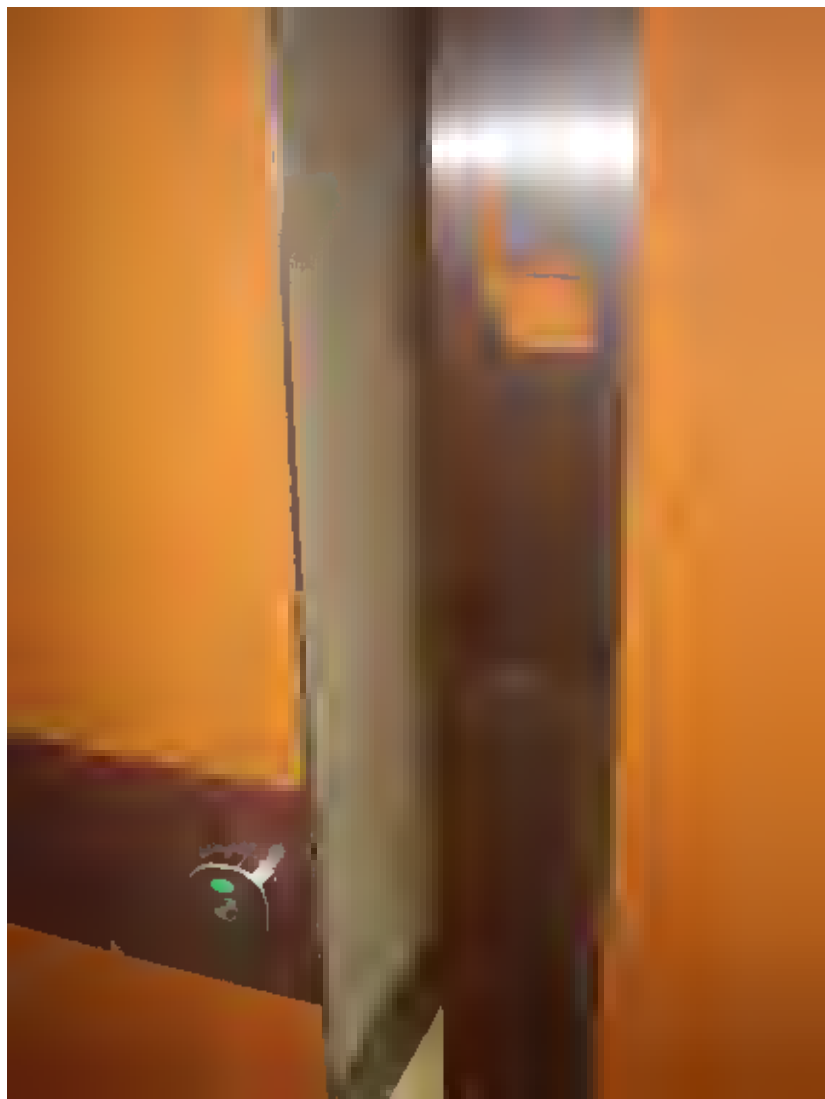

如廁動線 TOTO

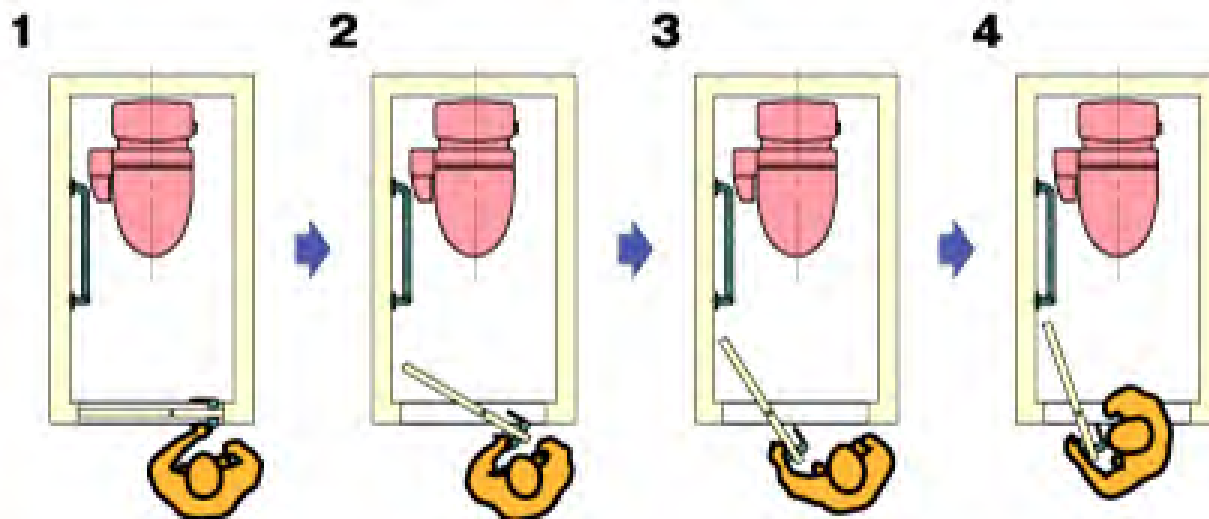

ドアを閉める

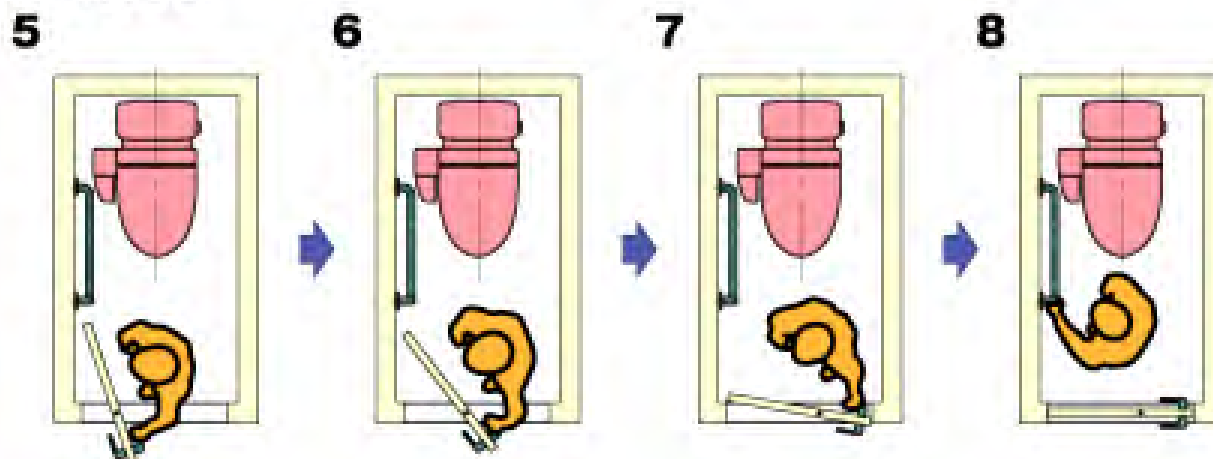

斜側移坐

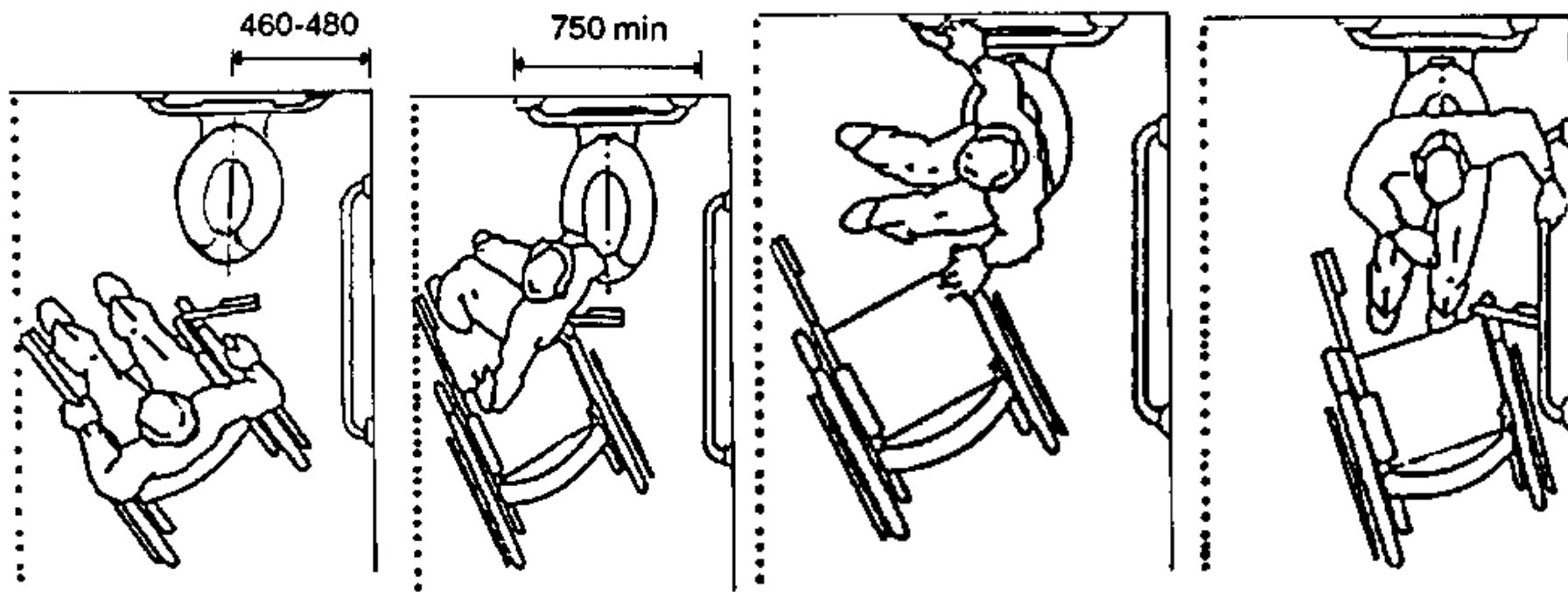

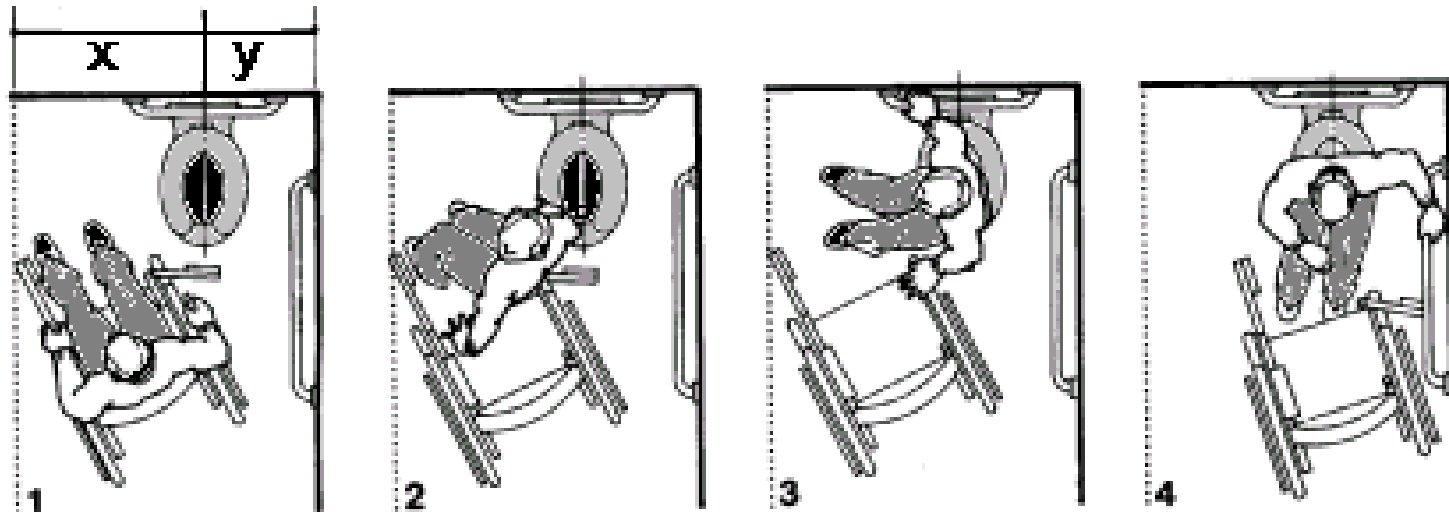

A

x:45-80cm

y:45cm

z:110cm

輪椅使用者與馬桶間的轉換關係

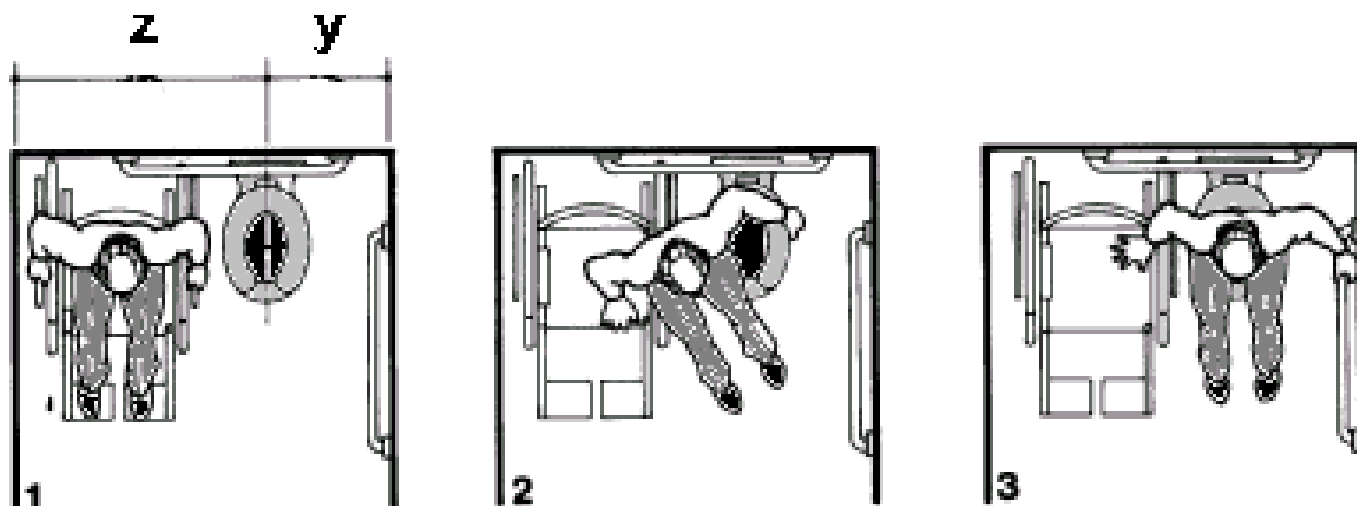

B

無障礙廁所

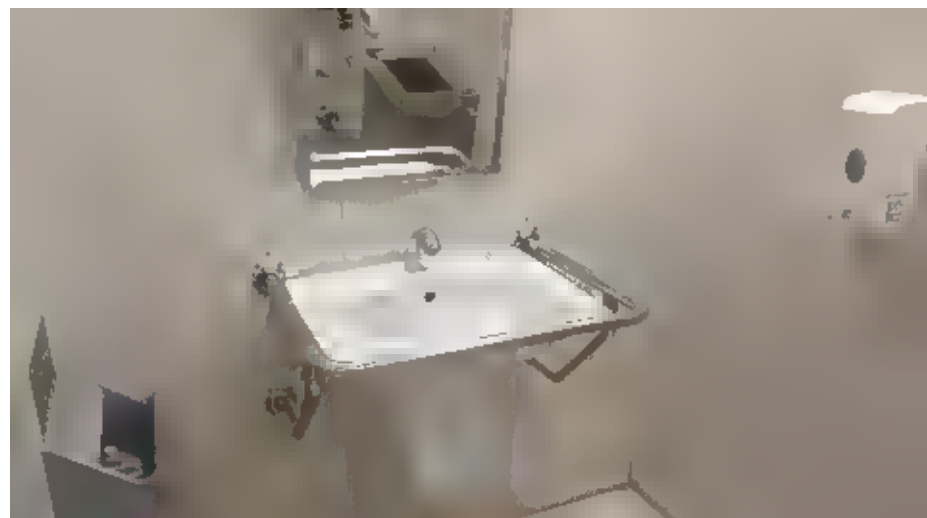
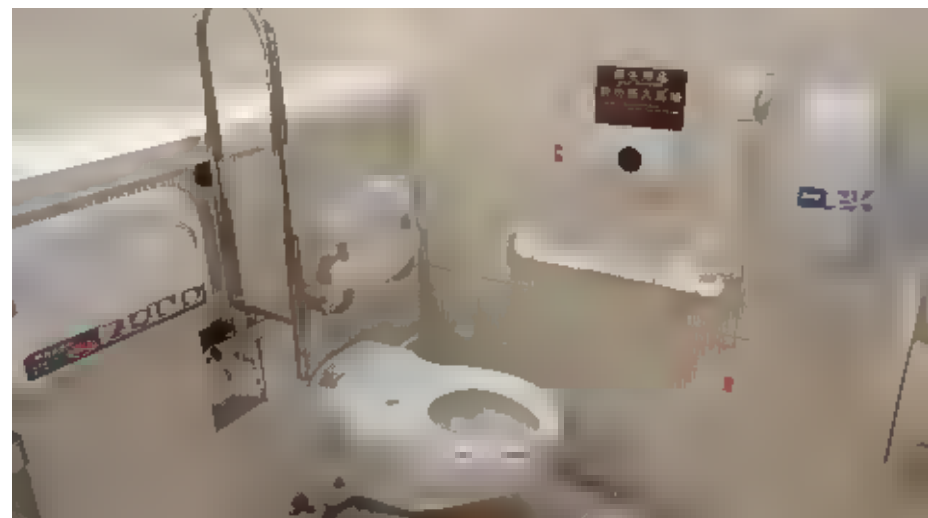
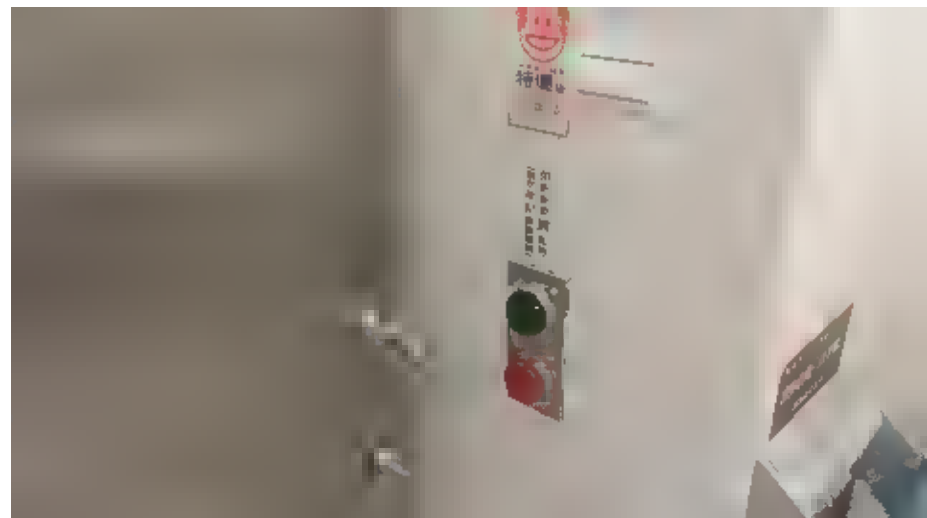
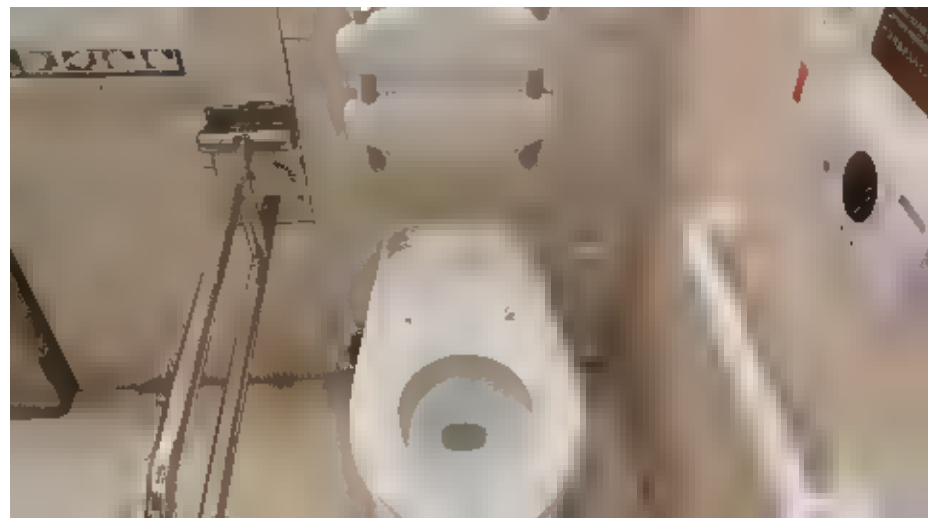

日本老人可用廁所

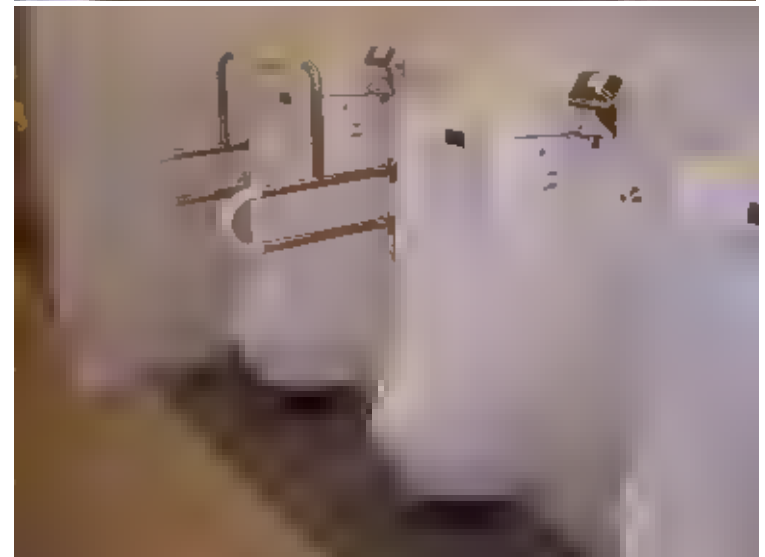
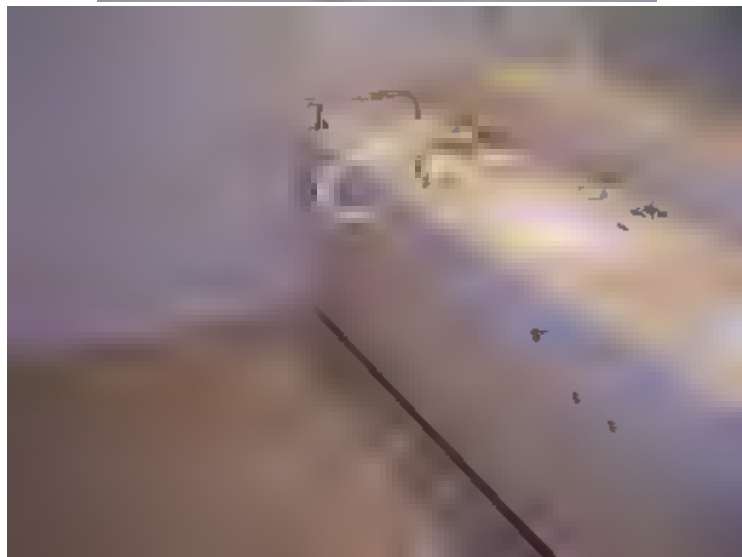

A405.11 照護床

《 参 考 図 》

【図8.12】 折り畳み式大型ベッドの例
(幼児～大人まで：折畳み収納型)

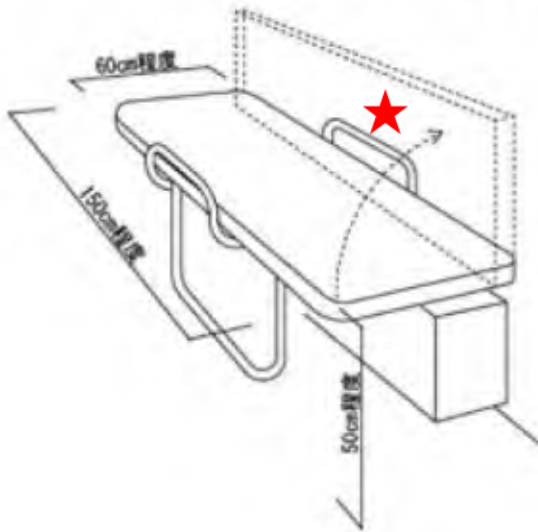

照護床



收納時



使用時



照護床 短邊靠牆

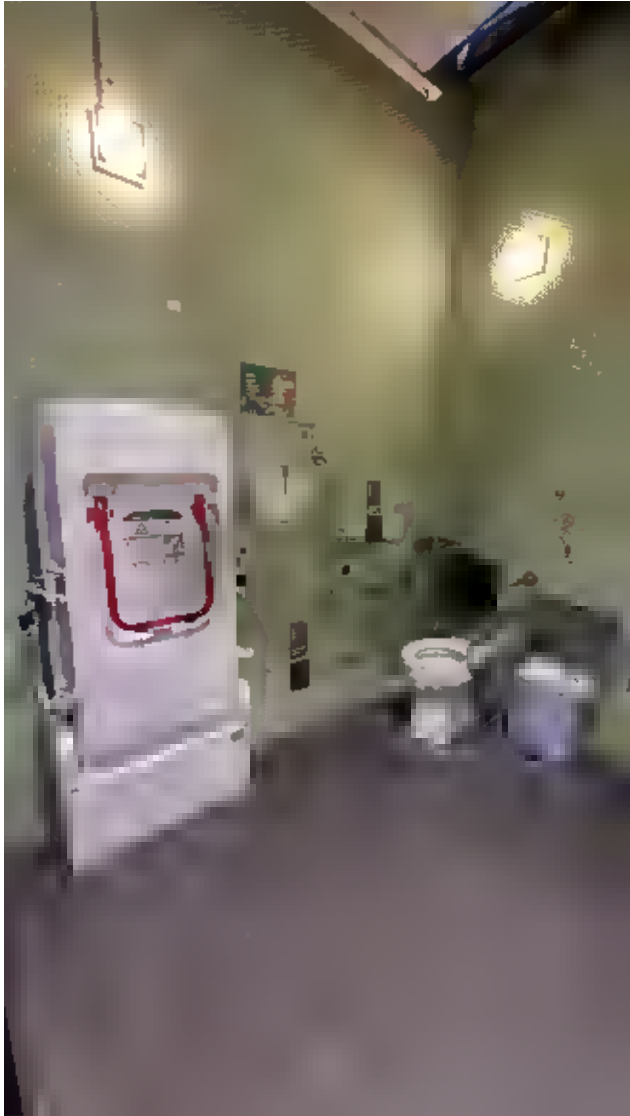

使用方法 長邊靠牆

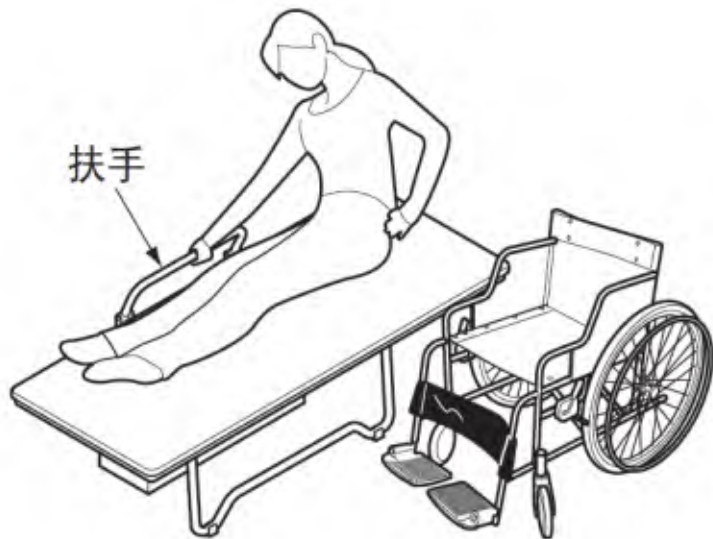
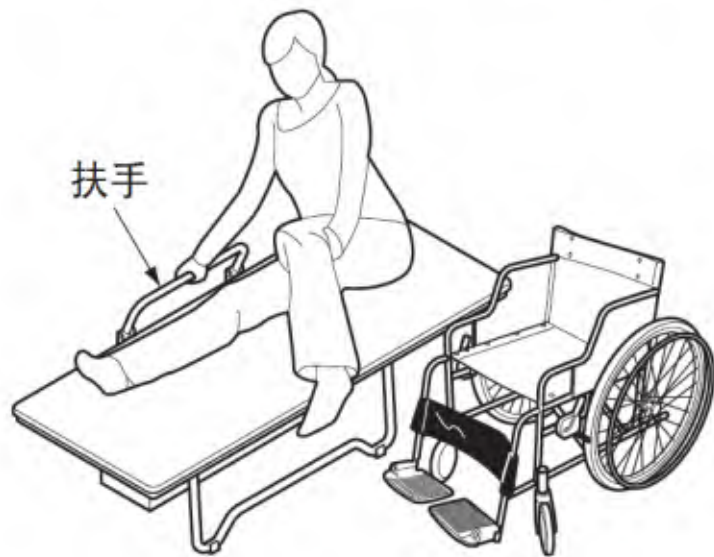

加設照護床的無障礙廁所

3-4. 廁所盥洗室

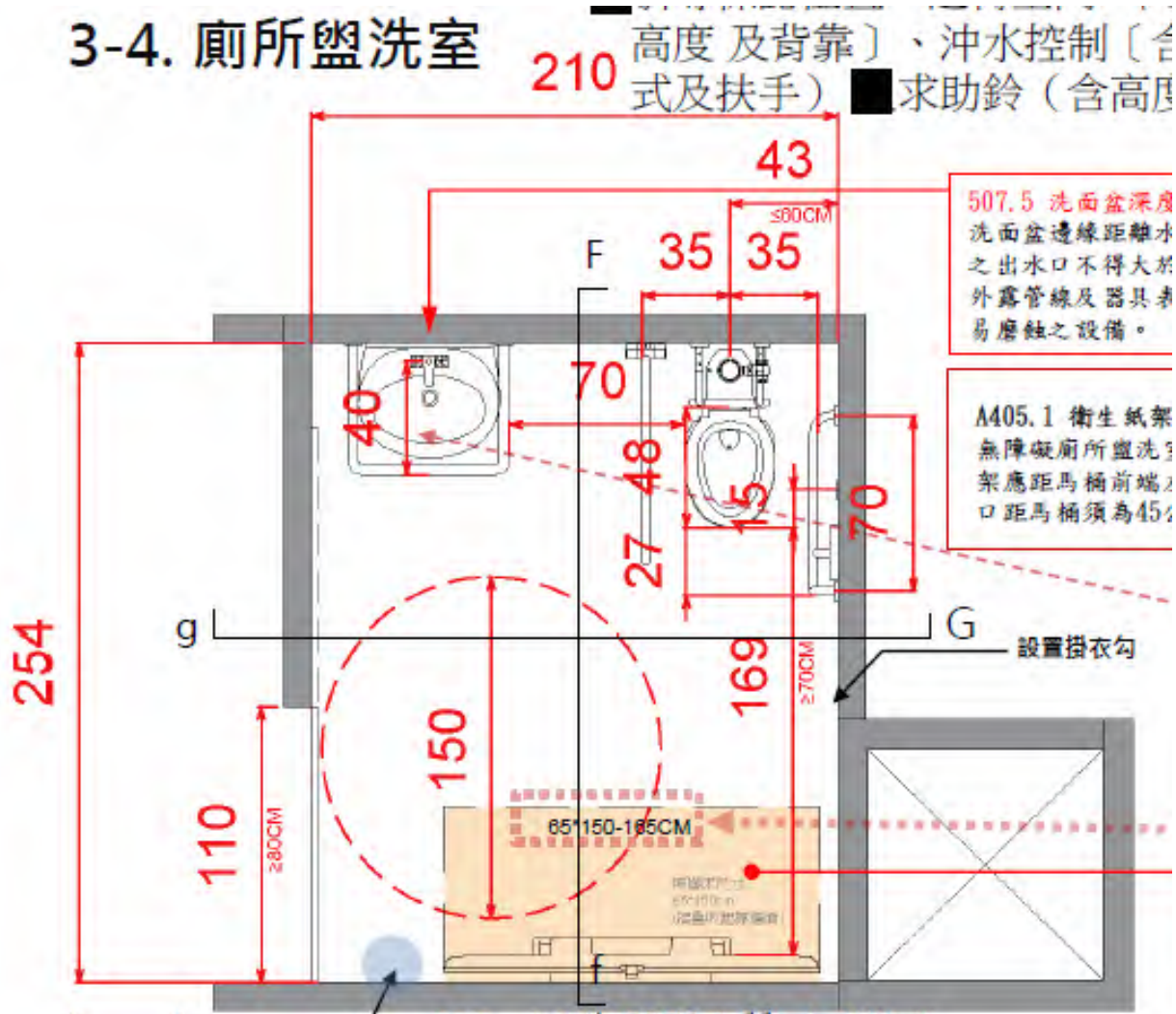

210

高度及背靠)、沖水控制〔合式及扶手〕 求助鈴 (含高度)

43

$\leq 80\text{CM}$

F

35

35

40

70

48

27

15

507.5 洗面盆深度
洗面盆邊緣距離水
之出水口不得大於
外露管線及器具表
易磨蝕之設備。

A405.1 衛生紙架
無障礙廁所盥洗
架應距馬桶前端
口距馬桶須為45

G 設置掛衣勾

254

g

110

$\geq 80\text{CM}$

150

169

$\geq 70\text{CM}$

85 150-165CM

障礙物
500mm
高度
100mm
高度

通用住宅内部



淺截水溝

廁所門口應設置截水溝來取代門檻，可方便行動不便者進出。



減少轉身造成暈眩

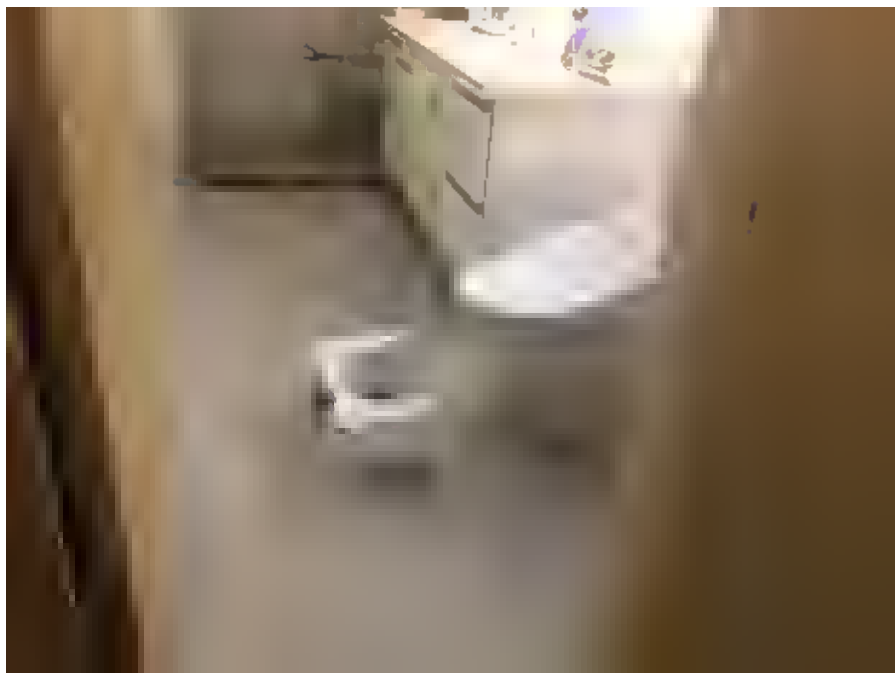

日本多功能廁間



淋浴間、截水溝^{UD}

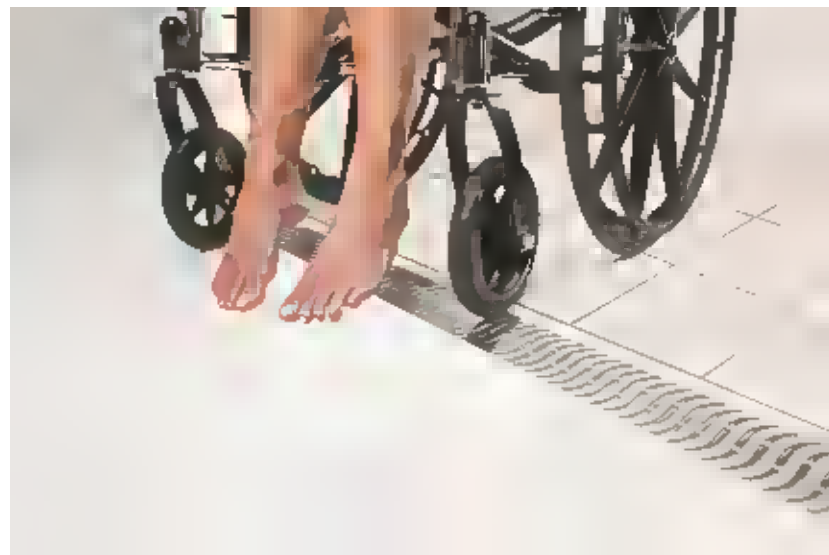

求助鈴 504.4 ; 505.6



圖505.6



一處在距離馬桶前緣往後15公分、馬桶座位上60公分，；另在距地板面高15~25cm範圍內設置一處可供跌倒後使用之求助鈴，且應明確標示，易於操控。

☐ 雙掀起式活動扶手扶手

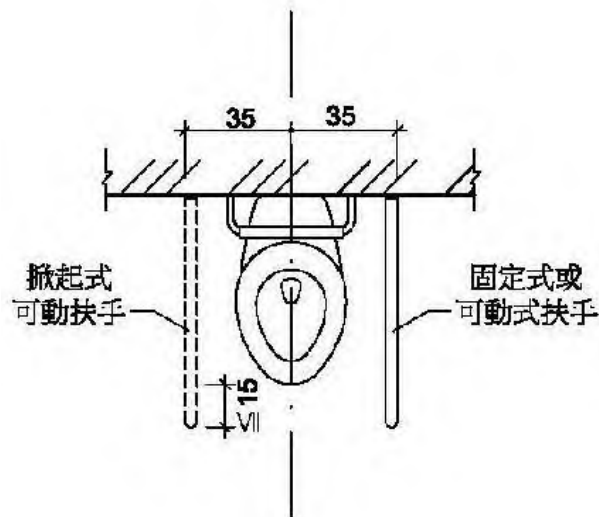
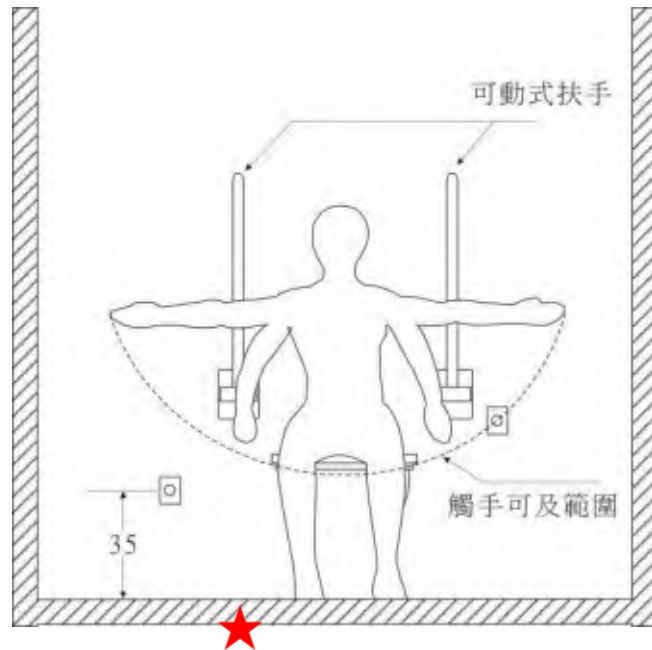
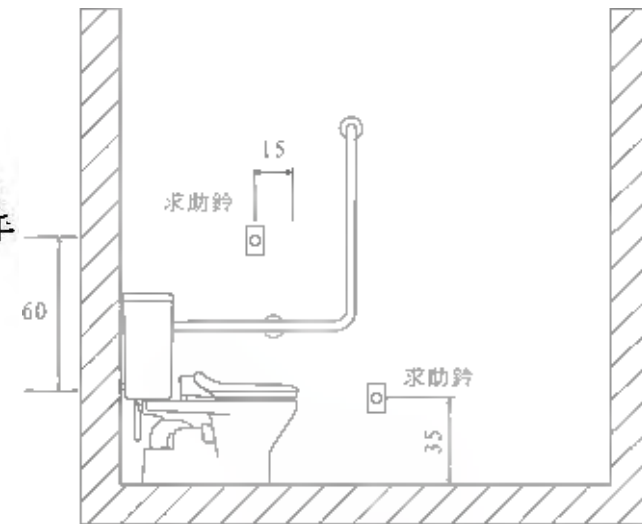
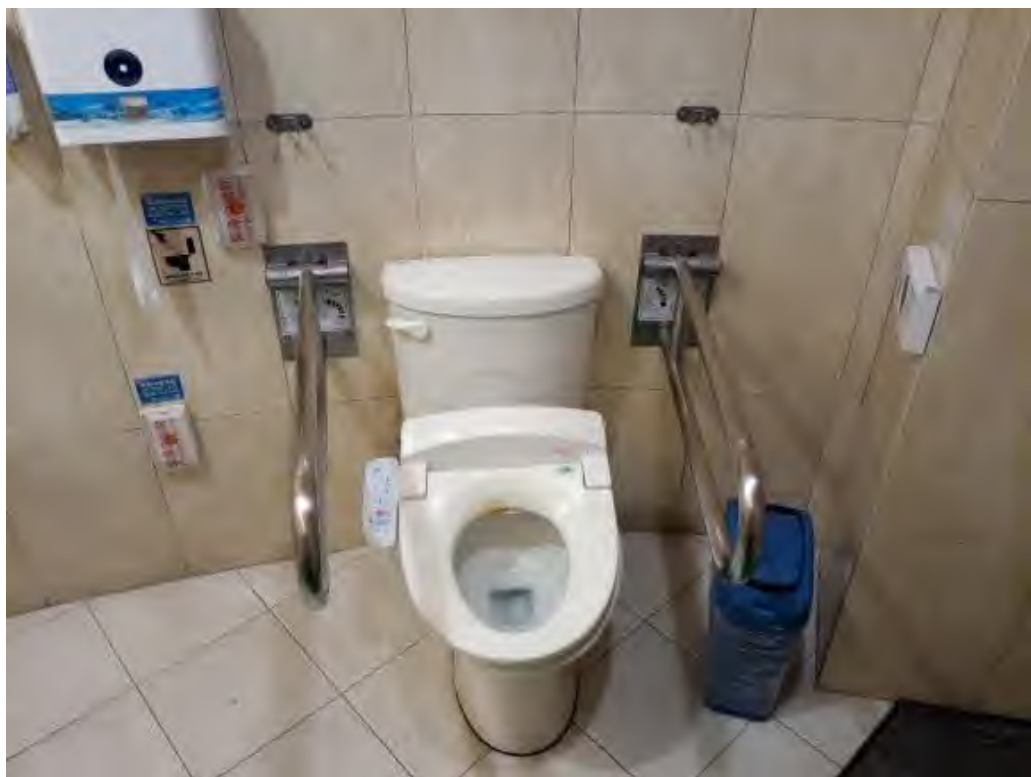

全木紋活動扶手

木紋&不銹鋼原色活動扶手



固定低水箱可當靠背墊



□轉角處支撐

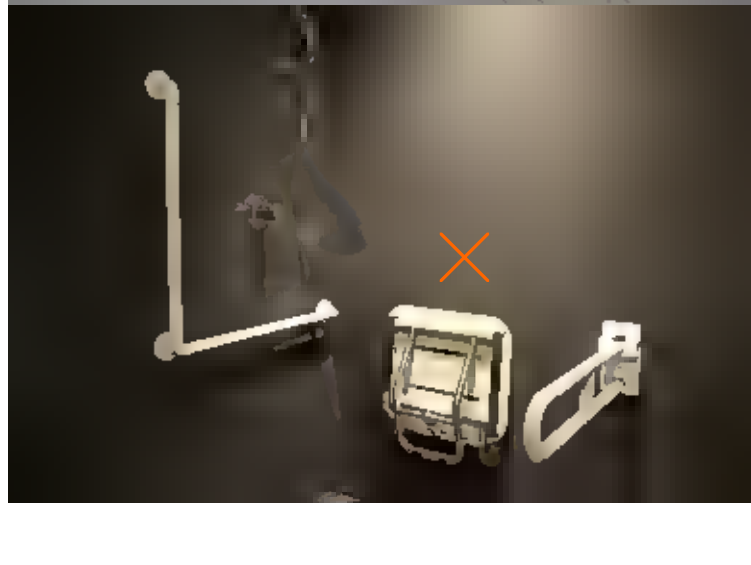

增加扶手

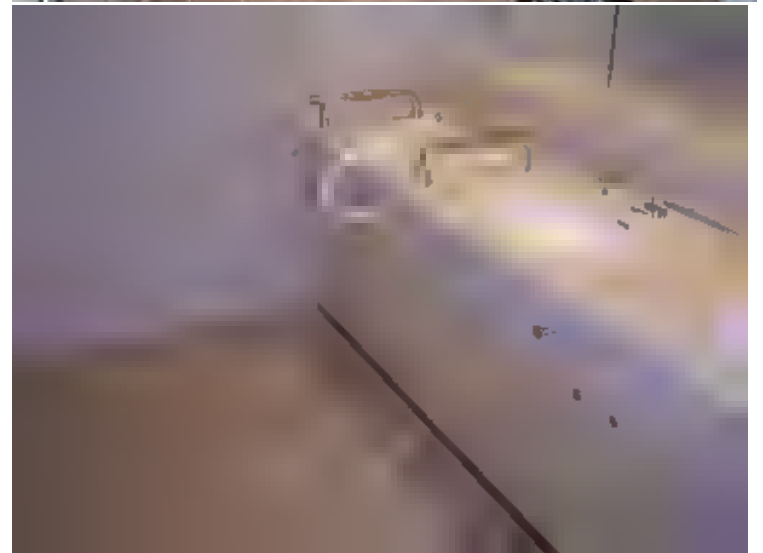
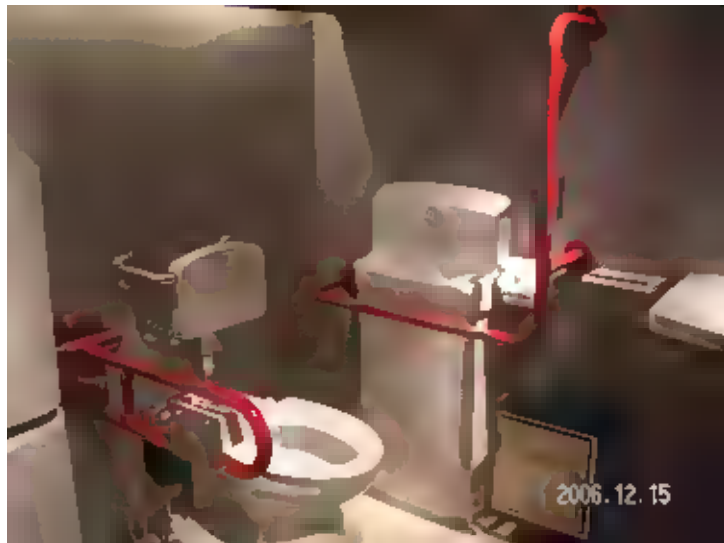

需要協助的醫療馬桶



寢室擺設座椅式夜壺



室內廁所配備



老人住宅便器

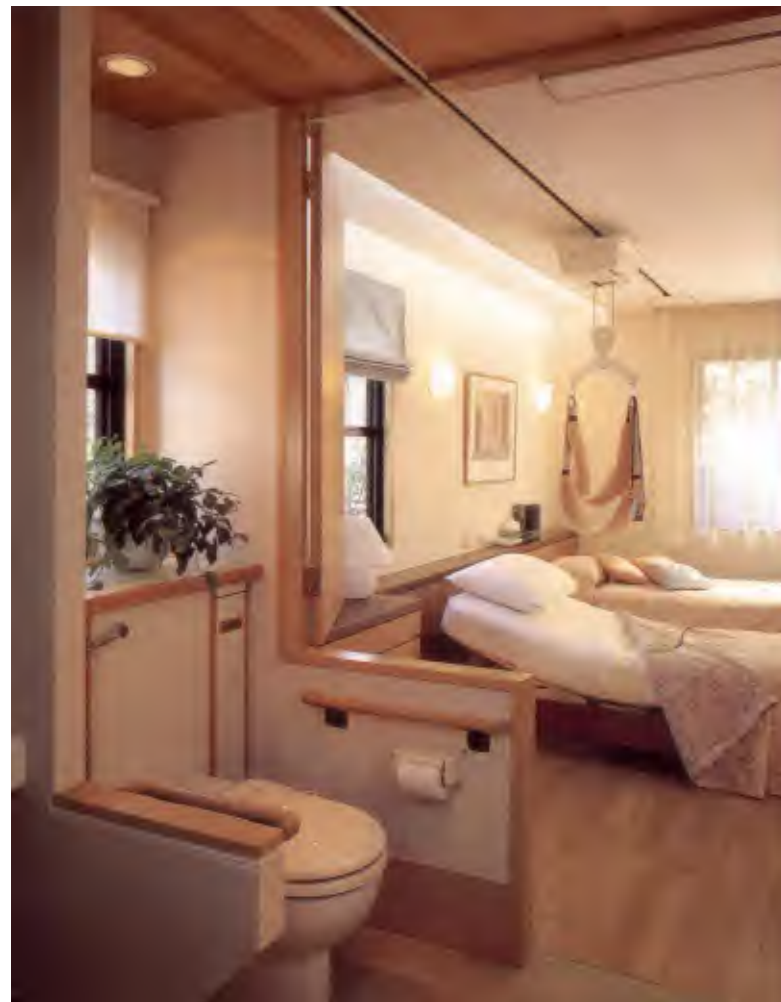

日式、歐式的廁所

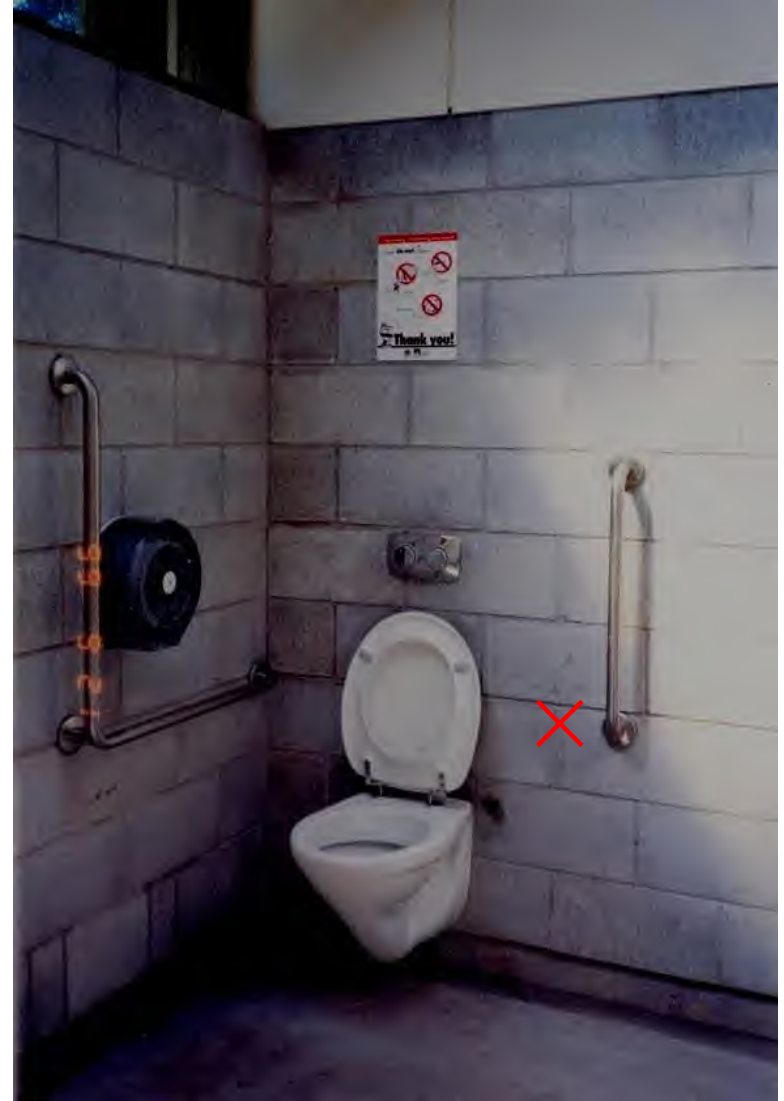

日本新舊式的廁所



日本老人可用廁所

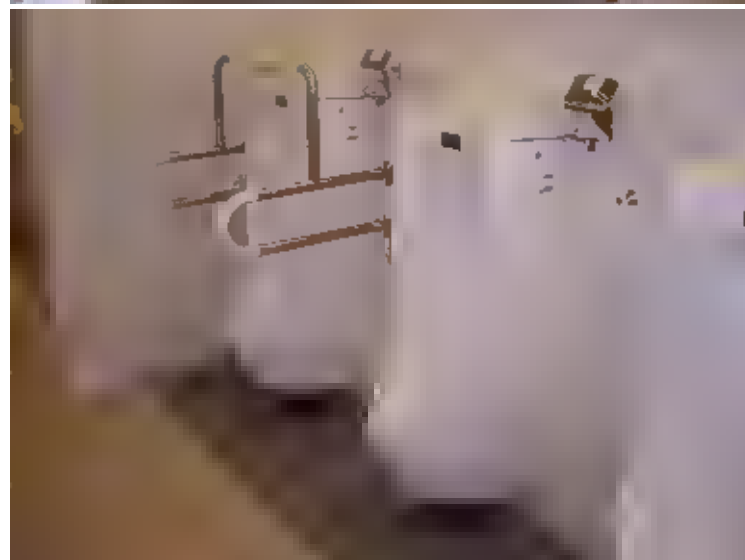

蹲式便器的配置

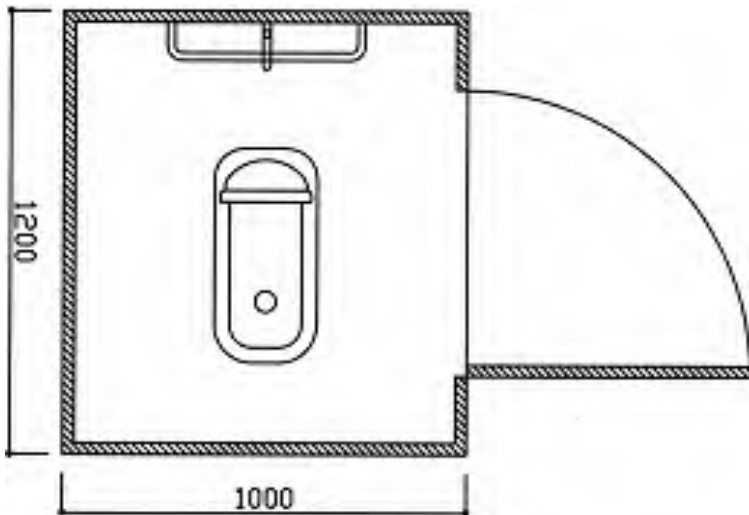

增加扶手

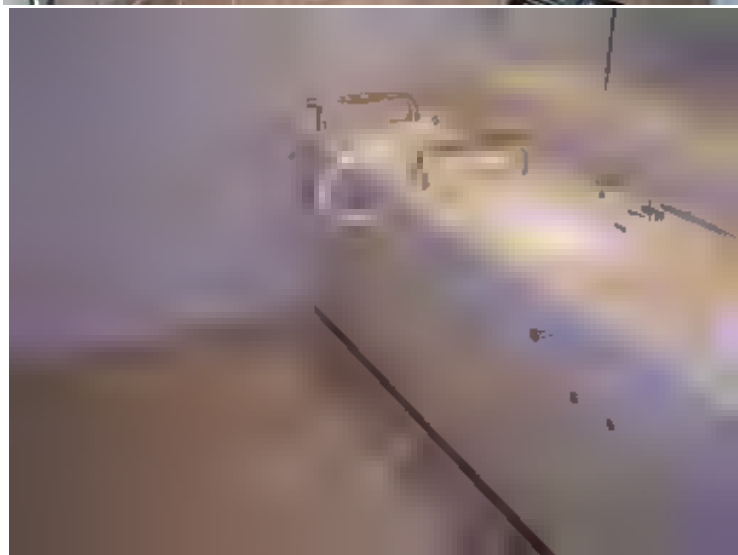

増設扶手

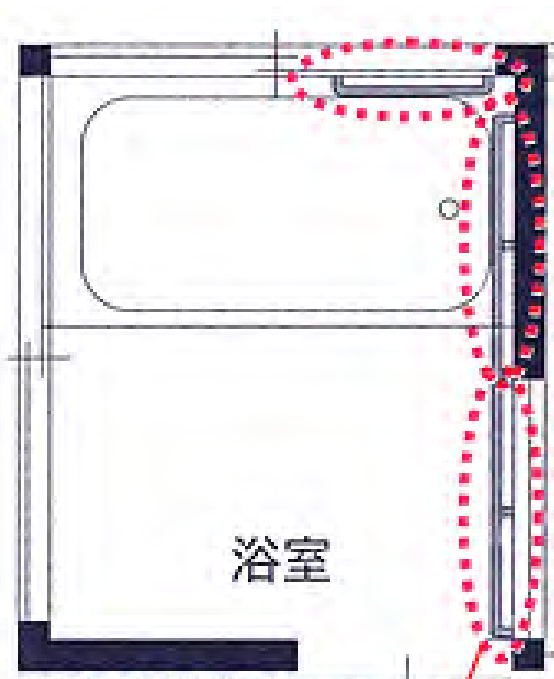
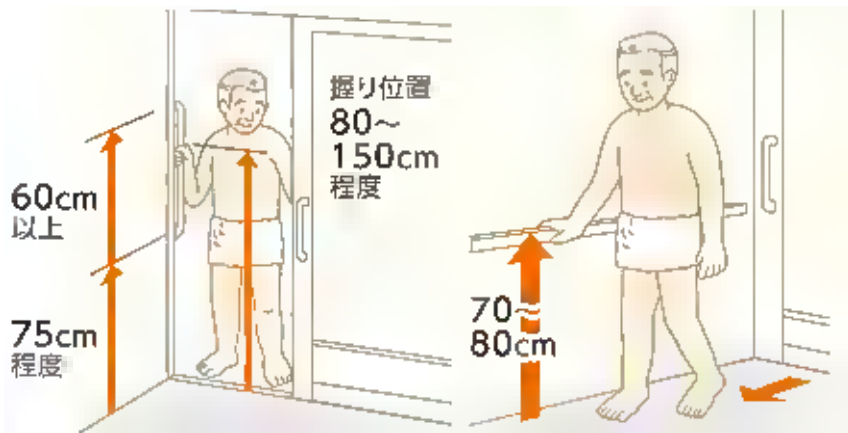

手すりの取付け部分



需要協助的醫療馬桶



馬桶的樣式



增設馬桶扶手



馬桶增設扶手



馬桶增設扶手

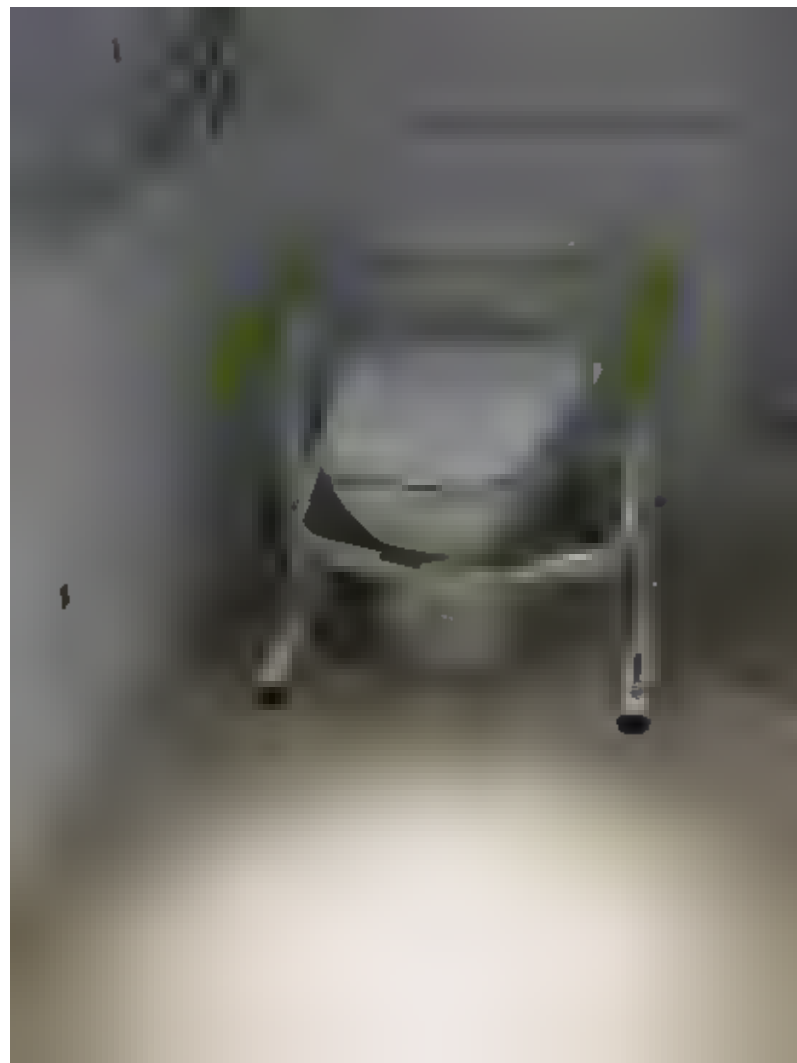
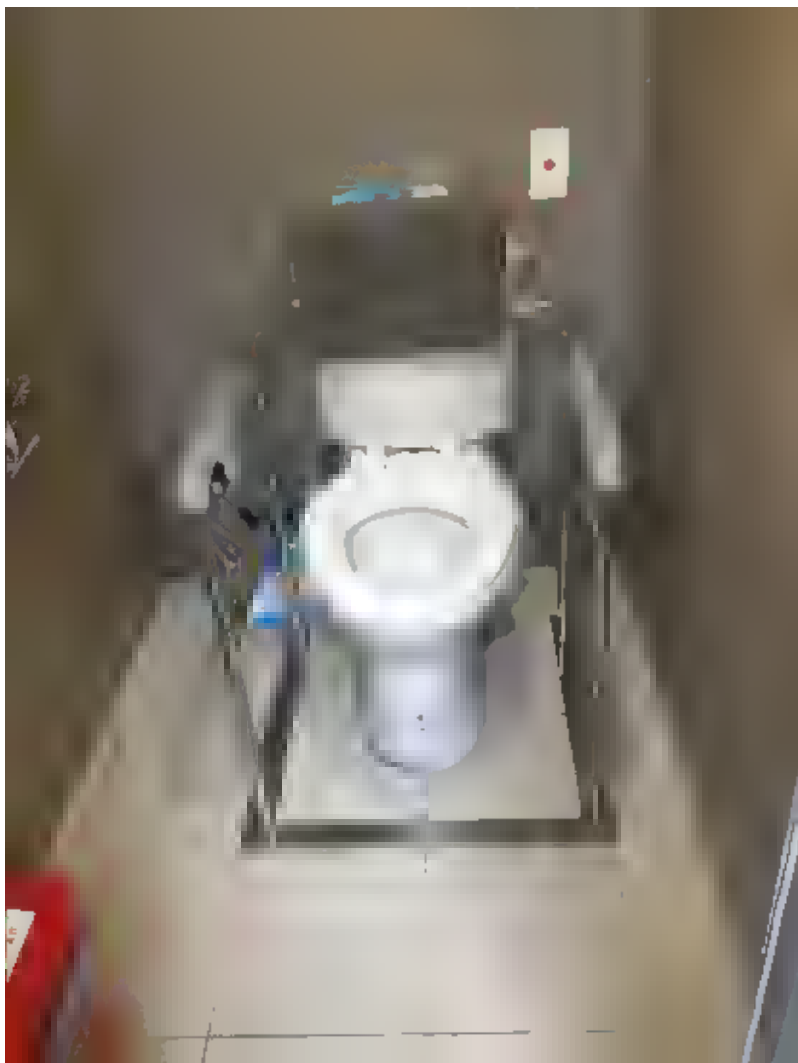

馬桶扶手日本





圖 3-10 蹲式便器施工示意圖



圖 3-11 輔助蹲下站立之扶手

淨下器

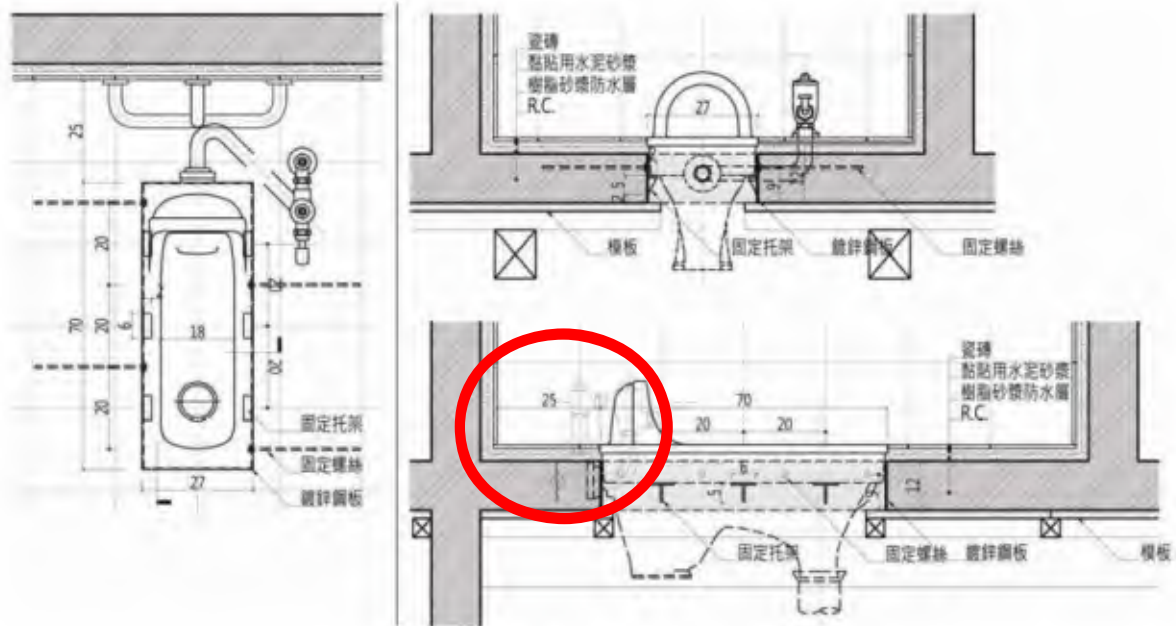

穆斯林用淨下器

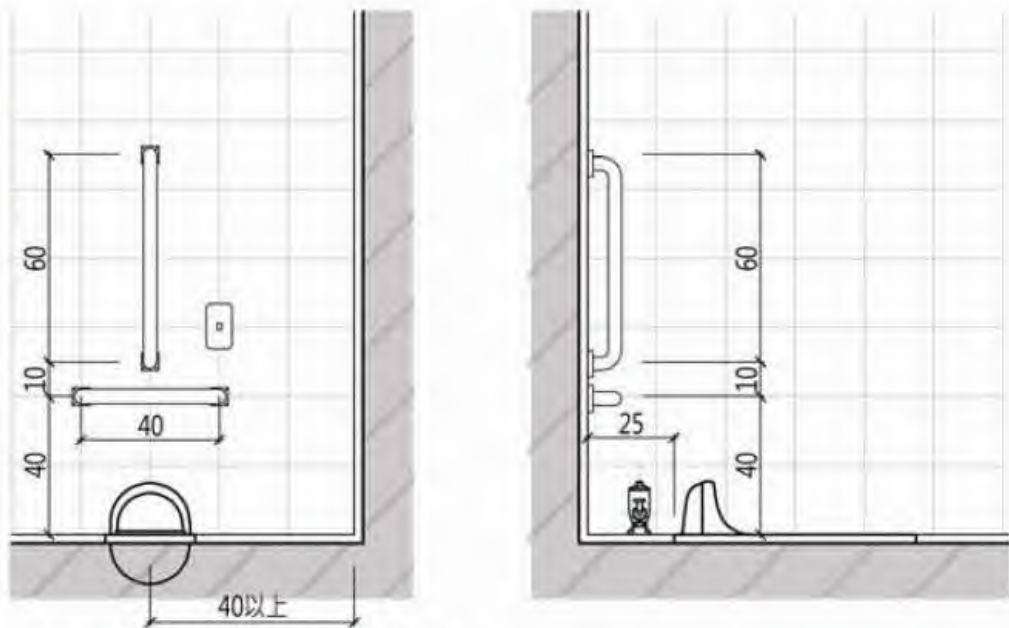
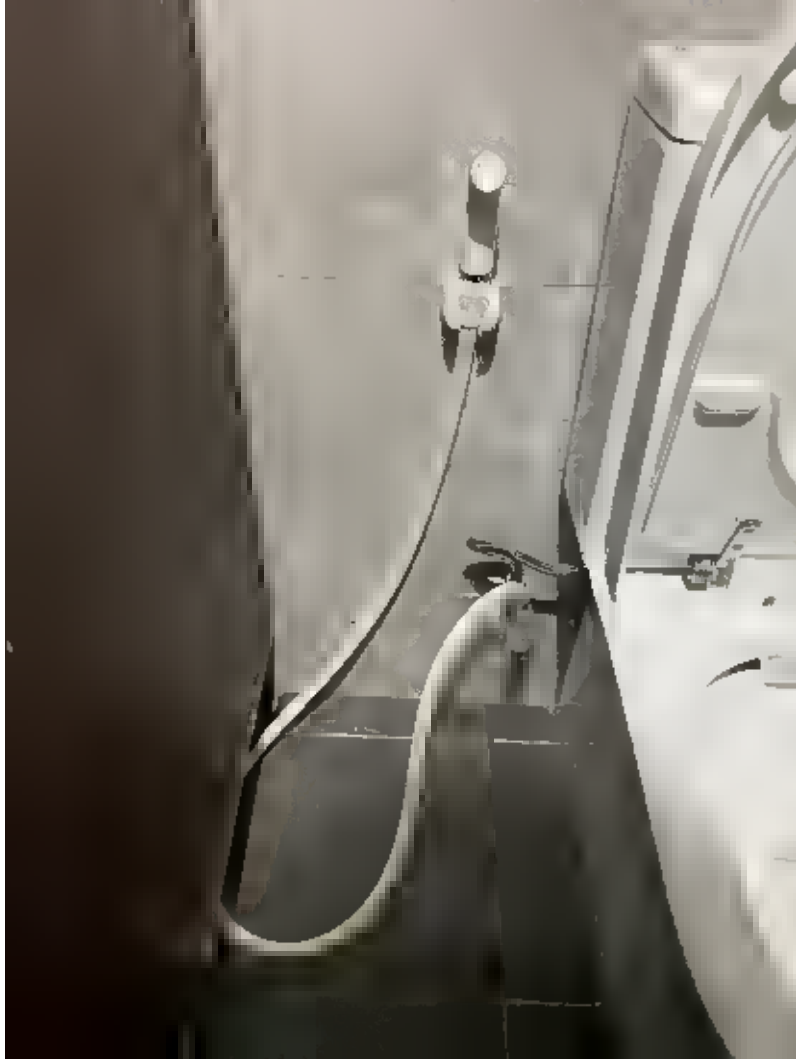
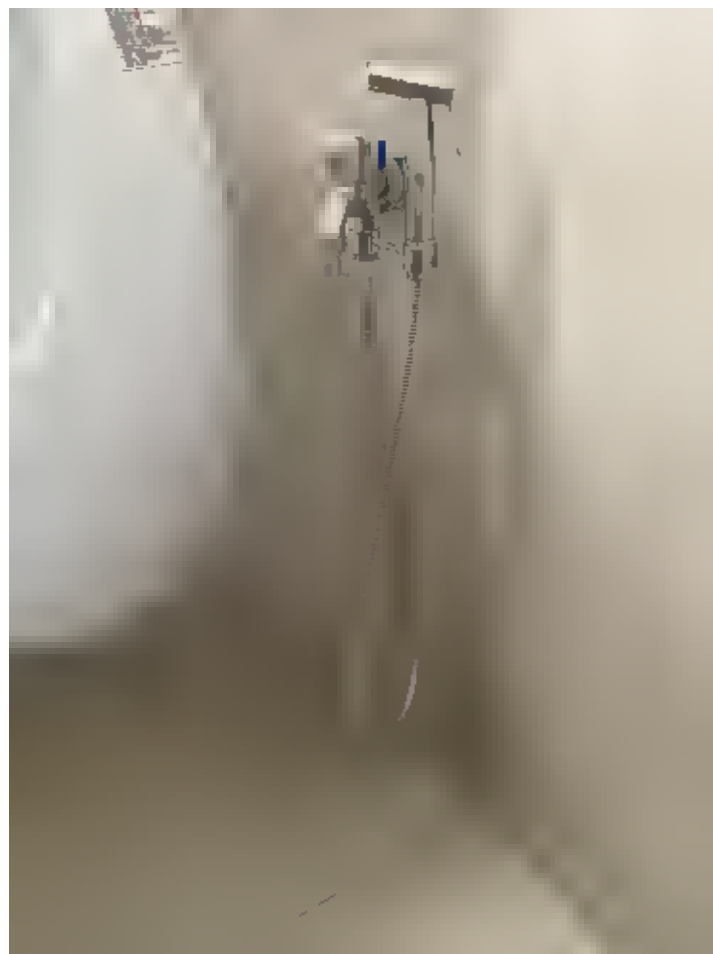

順暢排便的姿勢

Anorectal Angle

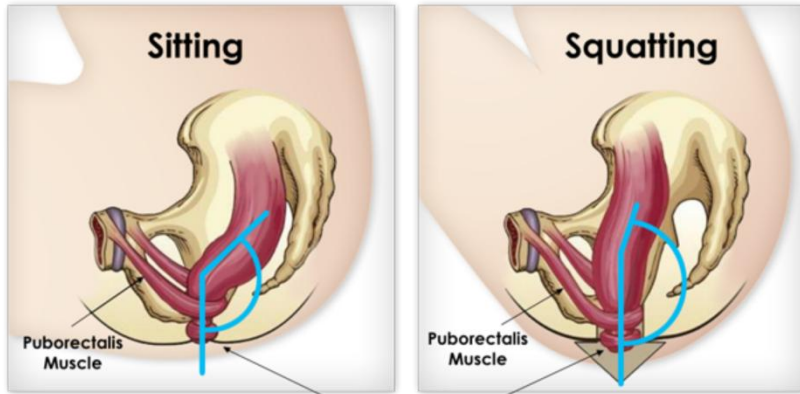

Sphincter

Squatting is the only natural defecation posture



squatty potty :)

35°

This convenient, sturdy structure is engineered to mirror the angle and efficiency of natural squatting, while allowing for the luxury and comfort of your own toilet.



免痔清洗設施 老人延壽原因之一



日本老人可用廁所

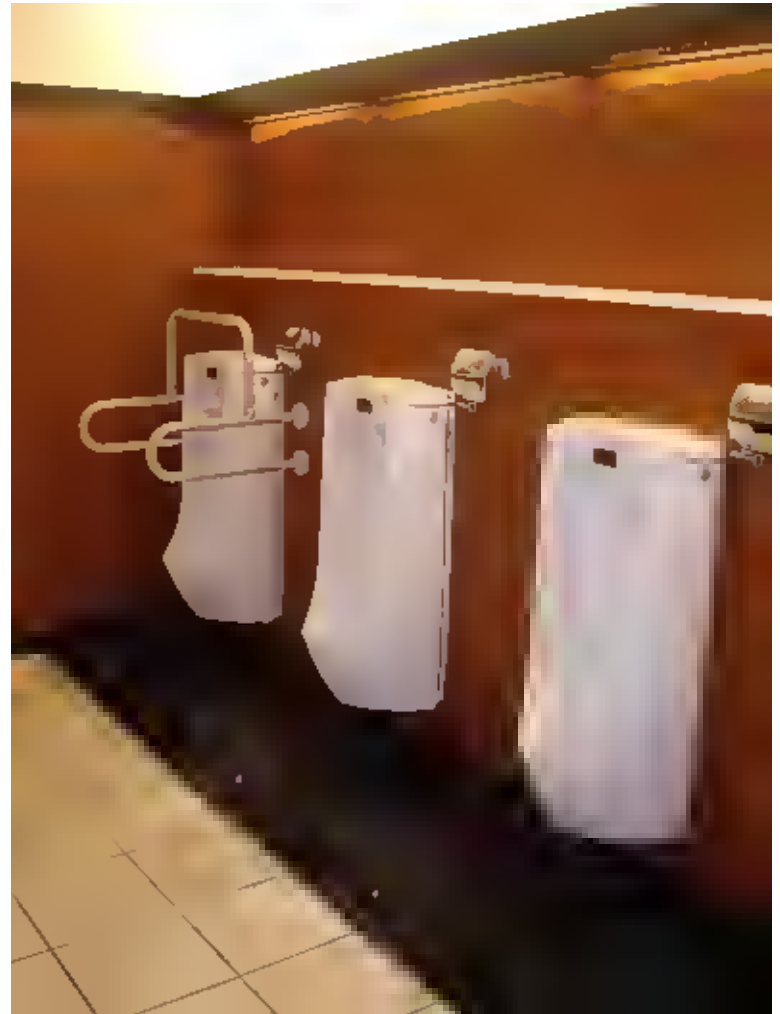

□左圖是顏色優化處理



小便器設置



老人滴尿状況

①老化度1
40歳を過ぎると手の振り方が激しくなる。



②老化度2
さらに老化が進むと腰を振るようになる。



③老化度3
60歳前後でひざを曲げて足腰を振る。



④老化度4
スポンを少し下げないと排尿できなくなる。

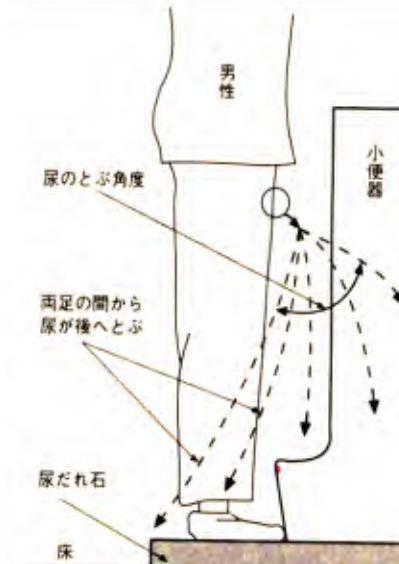
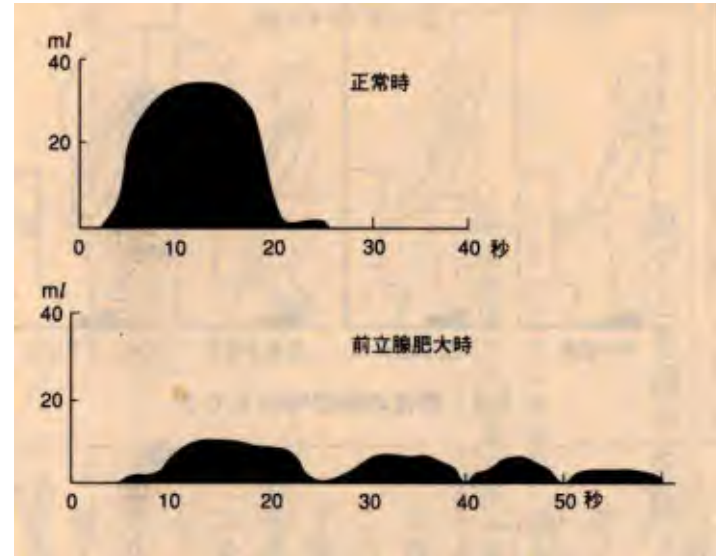

立式小便器、扶手



小便斗底部與地面留有空間，方便清潔不會殘留尿垢而發臭



圖 A205. 5. 2

漏尿口的高度不要超過**38~35**公分，以利輪椅使用者漏尿及方便小孩使用

盛滴尿口

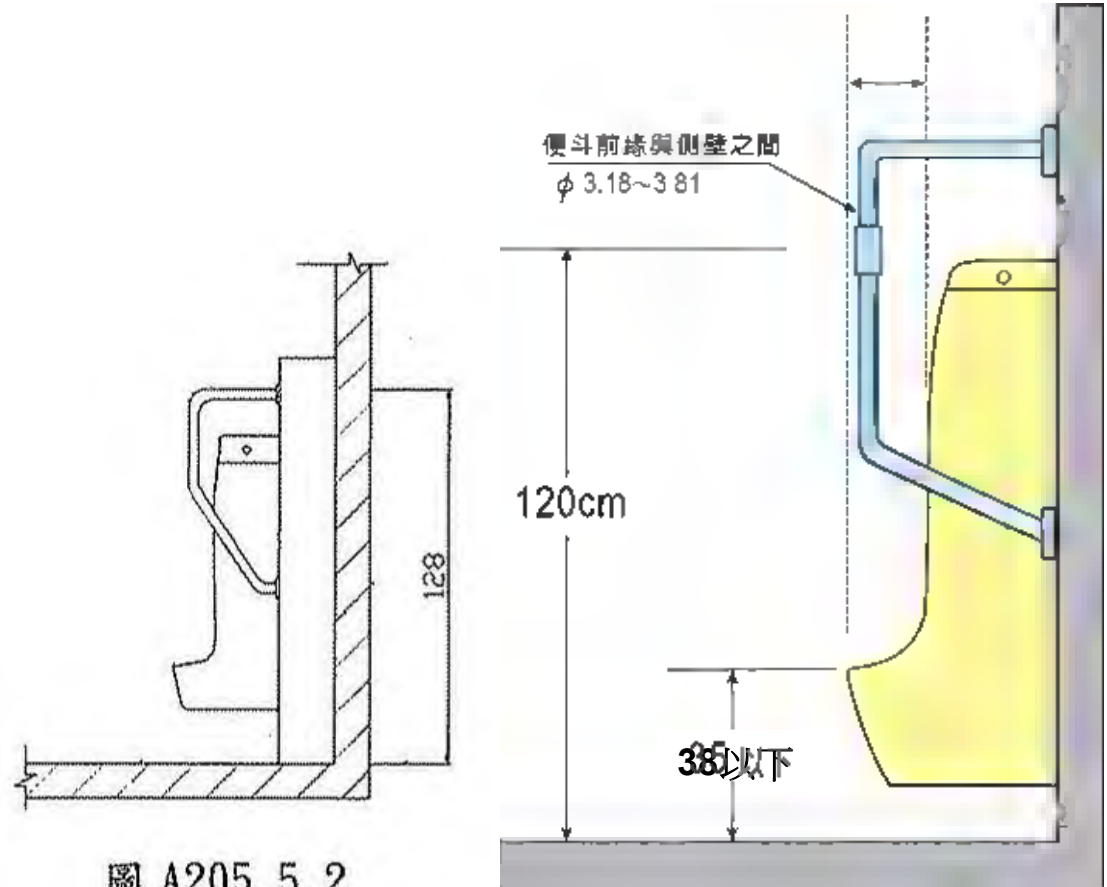
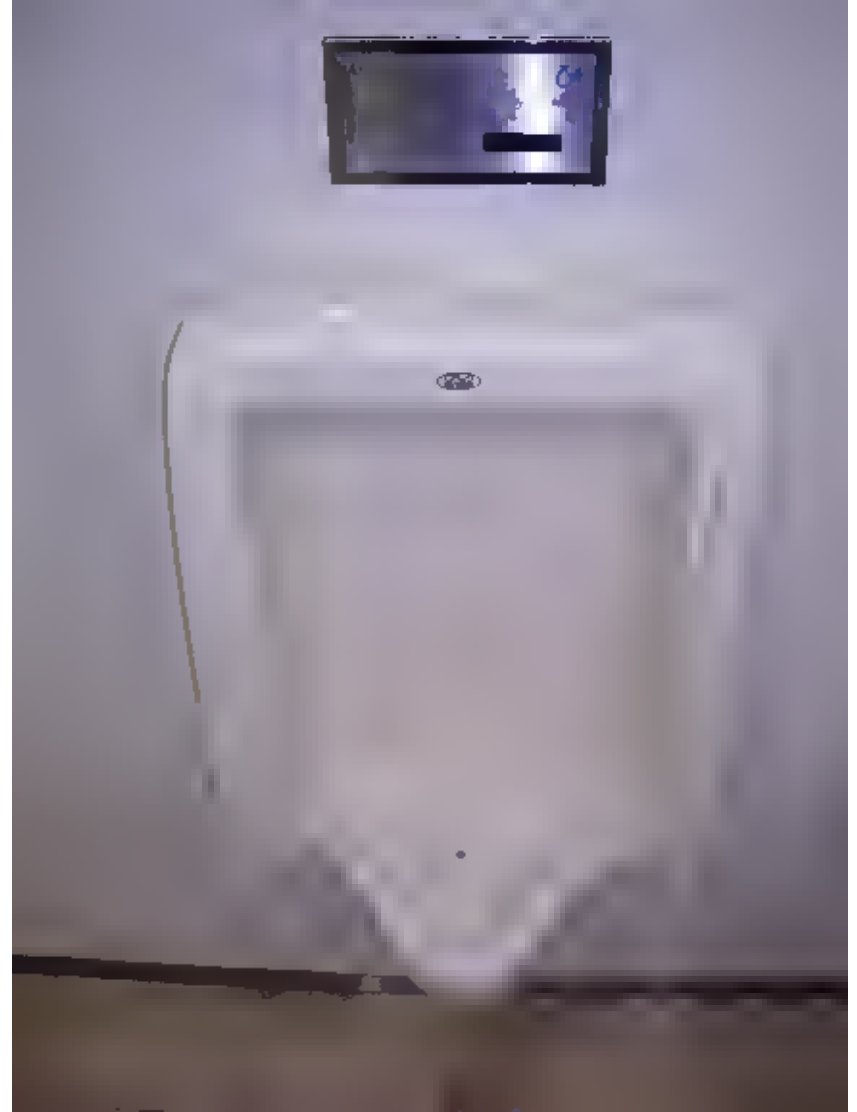
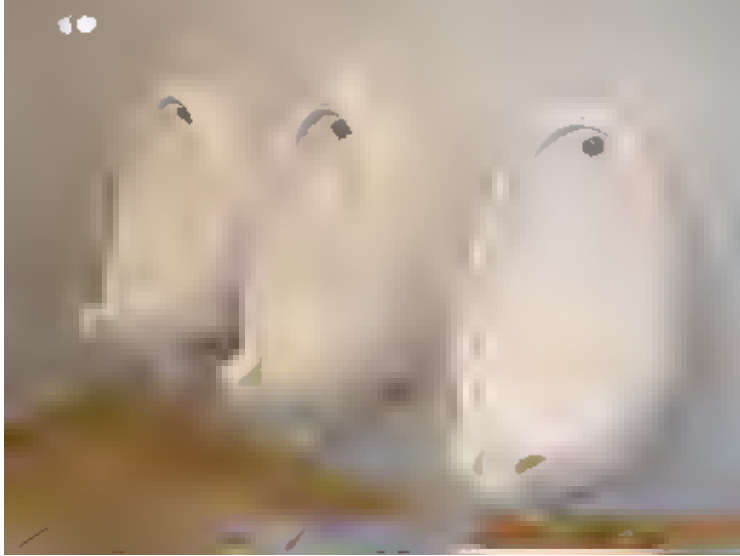

小便器扶手



小便器優缺點比較



小便器扶手一比較



此型扶手有四個著力點較為穩固，且中間還有一根橫槓可依靠，是較為理想之扶手



小便斗扶手



此型扶手會妨礙持雙柺者靠近小便斗，但適合老人使用

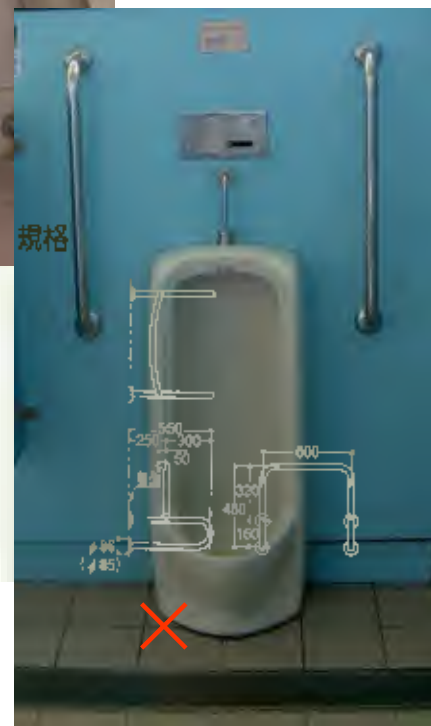

規格

立式小便斗、扶手



小便斗底部與地面留有空間，方便清潔不會殘留尿垢而發臭



圖 A205. 5. 2

漏尿口的高度不要超過**38~35**公分，以利輪椅使用者漏尿及方便小孩使用

小便器的選擇

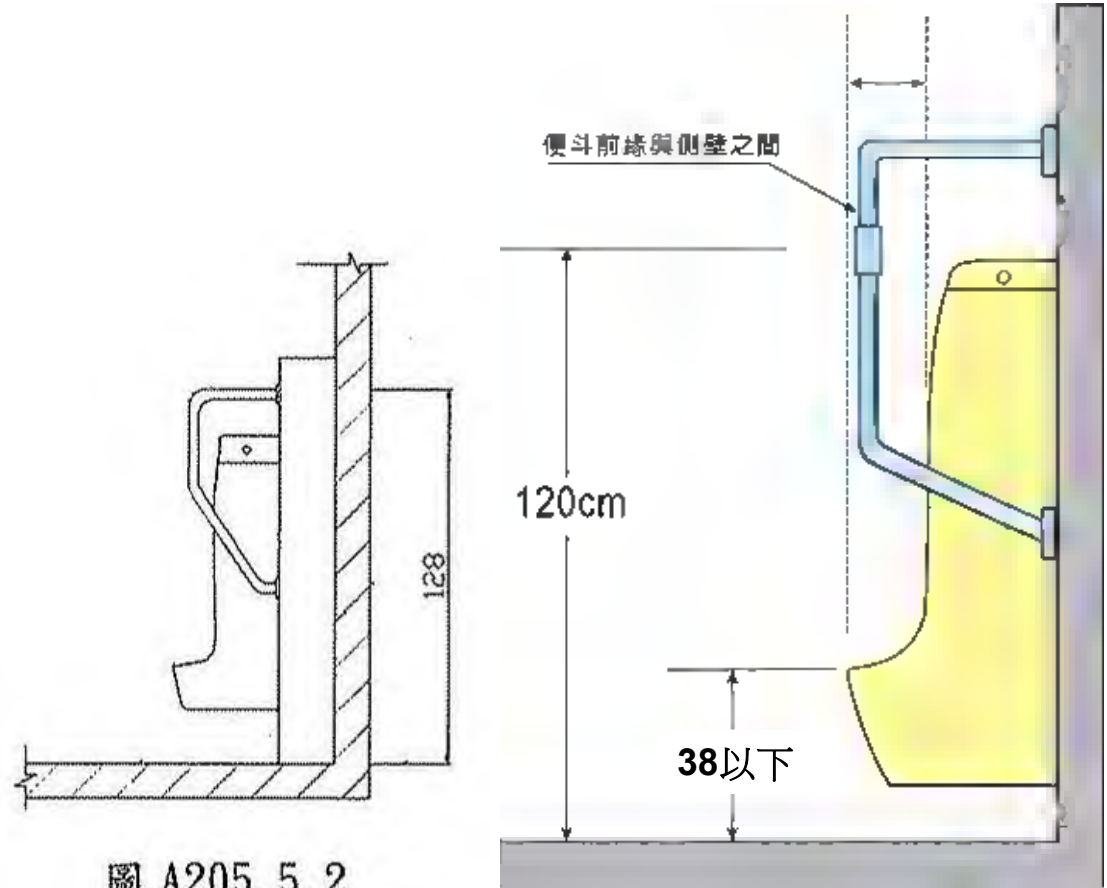
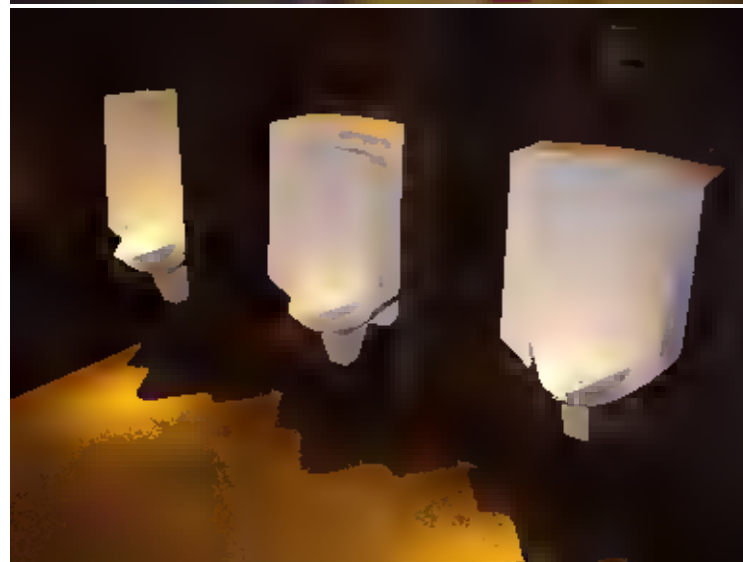

❑ 別忘了留設容腳板的空間

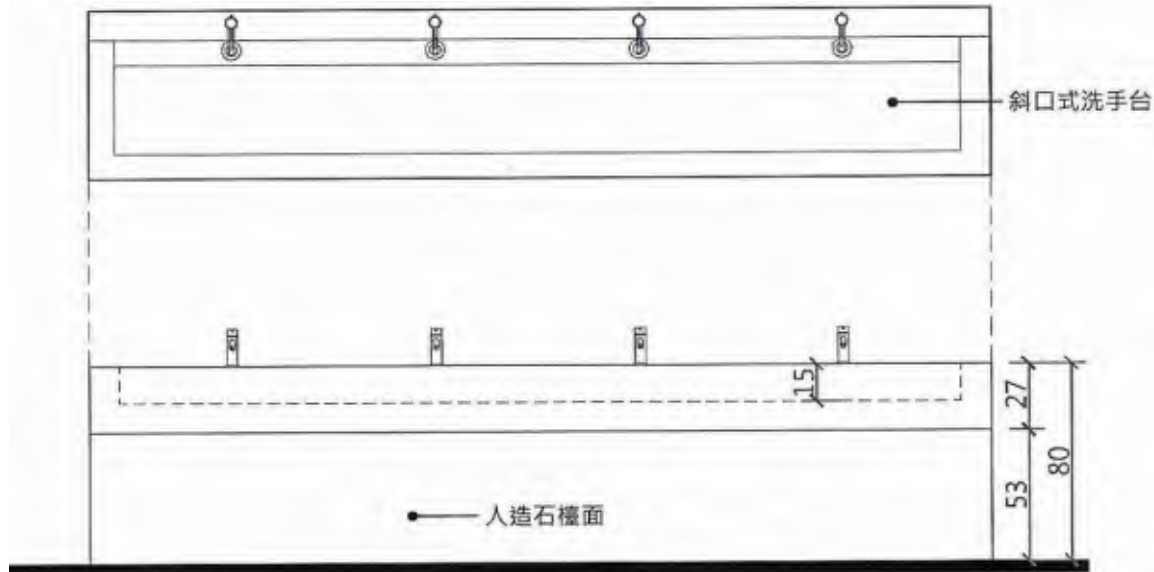

2 洗手台平立面詳圖
A3-4 UNIT: CM

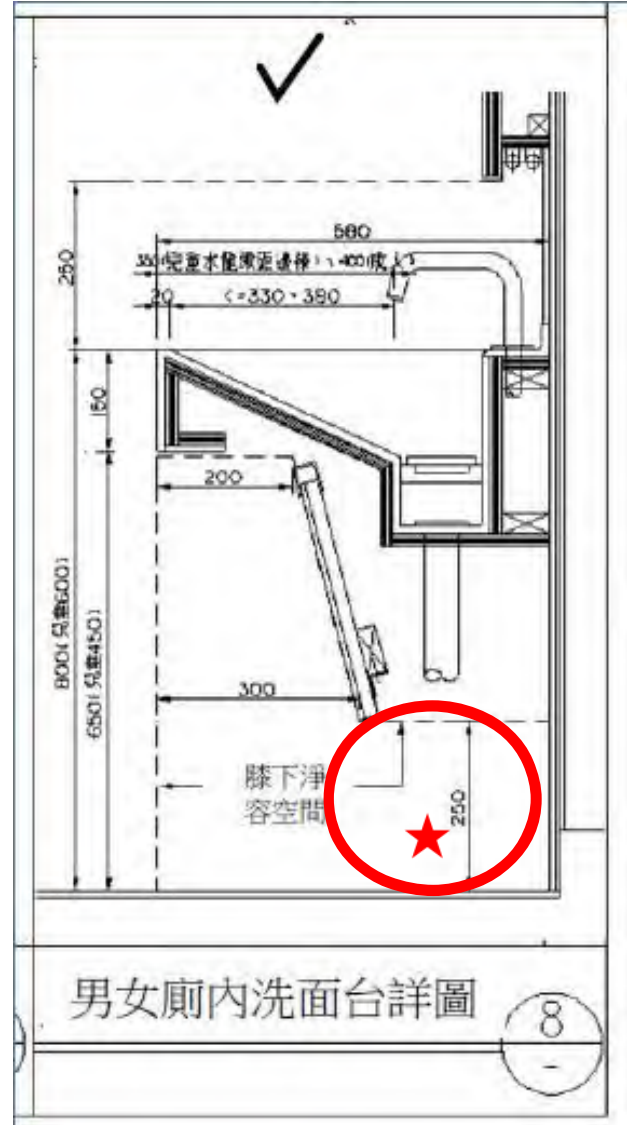
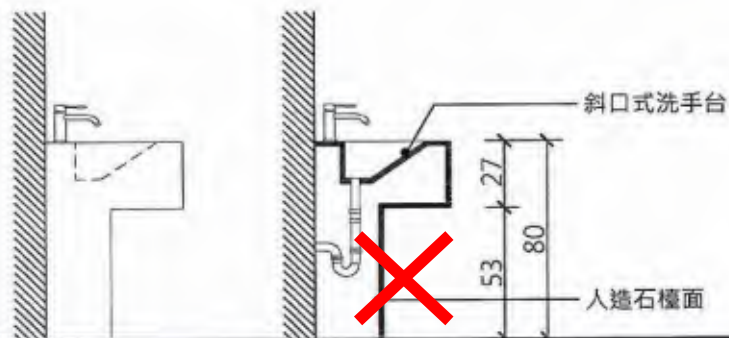

無法靠近使用

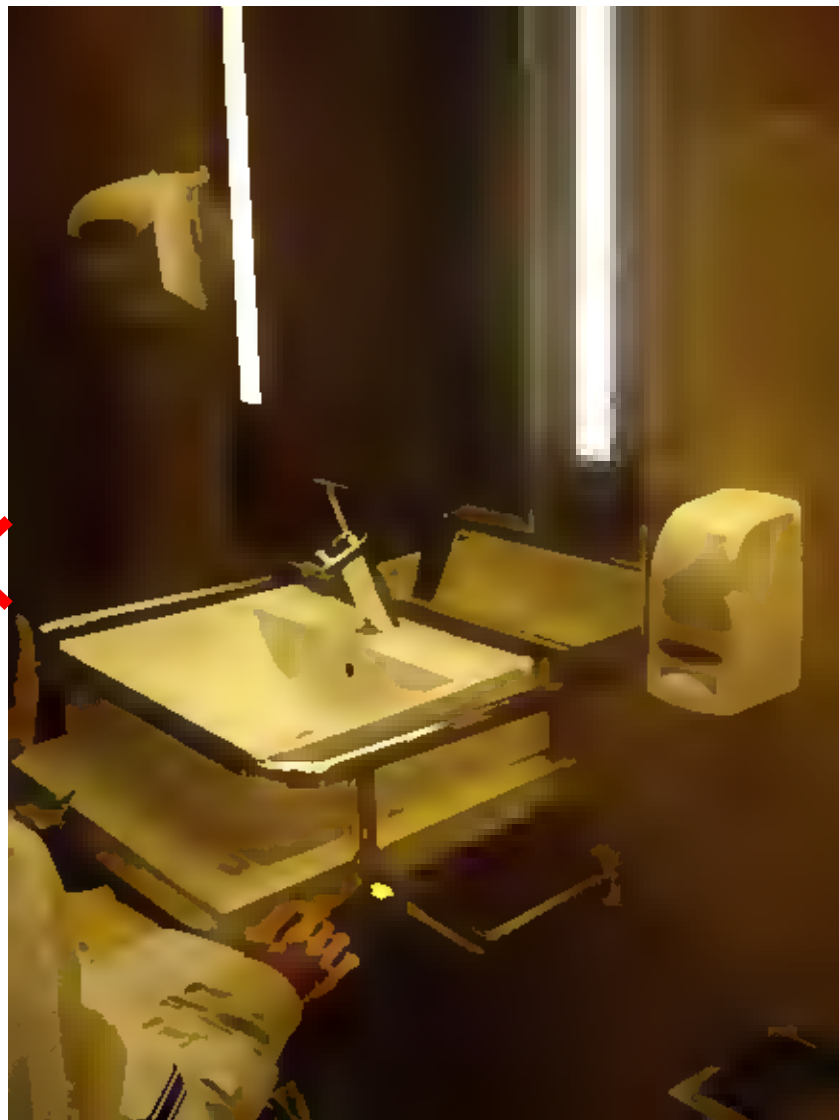

馬槽型洗手檯



有何不妥？

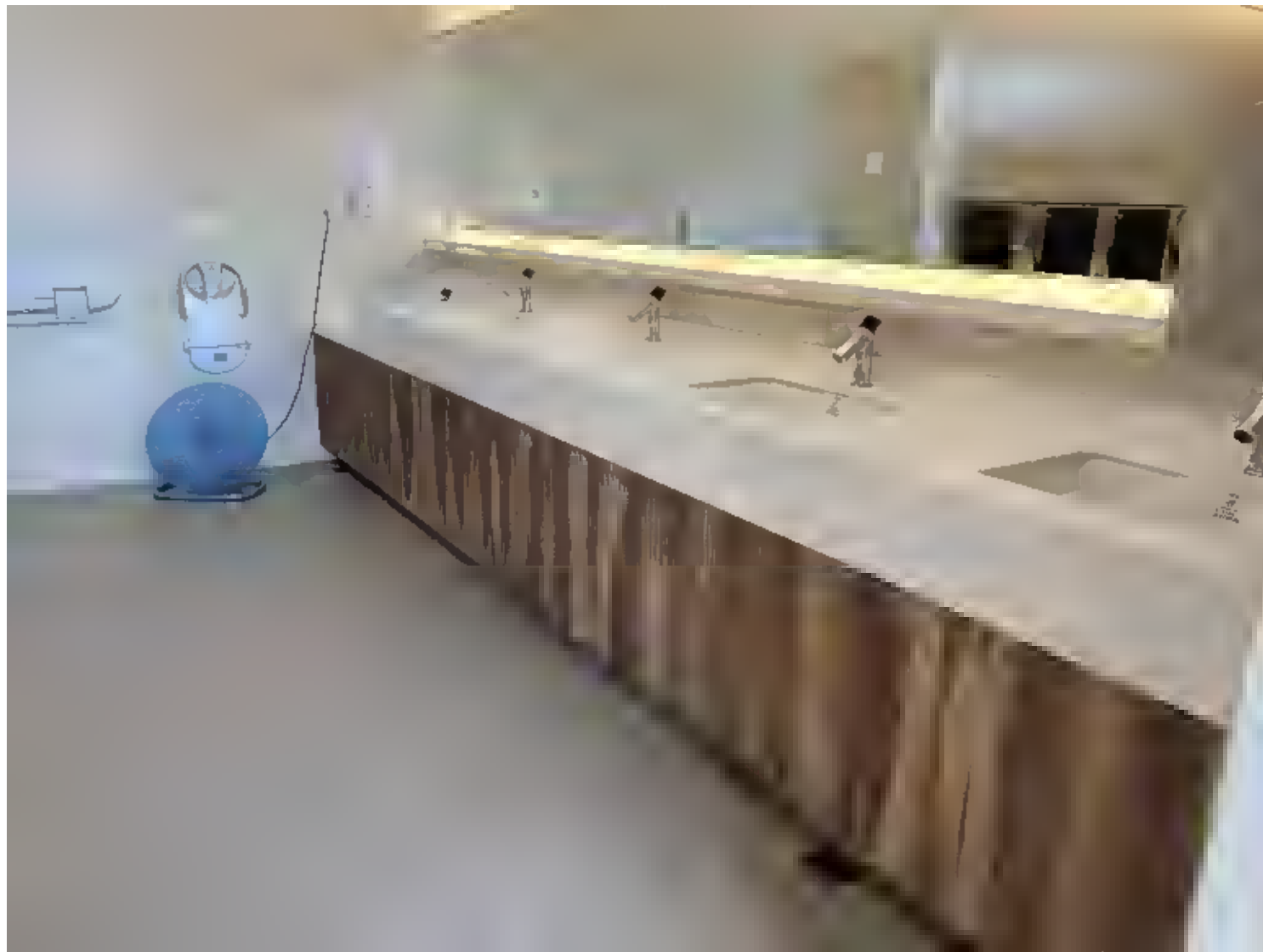

輪椅族無法洗手、臉

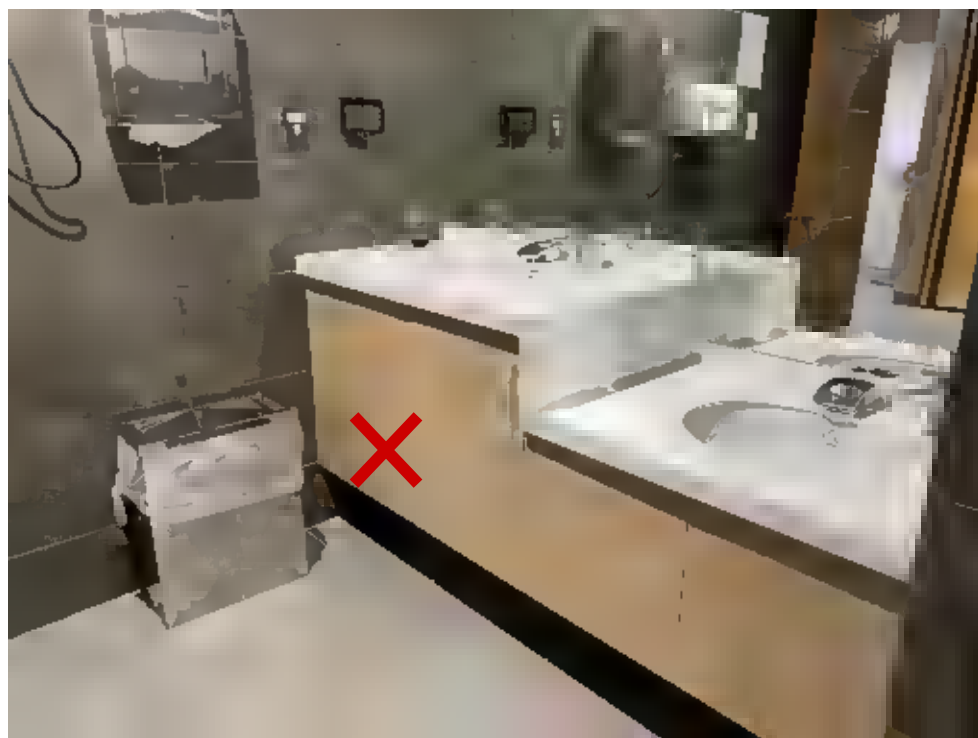

男廁外的洗面盆



下撑架洗面盆

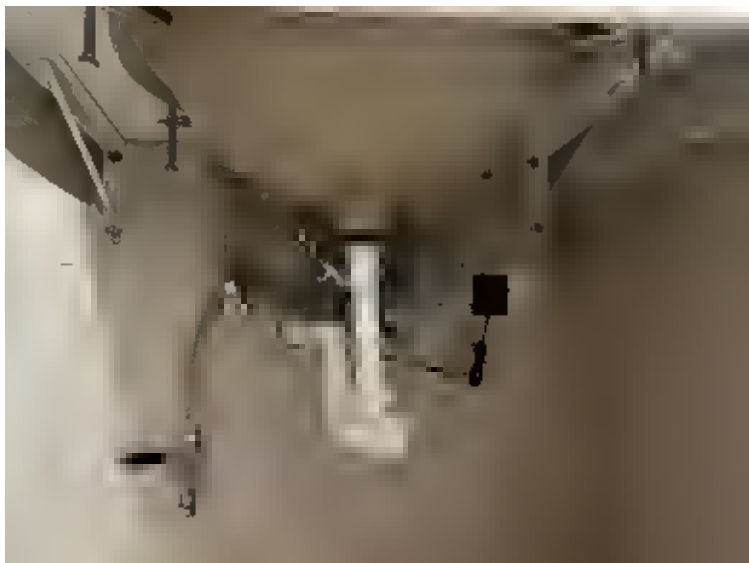

洗面檯扶手



歐式無障礙浴室一



歐式無障礙浴室二



歐式無障礙廁所



無障礙浴廁尺寸



老人安養院浴室



移動洗澡椅



介護者協助入浴 TOTO

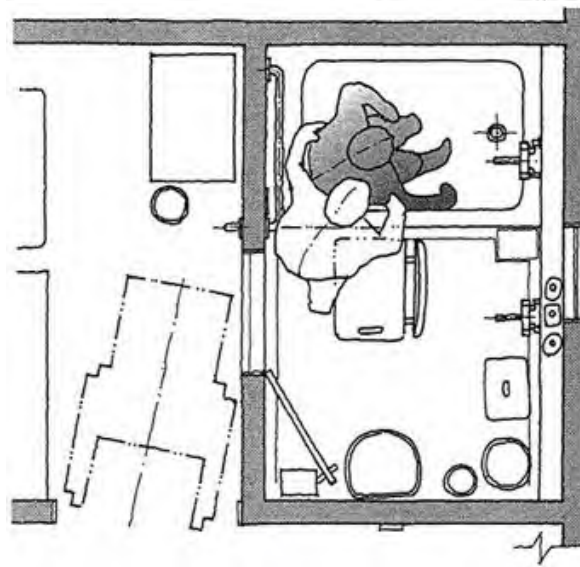
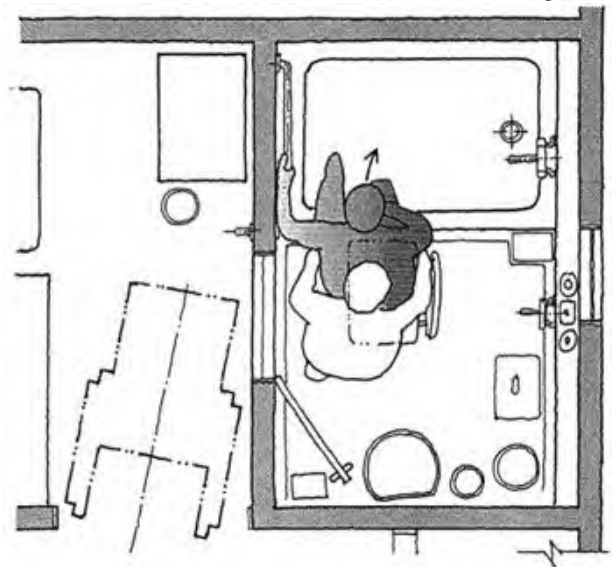
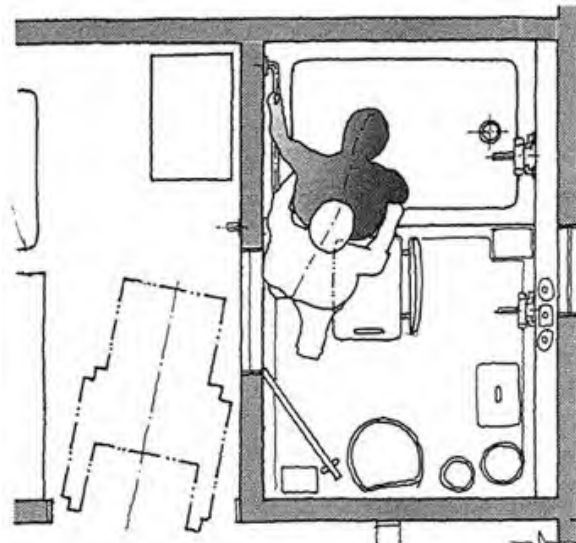
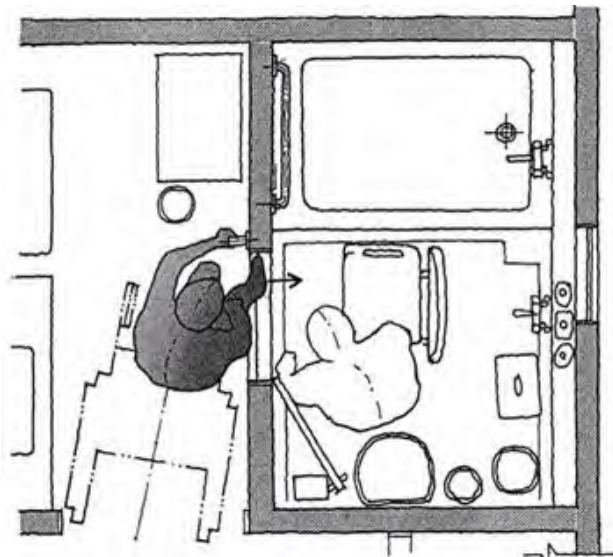

介護者協助沐浴



1. Transfers between a wheelchair and a toilet



2. Transfer between a bed and a wheelchair



改善浴缸深度



安全泡澡

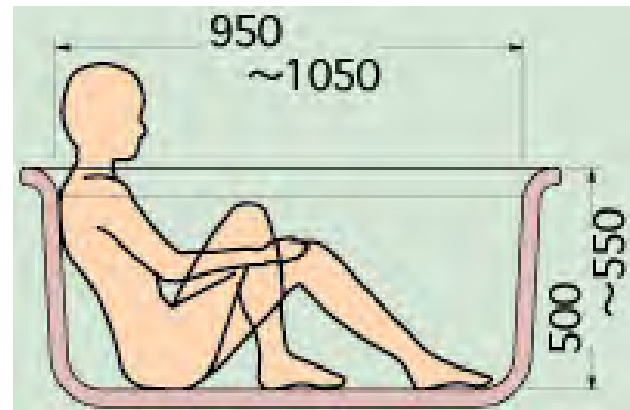
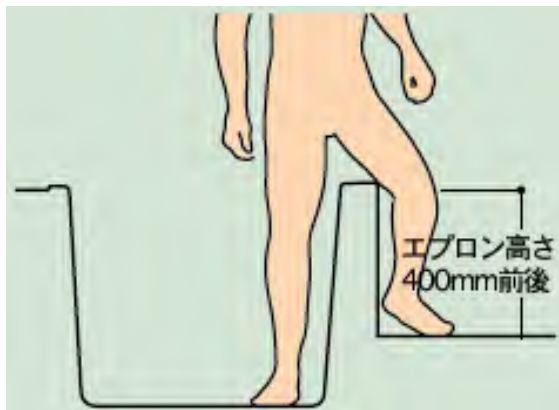
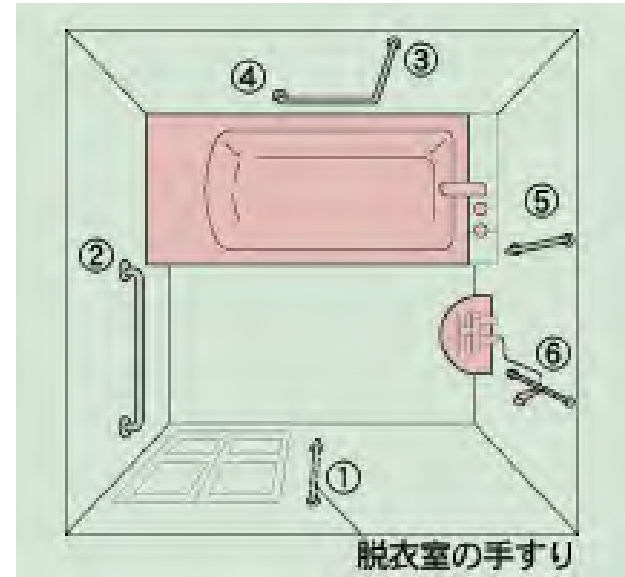
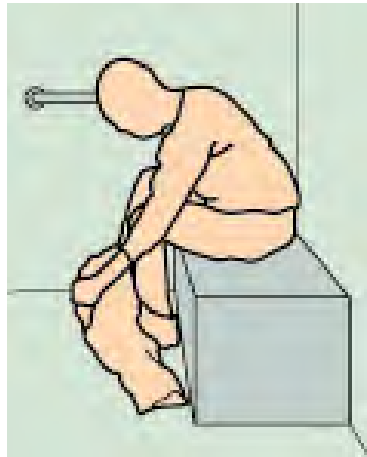

老人入浴補助

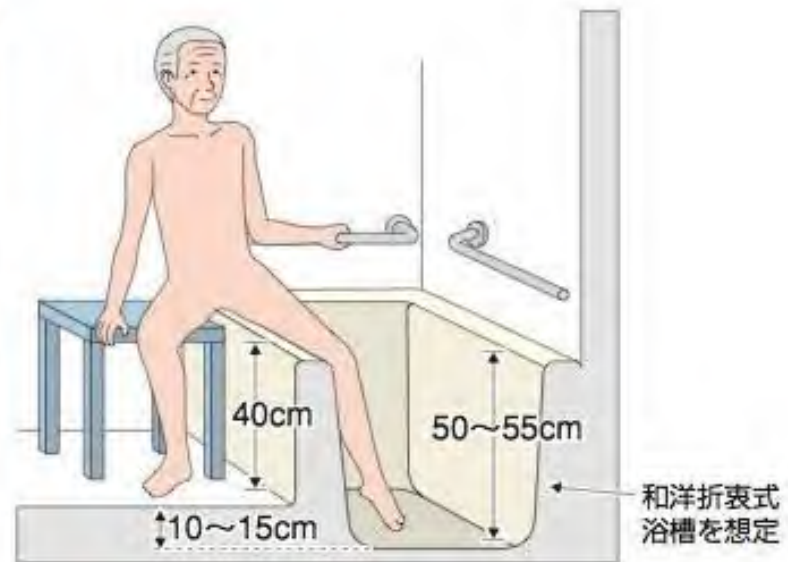
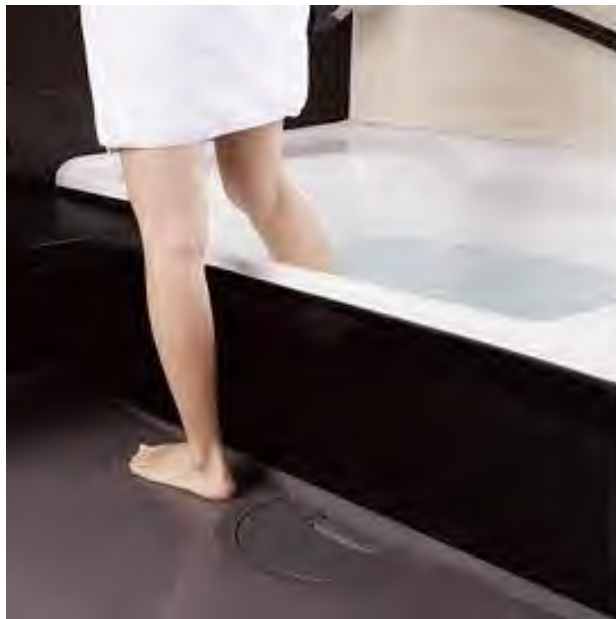

照護使用空間

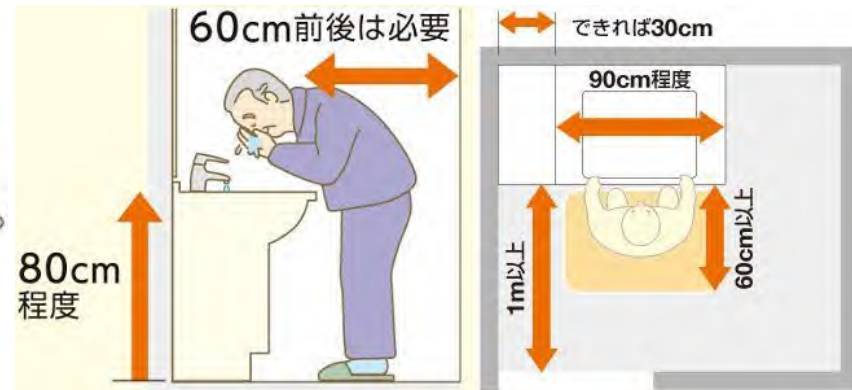
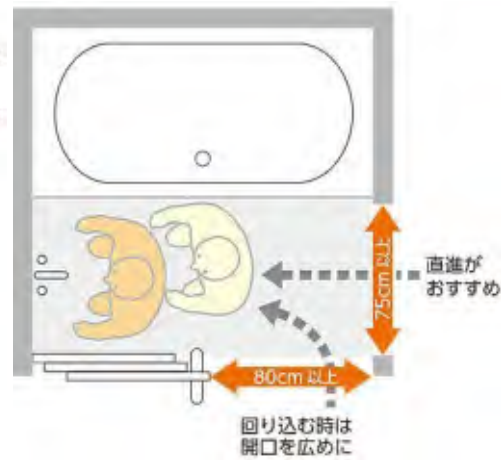
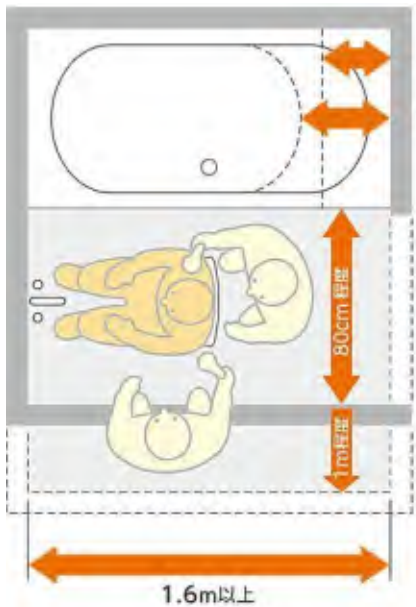

老人浴廁設施

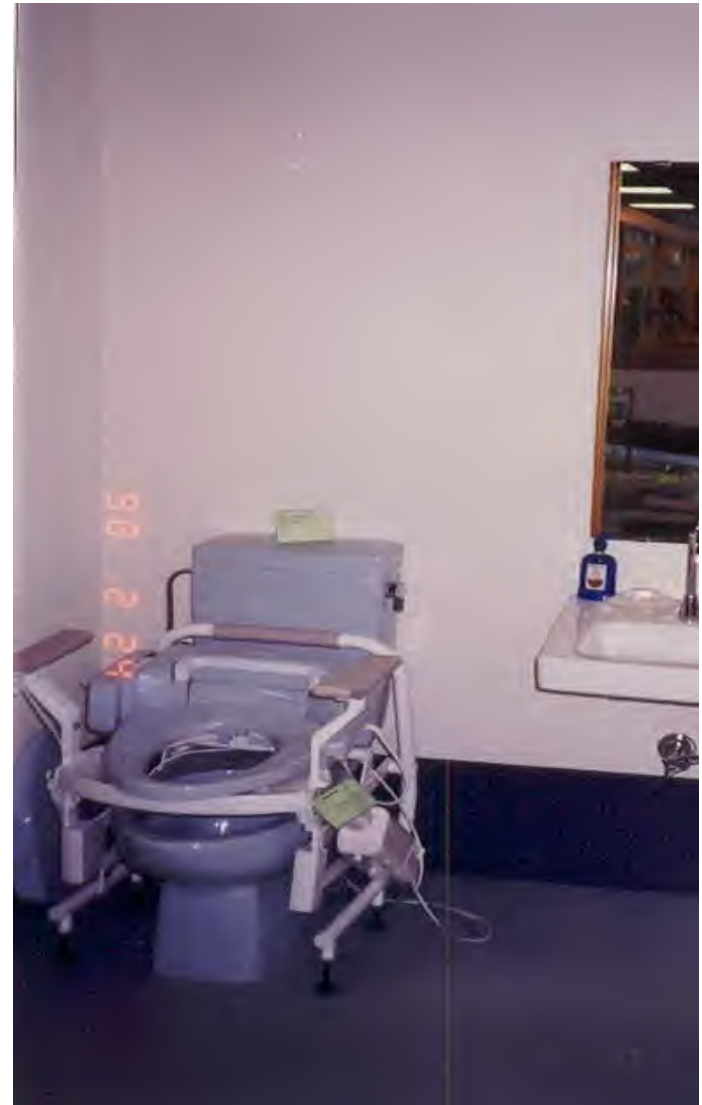

舊式懸吊協助



舊式懸吊協助



天花板懸吊架

・施工は1日でOK!
 改造はほとんどいりません。
 ※ワンルームです。ドア枠・換気扇の住宅改造は必要ありません。

①直線レール ②カーブレール ③移動用XYレール ④ドアフレーム ⑤交差レール ⑥斜めレール ⑦固定ポール ⑧XY用ポール

コンパクトなかるがるだから、
 トイレにも取付OK。

湿気に強いかるがるなら、
 浴室での使用も可能。
 ◇リフターにも防湿加工がしてありますので、浴室内での使用もできます。
 ◇レールは湿気に強いアルミ合金。浴室にも、もちろん取付OKです。
 ◇かるがるは、ポール・フレームが積立式なので、ユニットバスでも使えます。

移動用XYレールを使えば、
 お部屋のどんな場所へもラクラク移動。
 ◇移動用XYレールはレールそのものが移動しますので、部屋中どんな場所へも移動できます。[写真E・F]

淋浴設備



淋浴設備



老人洗澡椅

折疊式安全護欄淋浴椅



產品特性:防水(康貝特板)、防鏽(SUS304)、可折疊不佔空間、安全護欄(可調整)
使用場所:養老院、三溫暖、醫院、一般家用
載重:300KG

洗澡椅

H-1001
Deluxe Adjustable Flip Arm Shower Seat



H-1002
Deluxe Adjustable Flip Arm Shower Bench



移動式洗澡椅

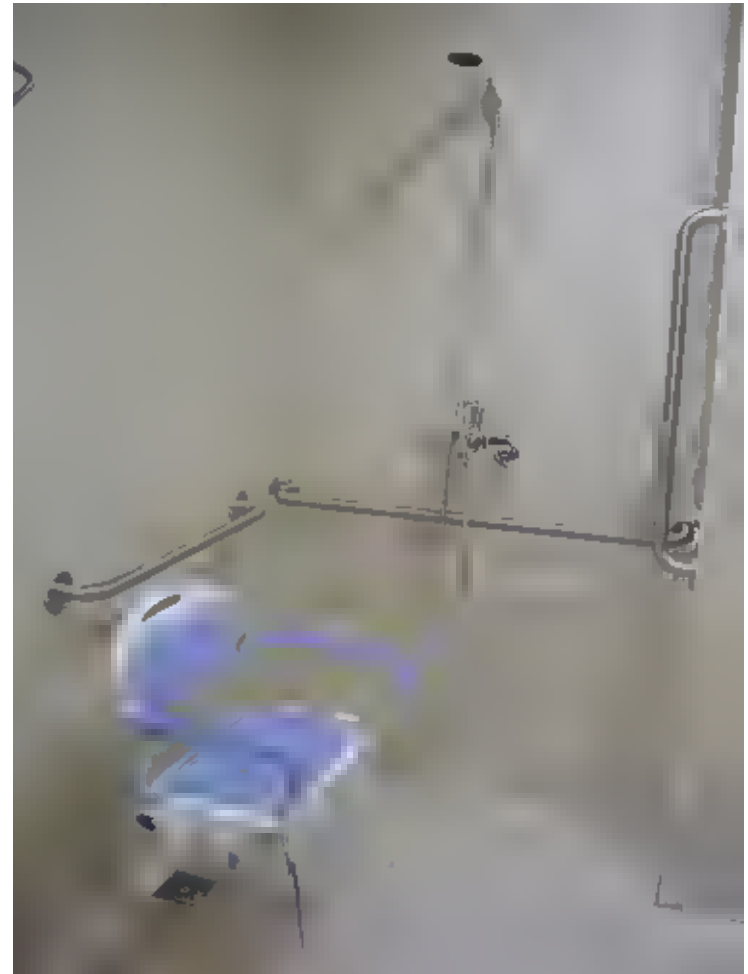

有扶手的活動洗澡椅



□ 洗澡蓮蓬頭 美國 右上、台灣 右下

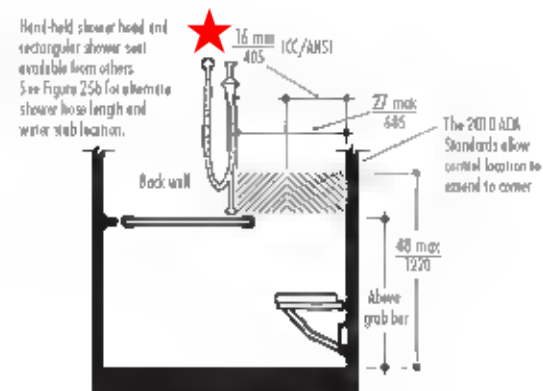
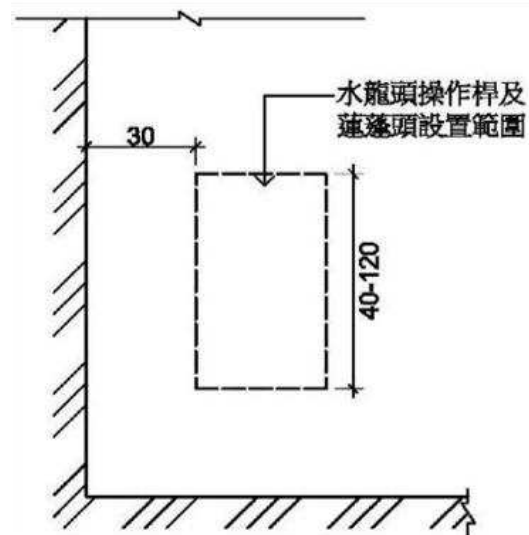

Fig. 24b Control Locations (with Seat)



浴廁牆面材料



協助洗澡設備

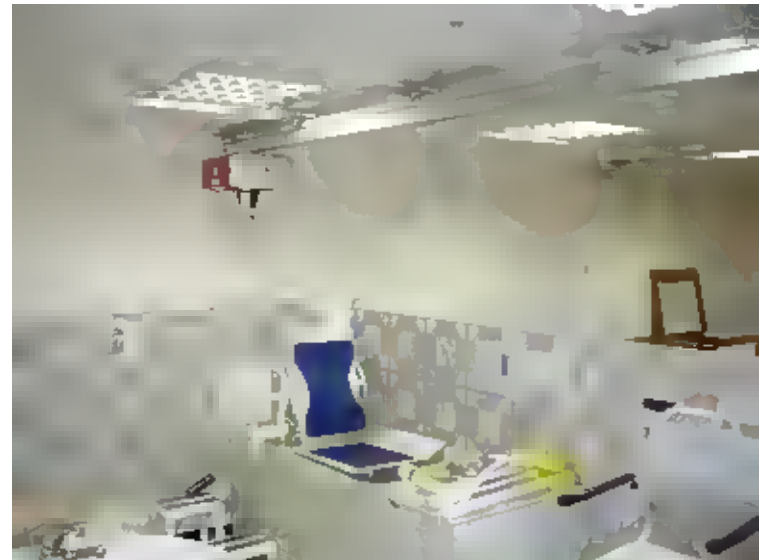
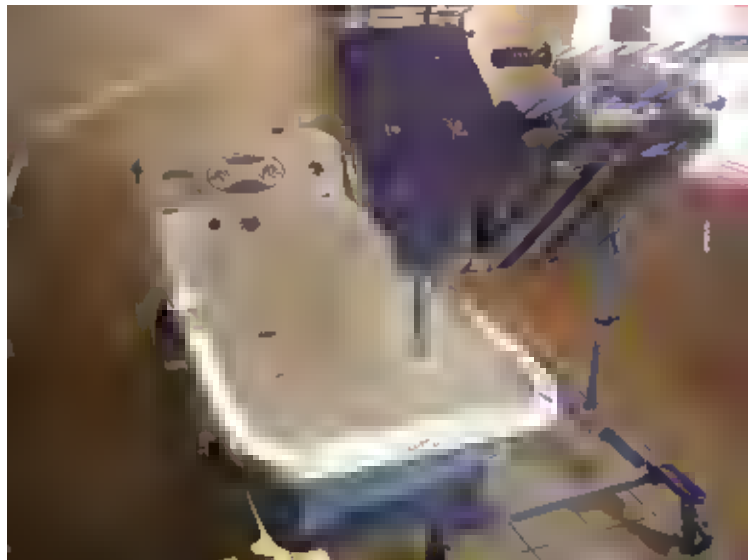

走入式浴缸

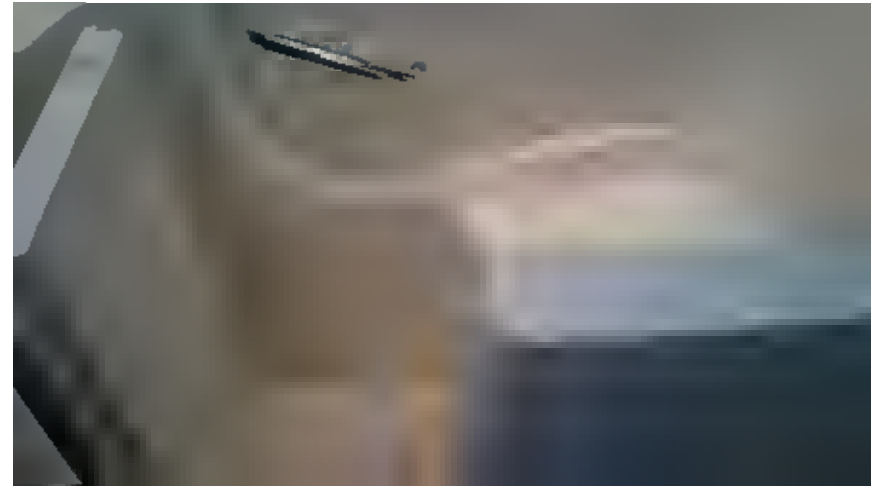
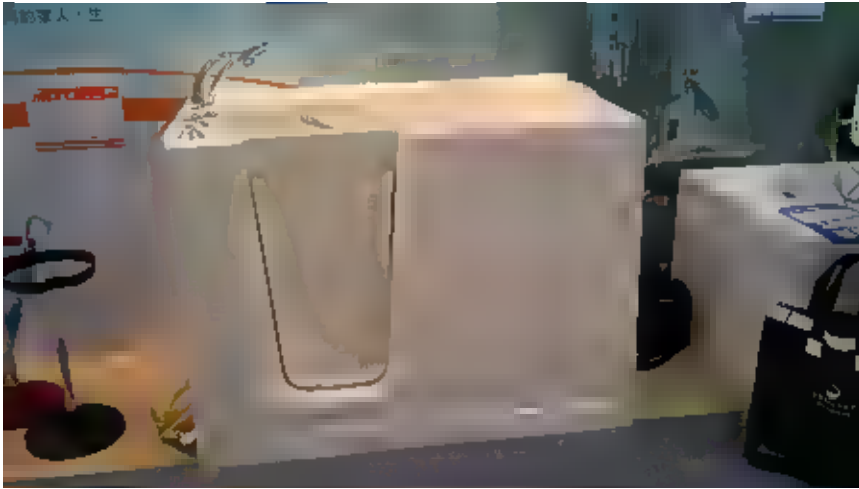

照護型浴缸



洗澡床

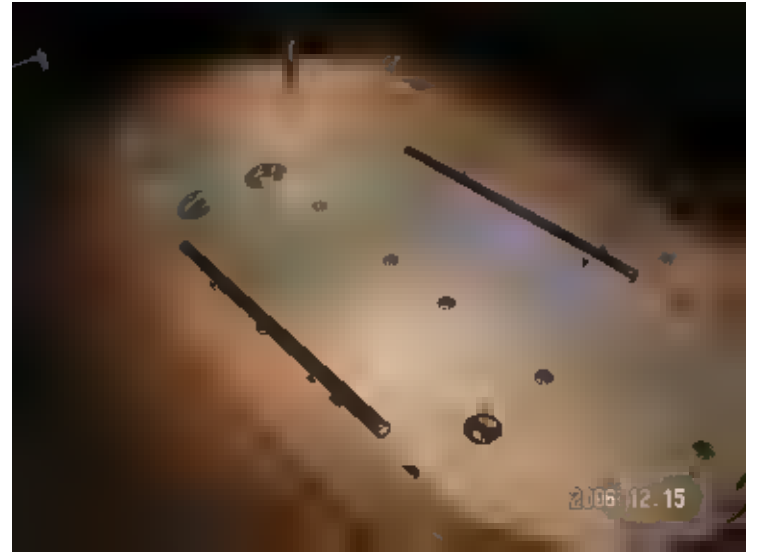

洗澡床



老人洗澡機



泡澡機

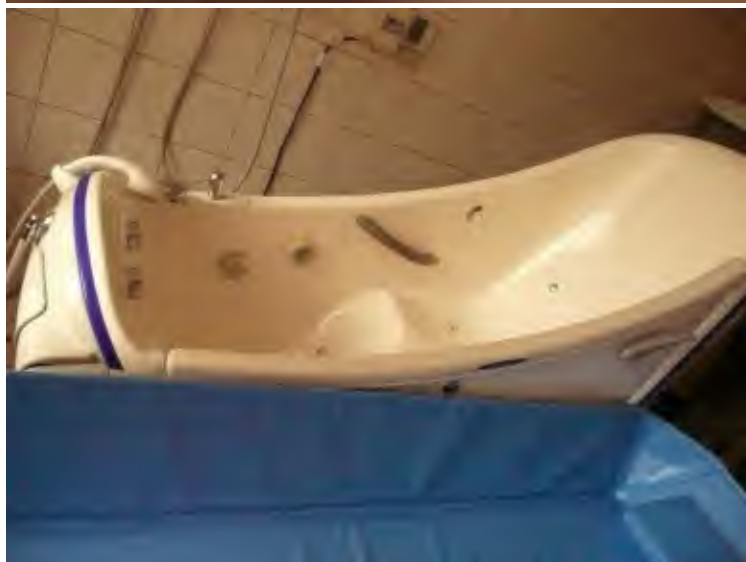

淋浴設備

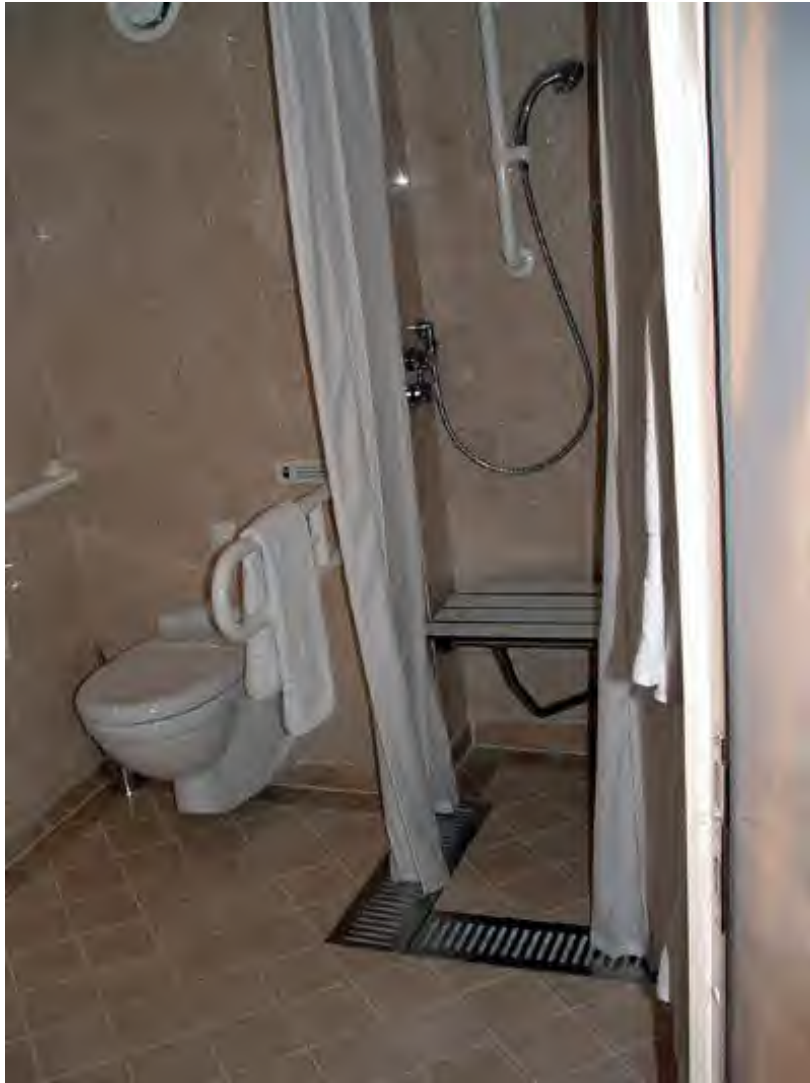

淋浴設備



老人住宅浴池



老人浴廁設施



老人住宅



便器就近床位

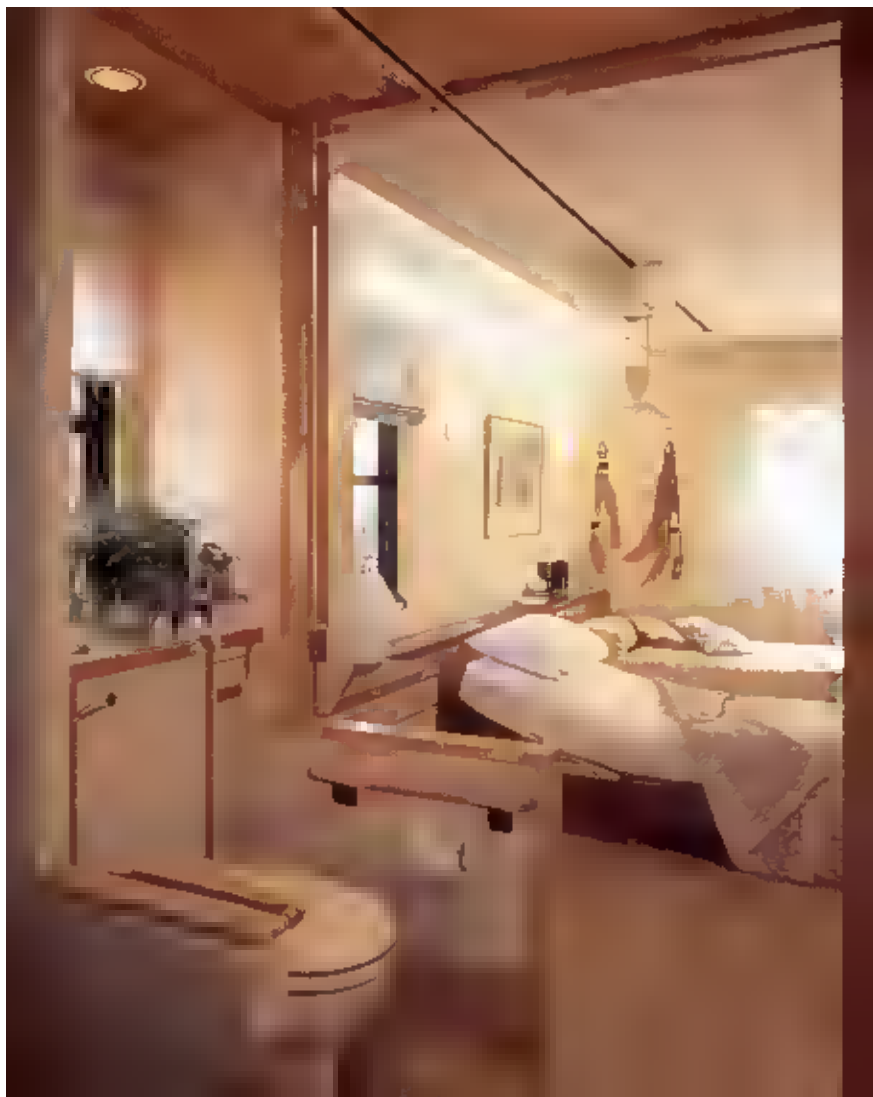

室內空間安排

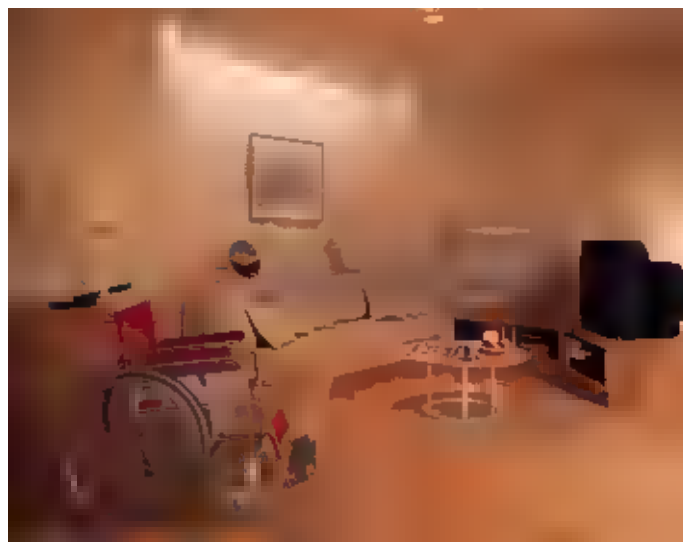
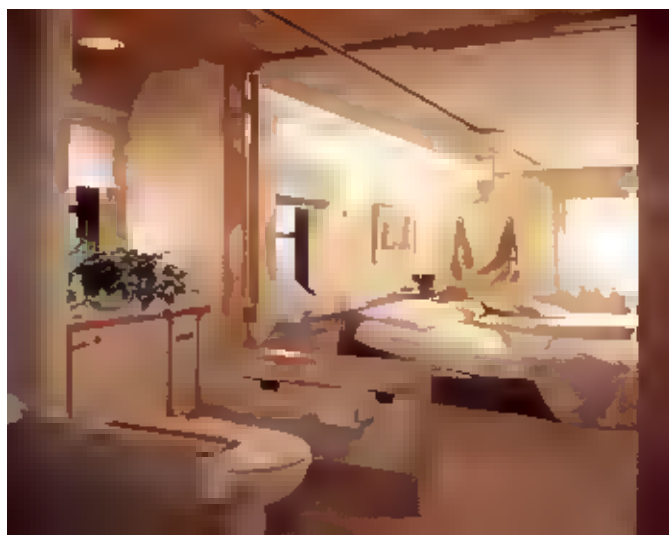

板橋榮民之家

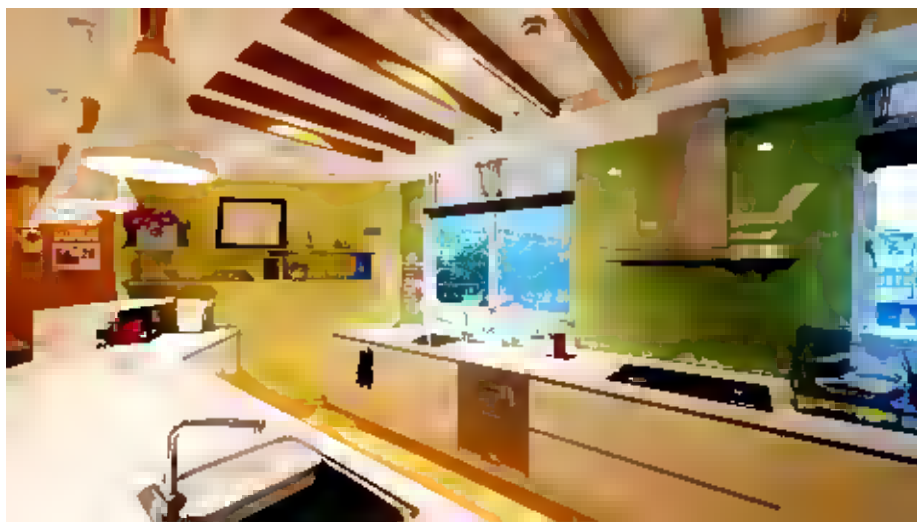
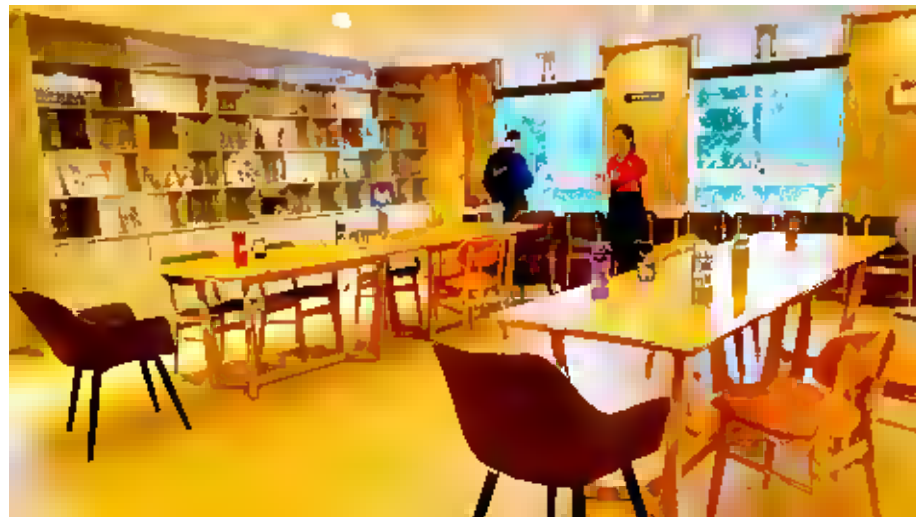

洗面台加設扶手



人工肛門洗滌設施



日本人工肛門者廁所設置



照護床



圖 3-48 行動不便廁所 A 型-設計平面圖



圖 3-50 折疊式活動床使用圖例

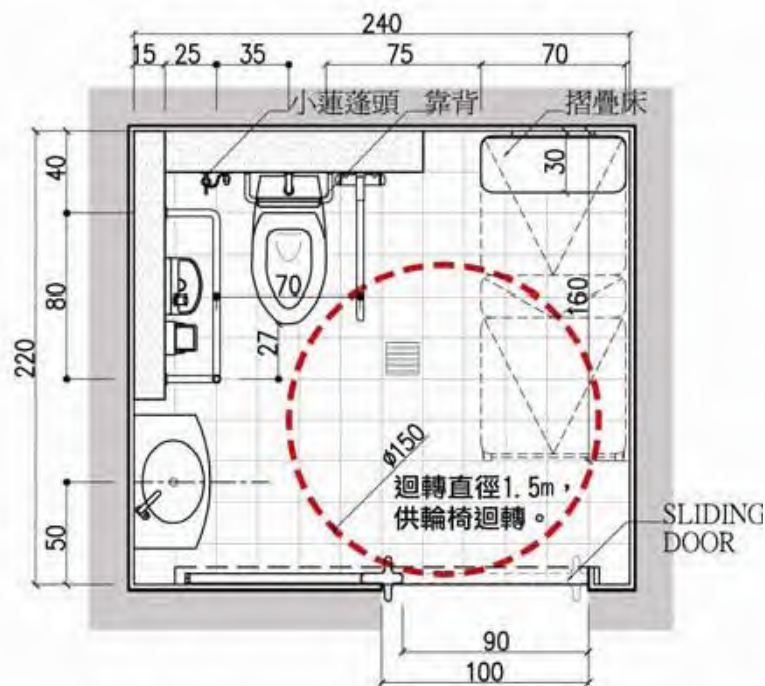

照護床



照護床



收納時



使用時



老人住宅單元

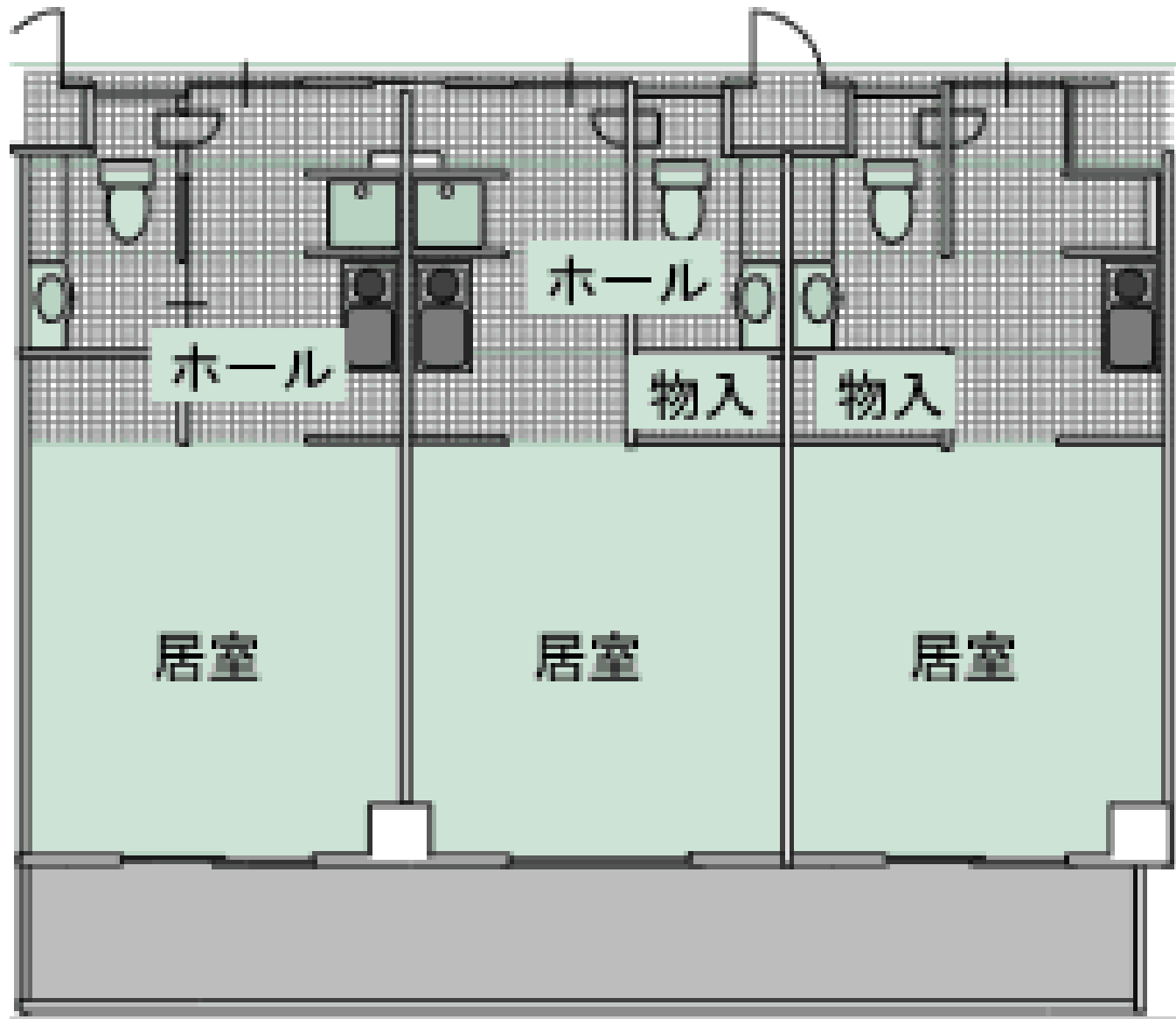

日本滑推門 komats



日本滑推門 komatsu



日本滑推門 komatsu-wall



輕便開啟推轉拉門

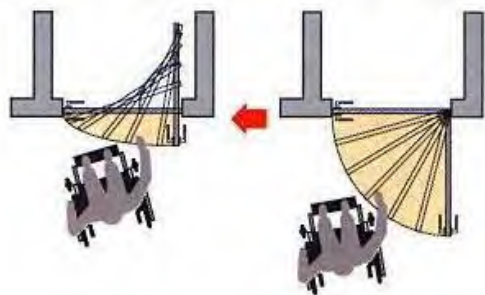

輕便開啟推轉拉門

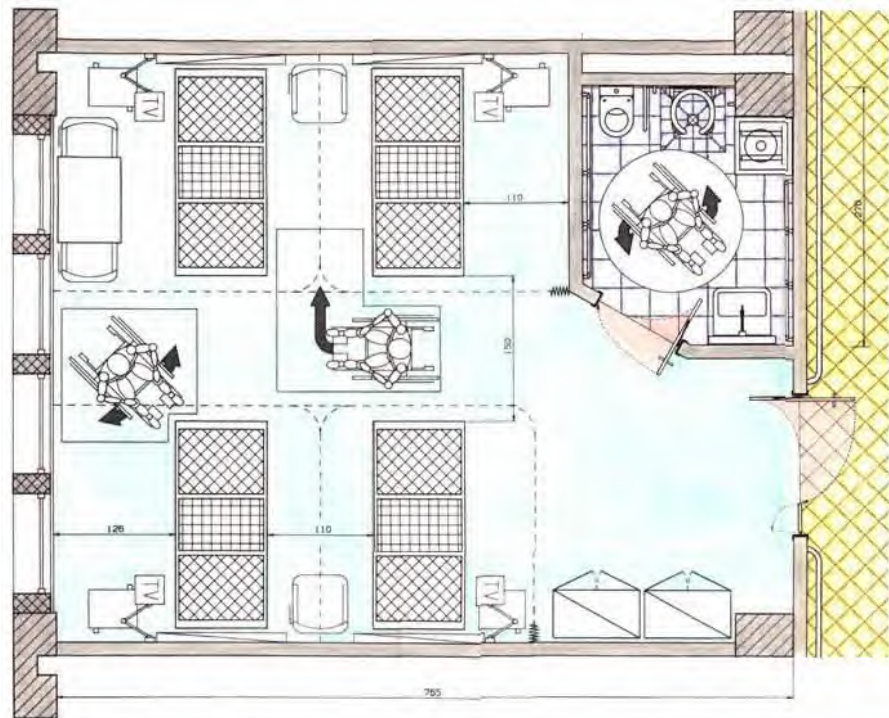
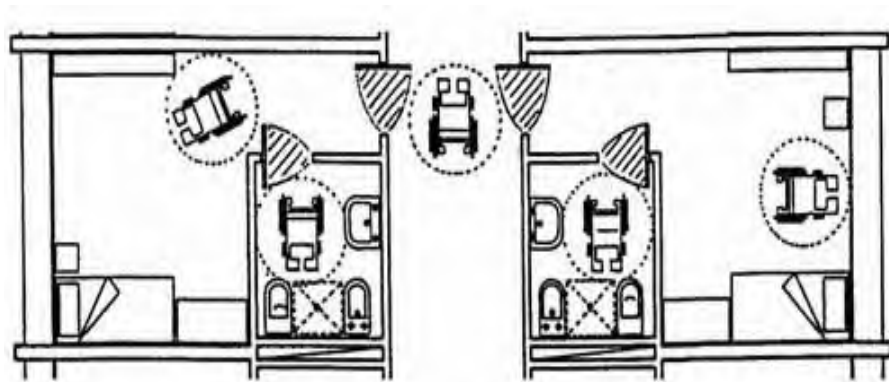

推轉拉門

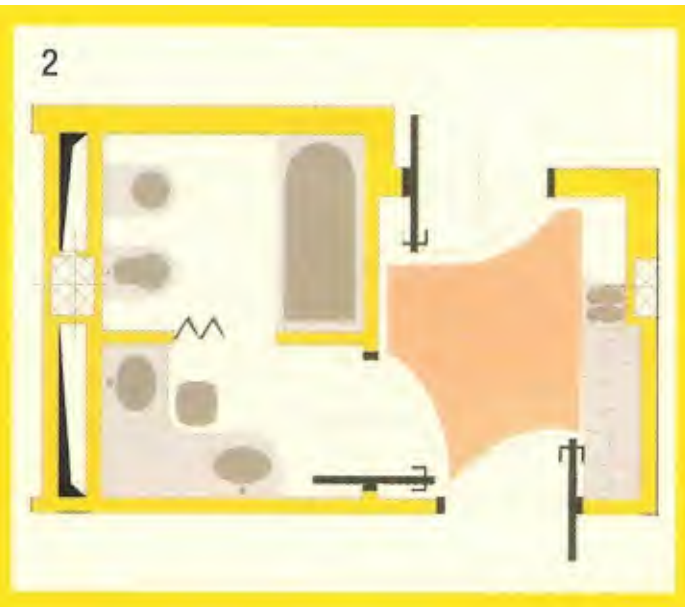
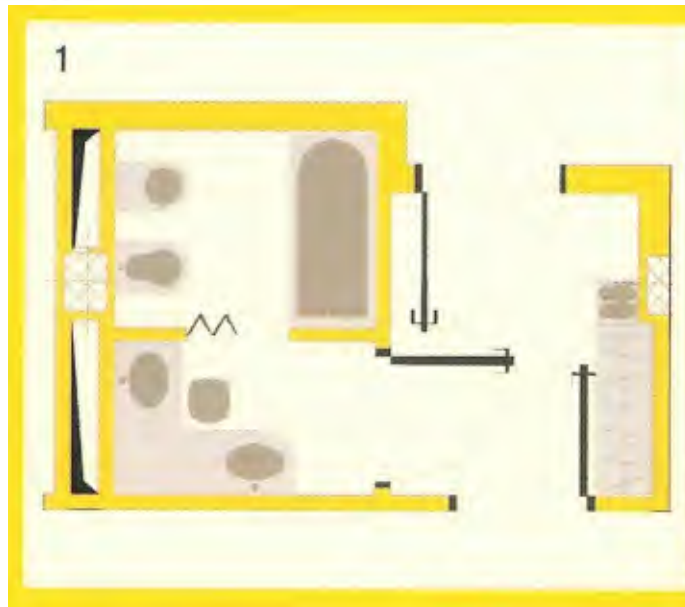
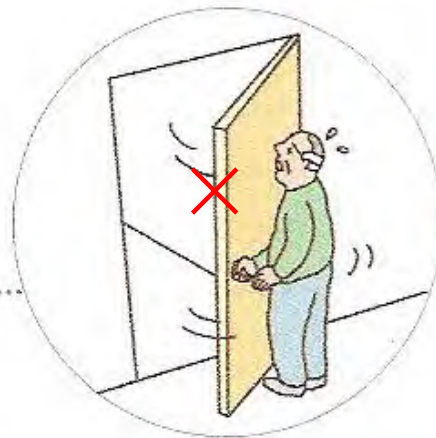
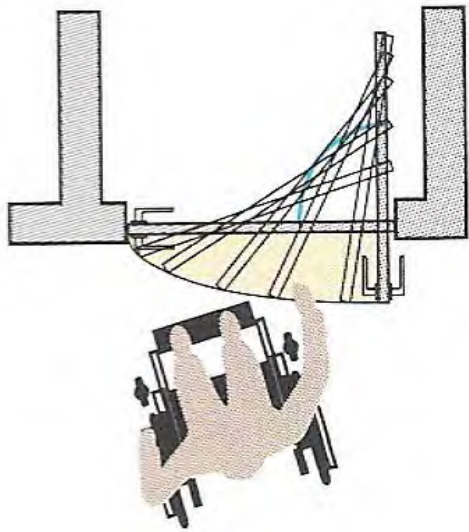

改修前後平面

改修後平面図

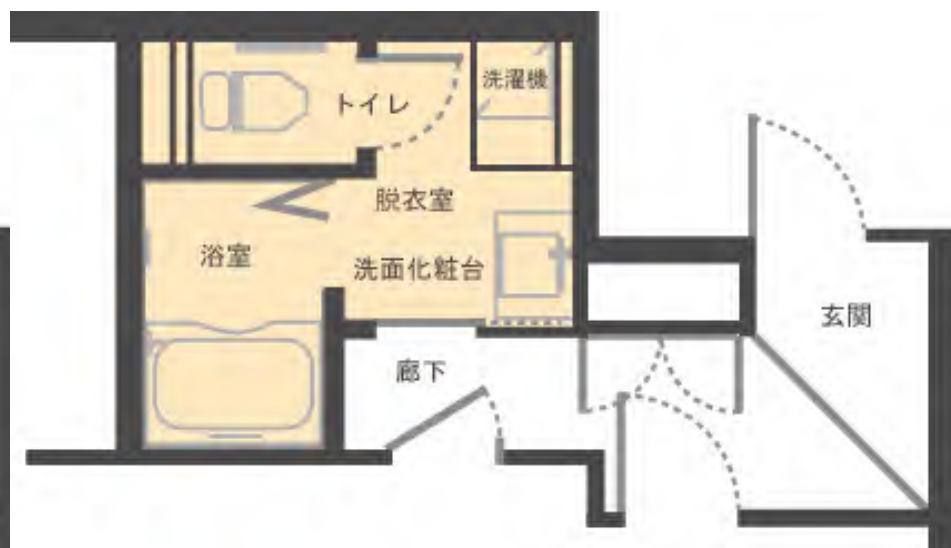
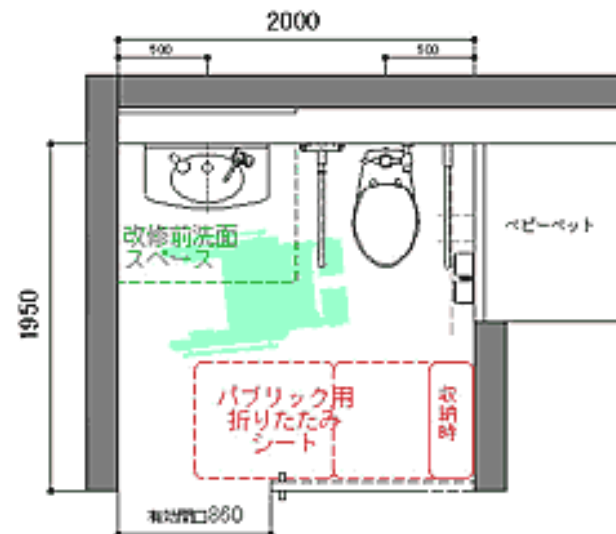
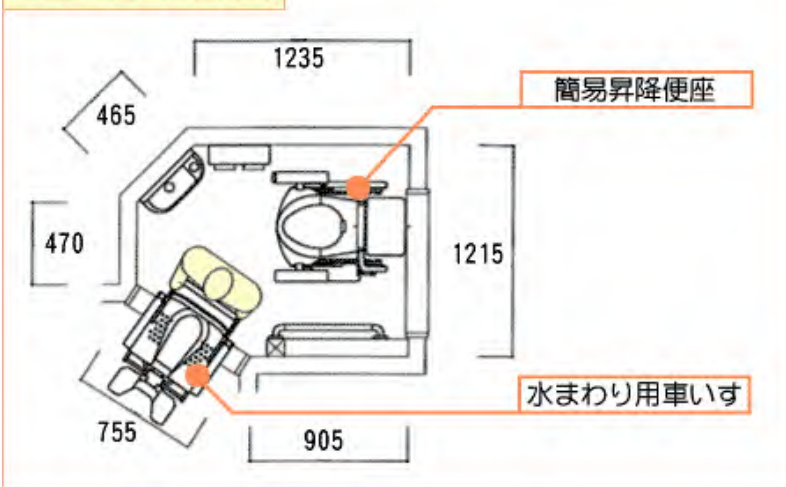

通用建築



輪椅專用席位



休息空間



環境綠化



環境綠化



休息談話空間

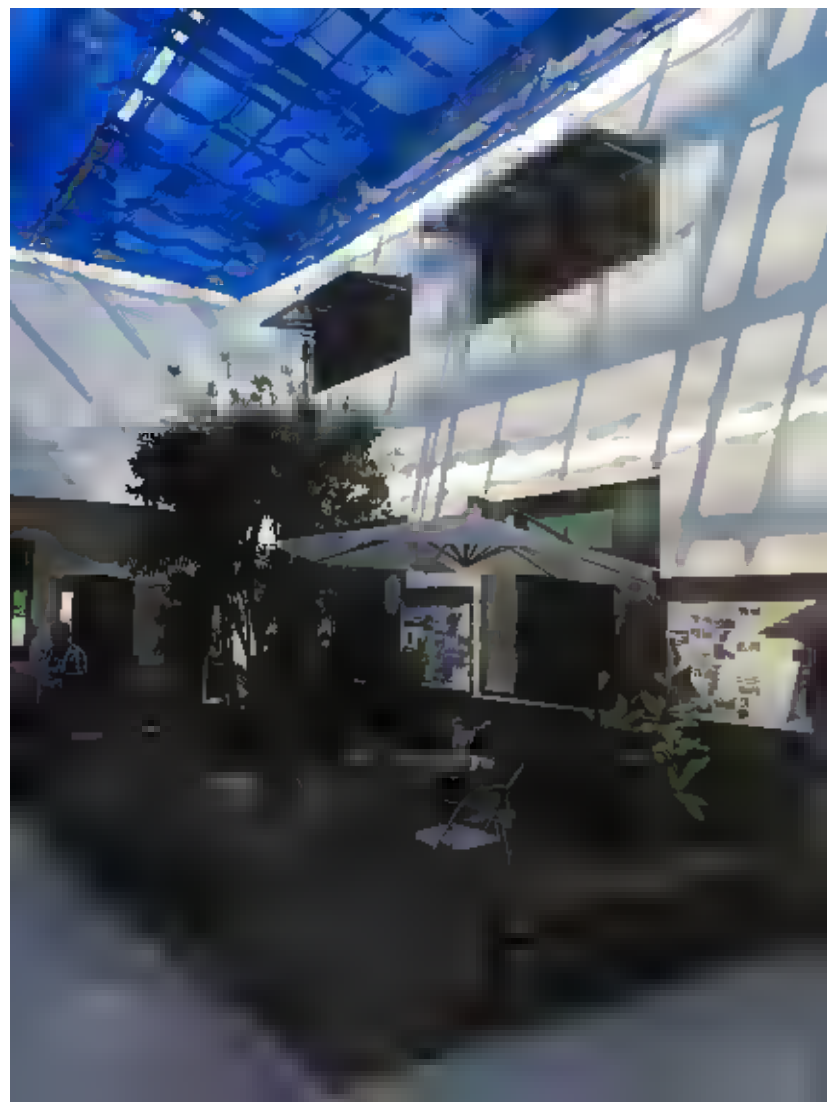

戶外休憩空間



公共服務空間：心靈寄託

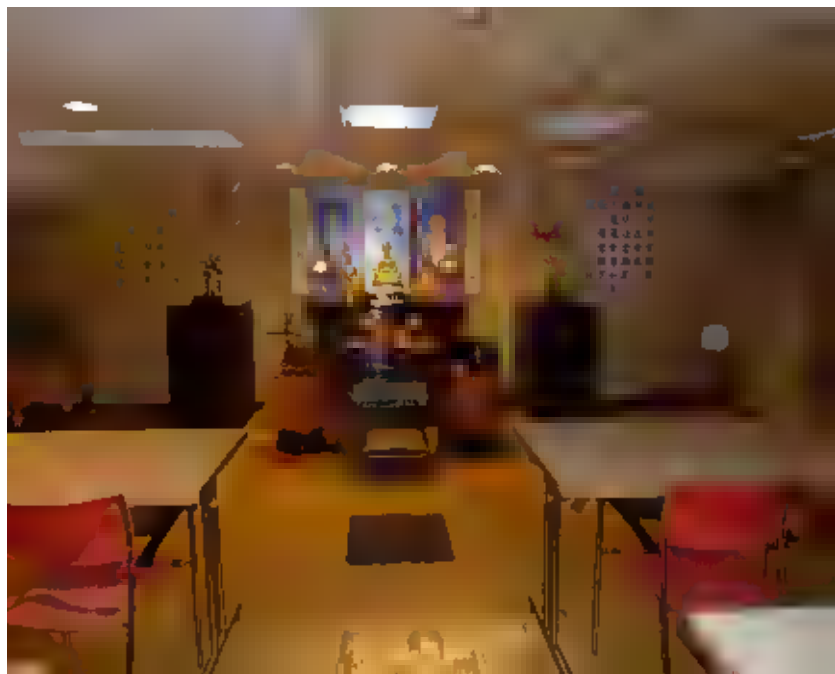

療癒環境的營造



宗教療癒

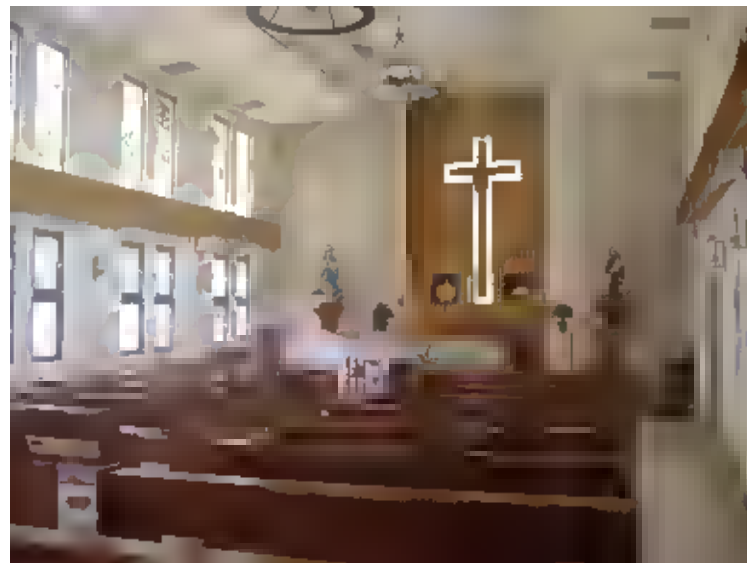

宗教療癒



至少每二戶陽臺間應相連通，陽臺之間
應為容易開關之推開門，以供緊急救援
人員得從陽臺進入救援



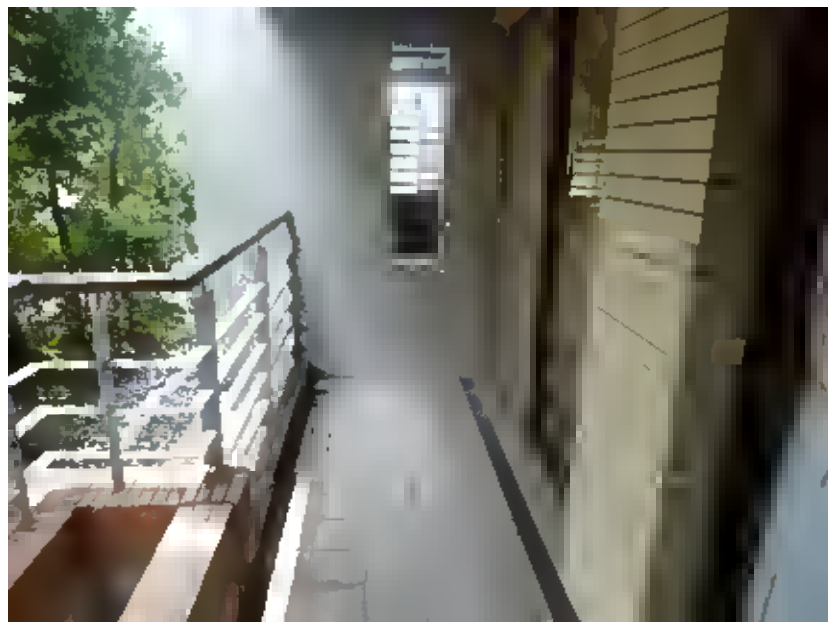
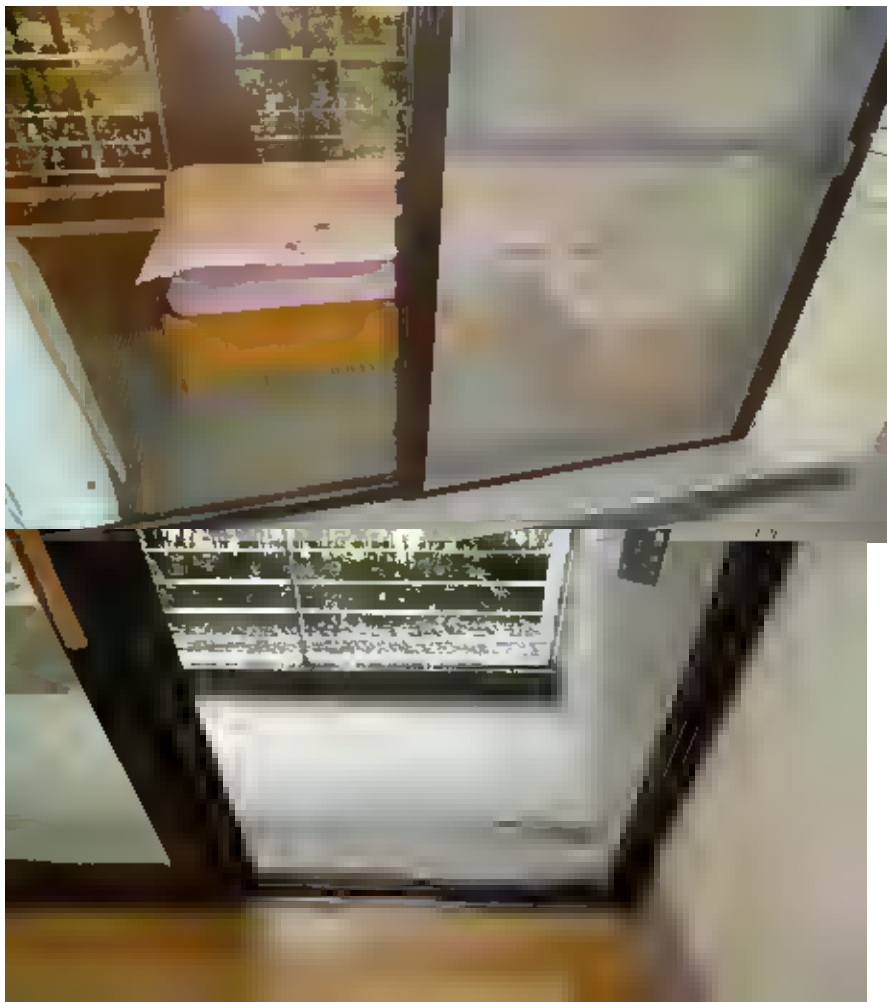

陽臺及平臺 規劃設計原則

輪椅乘坐者臥室

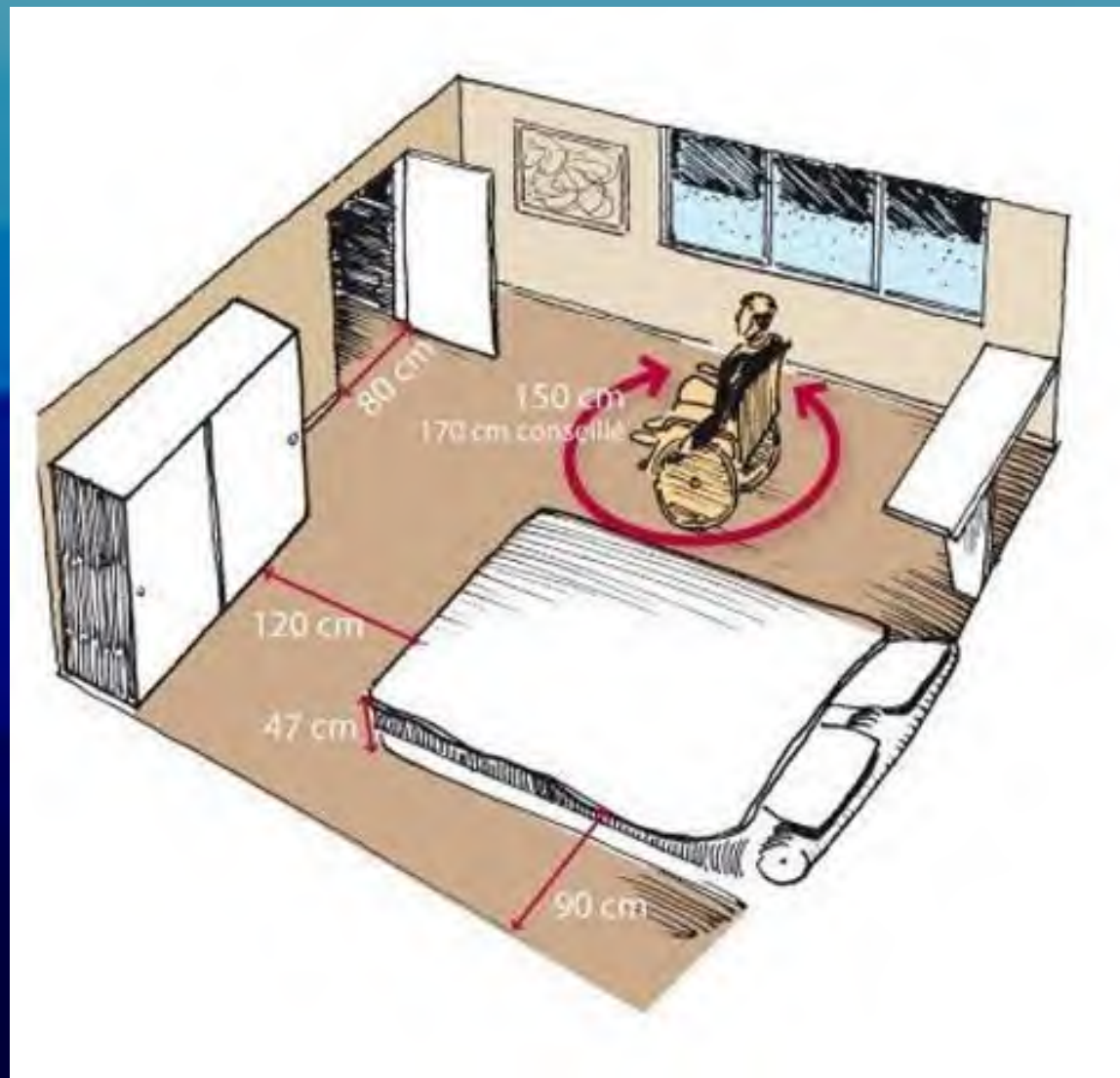

臥室應考慮隔音、容易避難及輪椅使用
空間。

居住單元/雙人床

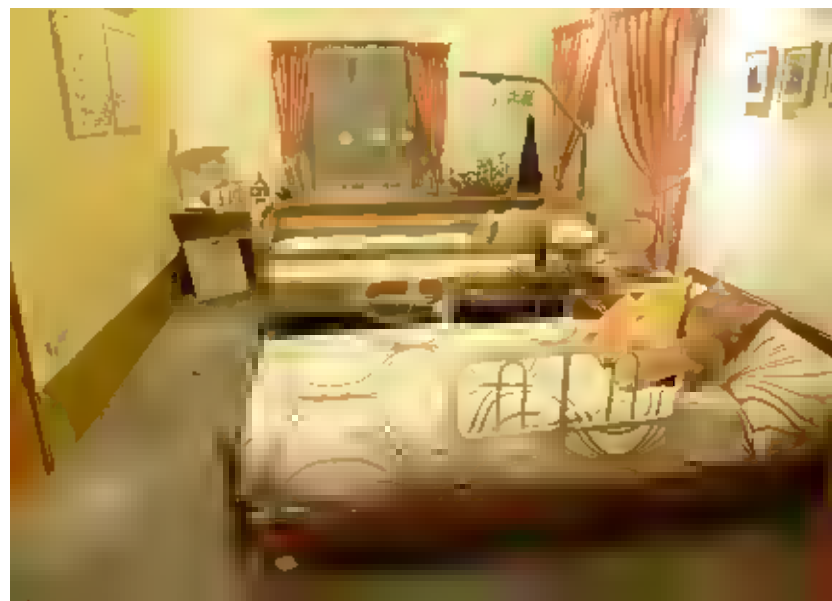
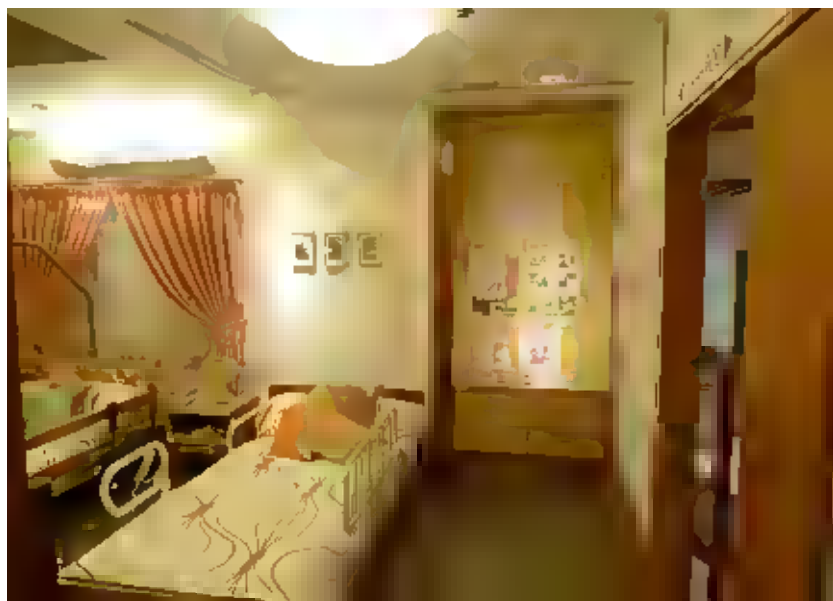

臥室之床位擺設可二面上下床

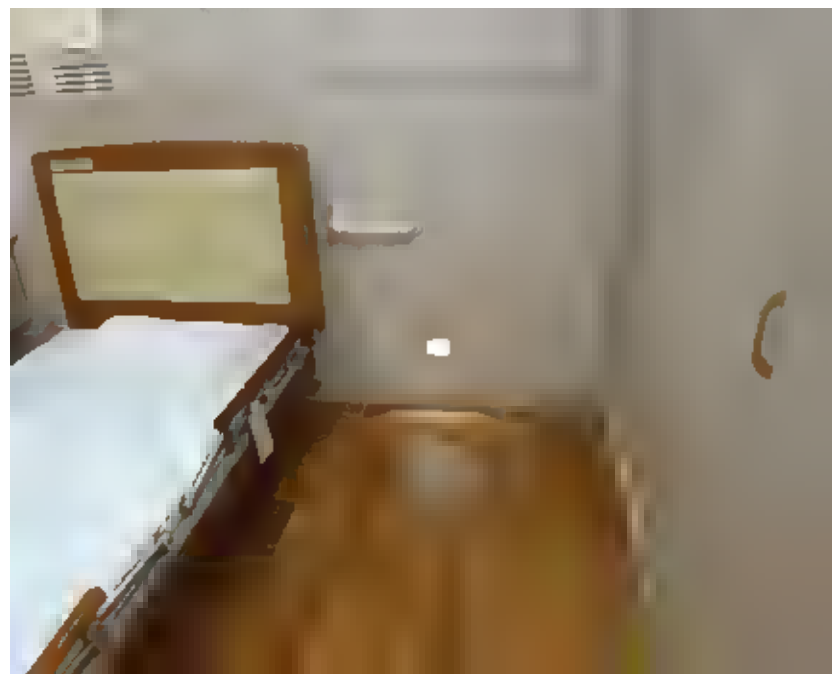

臥室之床位擺設可二面上下床



臥室設置及規劃: 單人、雙人房



廚房料理臺合理之配置，考量身高不同，物品陳列要能取用方便。



廚房、流理台



輪椅族廚房

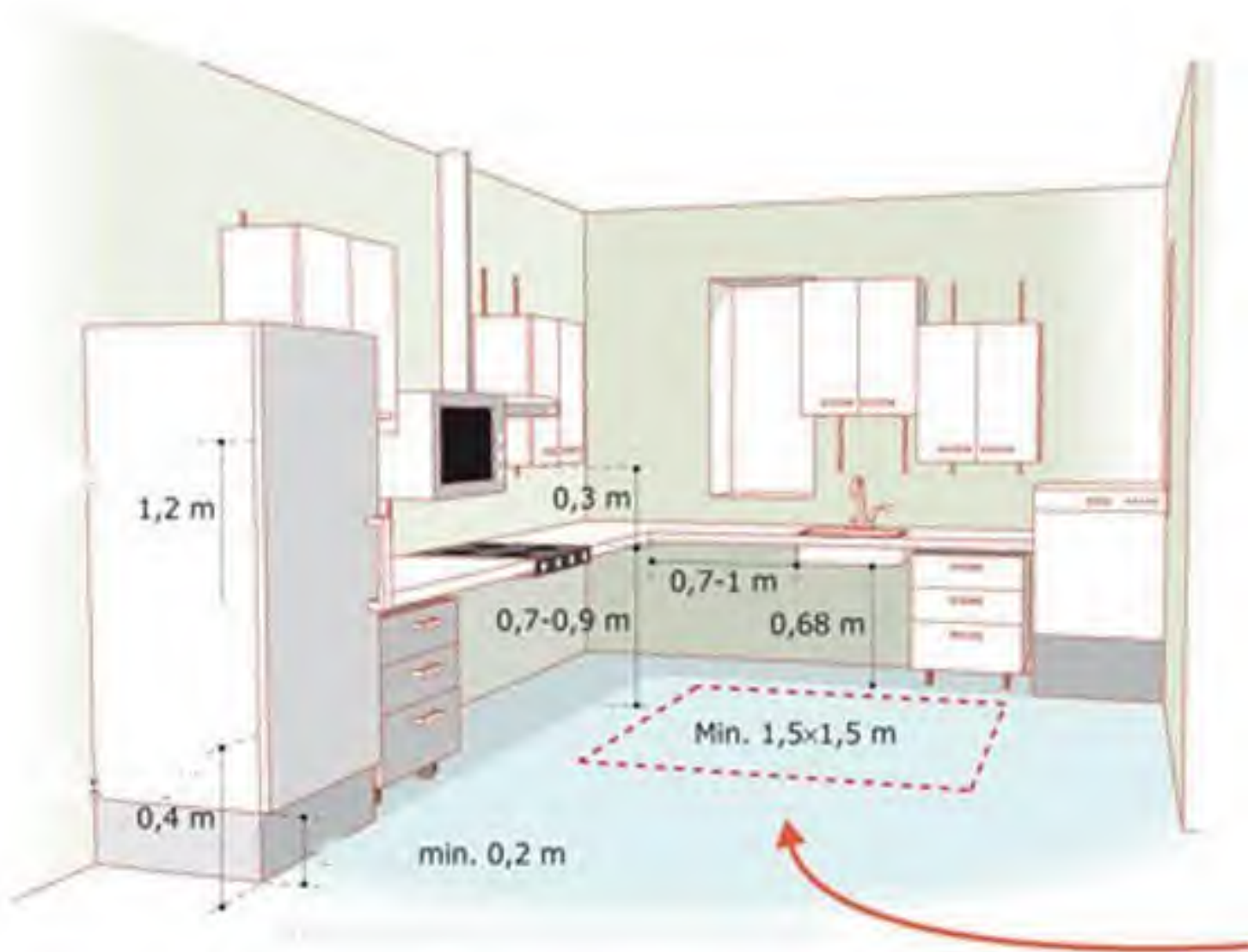

廚房應有的考量



可及廚具

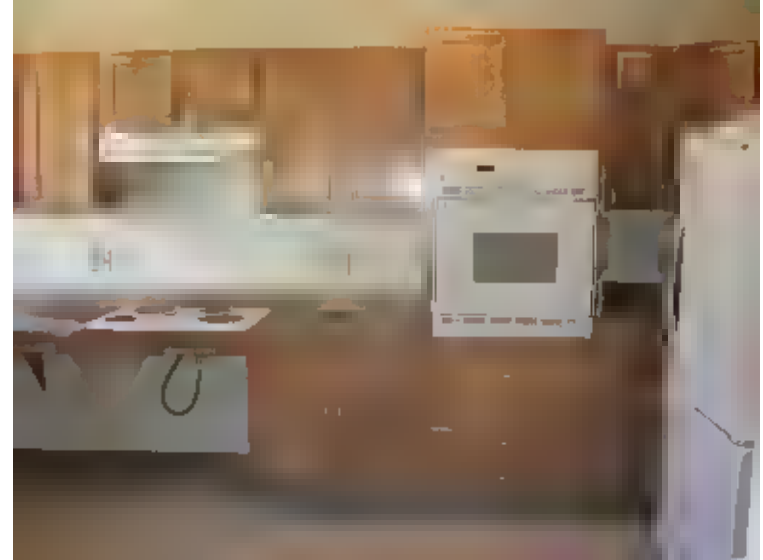

乘輪椅者做家事

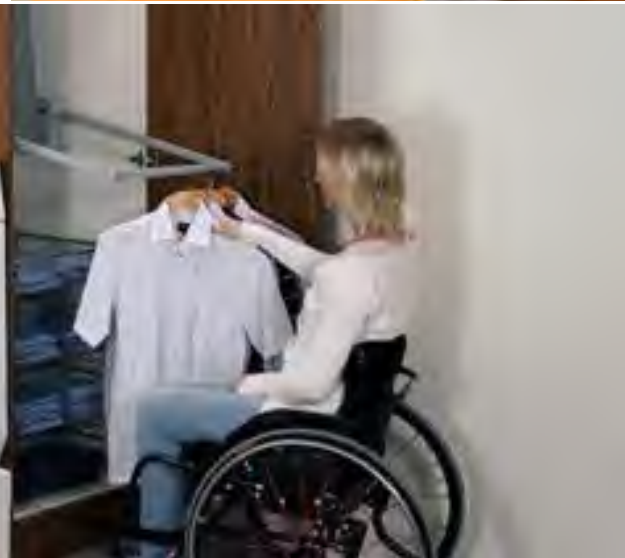

輪椅使用者的廚具



Some refrigerators, such as this one at a retail appliance store in Orlando, are specially designed with removable freezer drawers that slide out, which gives Rossetti full reach; the refrigerator shelves do the same and have adjustable heights. Doors that swing far back are also helpful, Rossetti says.

通用住宅內部



服務管理室應和居住單元呼救系統相連線

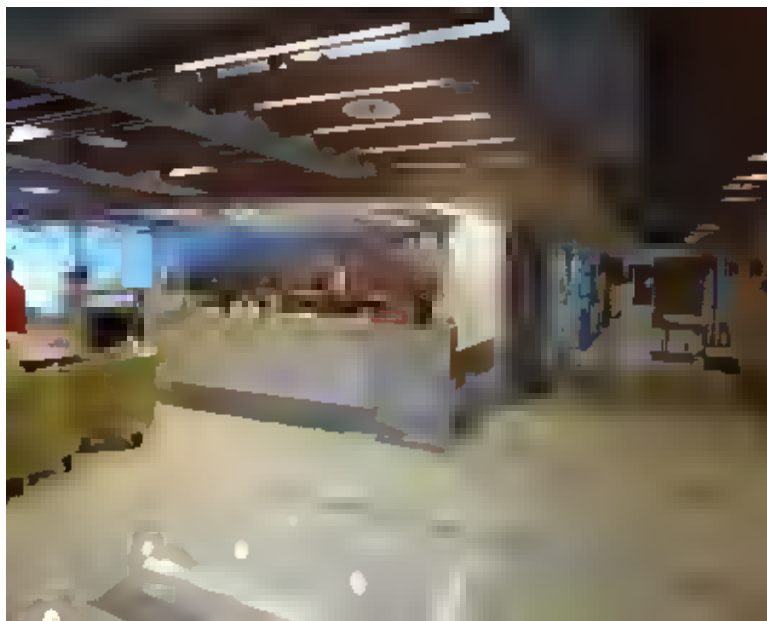

可升降吊櫥



廚房配置及廚具設計原則

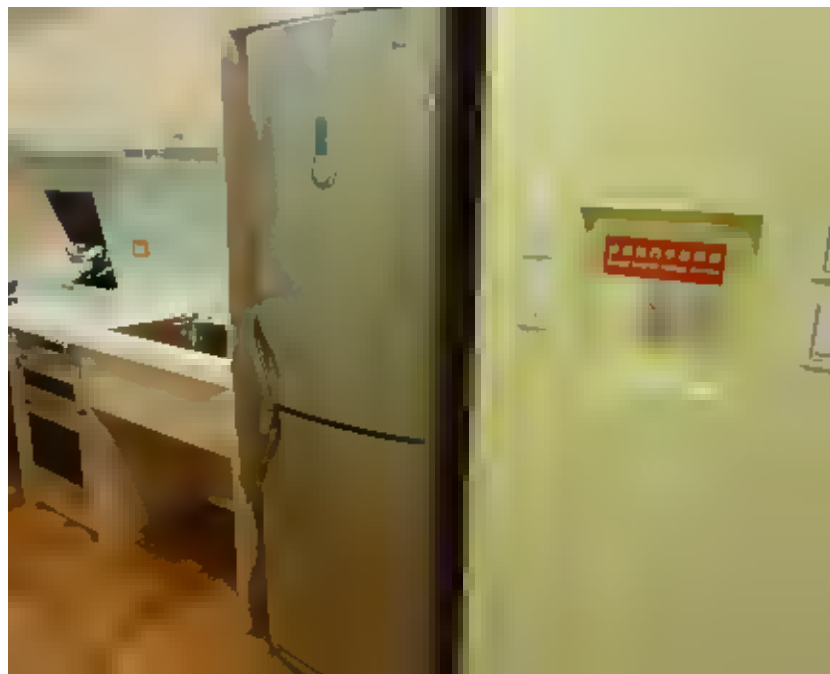

廚房料理臺合理之配置，考量身高不同，物品陳列要能取用方便。



三段油壓式活動廚架

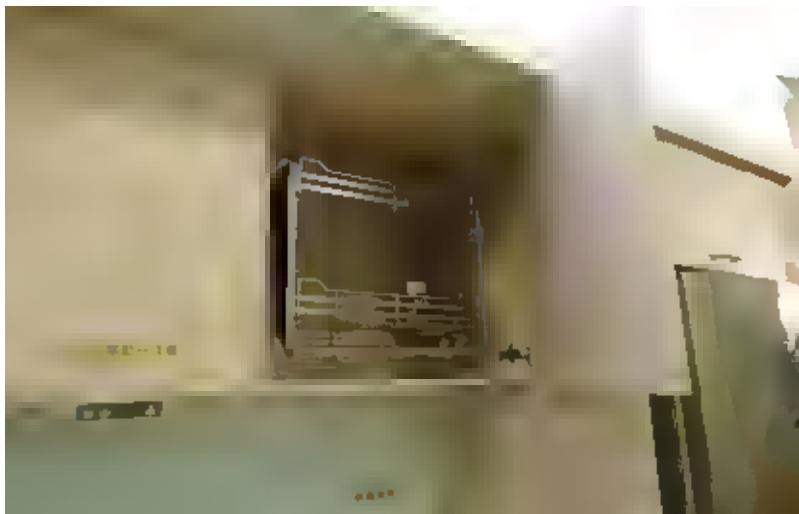

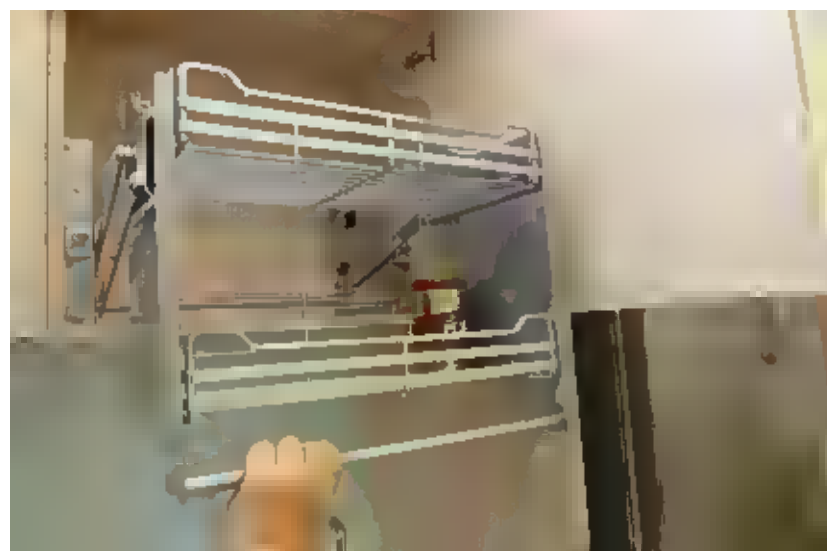
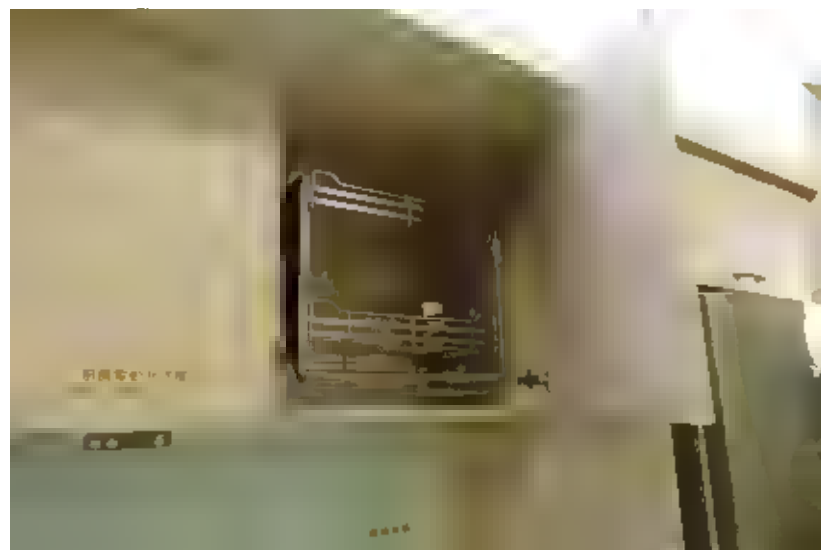

廚房配置及廚具設計原則

廚房配置



廚房料理臺合理之配置，考量身高不同，物品陳列要能取用方便。



廚房配置及廚具設計原則

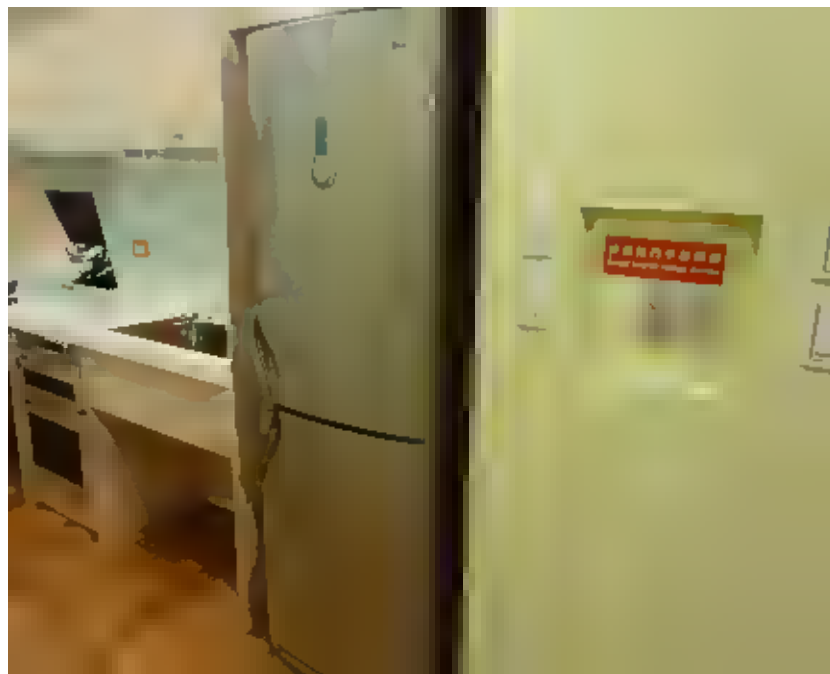

廚房、流理台



洗菜盆水龍頭在左邊更好



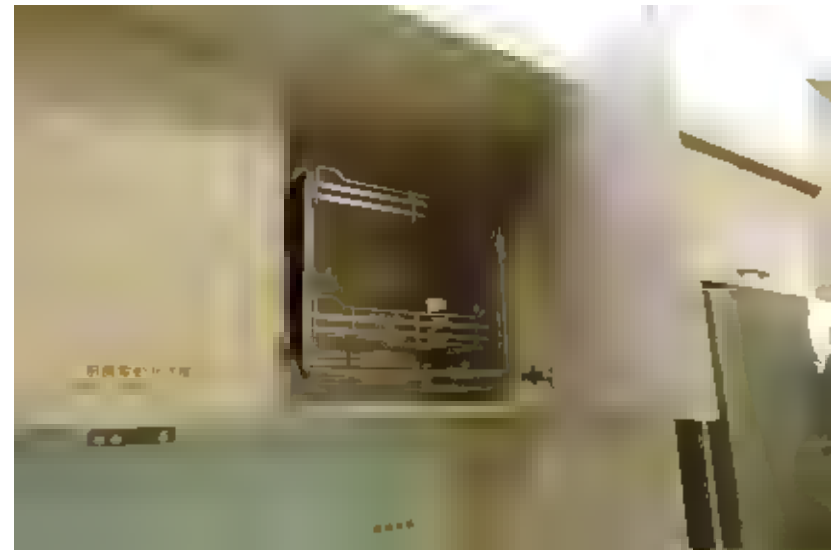

廚房配置及廚具設計原則

爐座中心要離牆側 30cm



餐廳桌椅、用餐具等特色



輪椅族櫥櫃

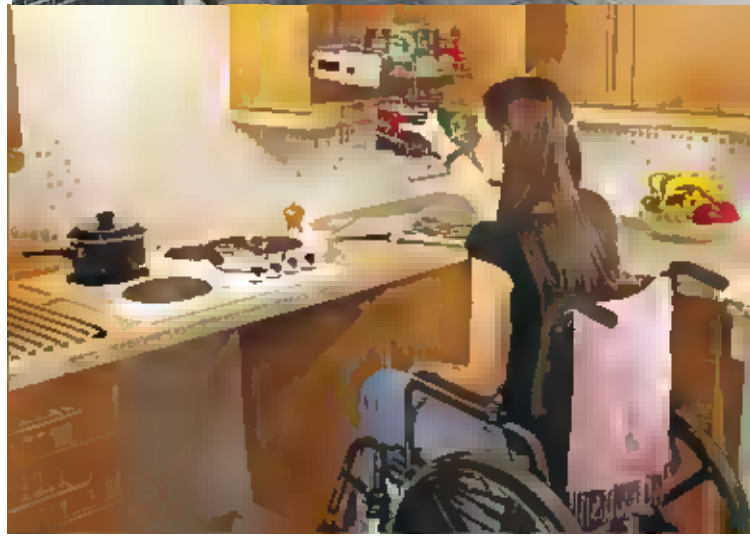

無障礙住宅衣櫥

拉桿尾端離地板120cm以下



衣櫥拉桿尾端離地120cm



衣櫥拉桿



輪椅族衣櫥



逃生滑梯



逃生滑梯



室内止水閥 UD



每戶止水閥

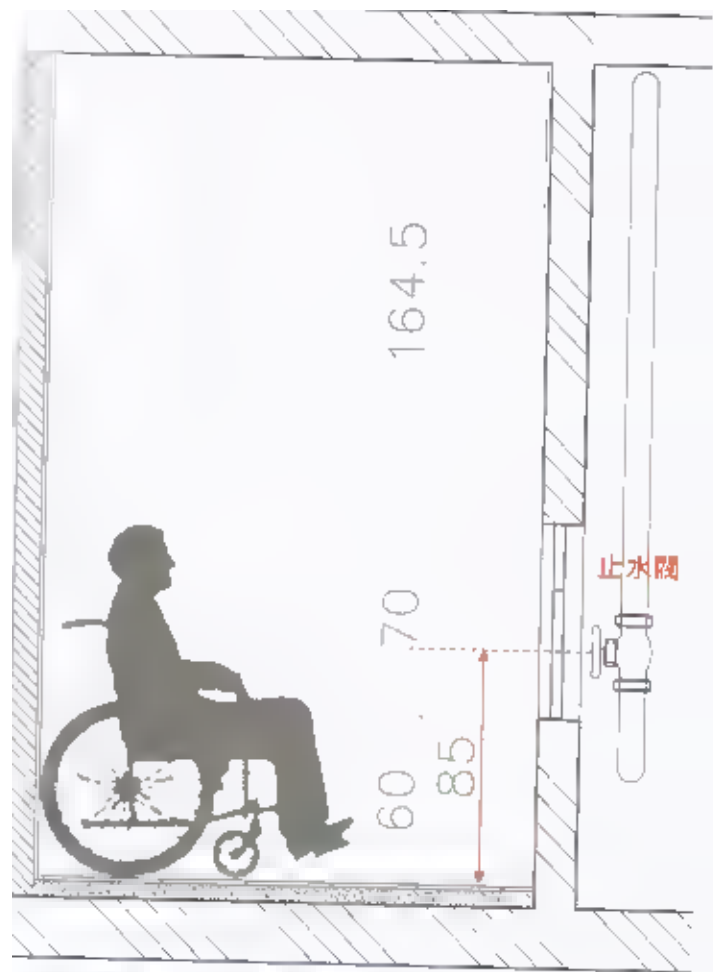
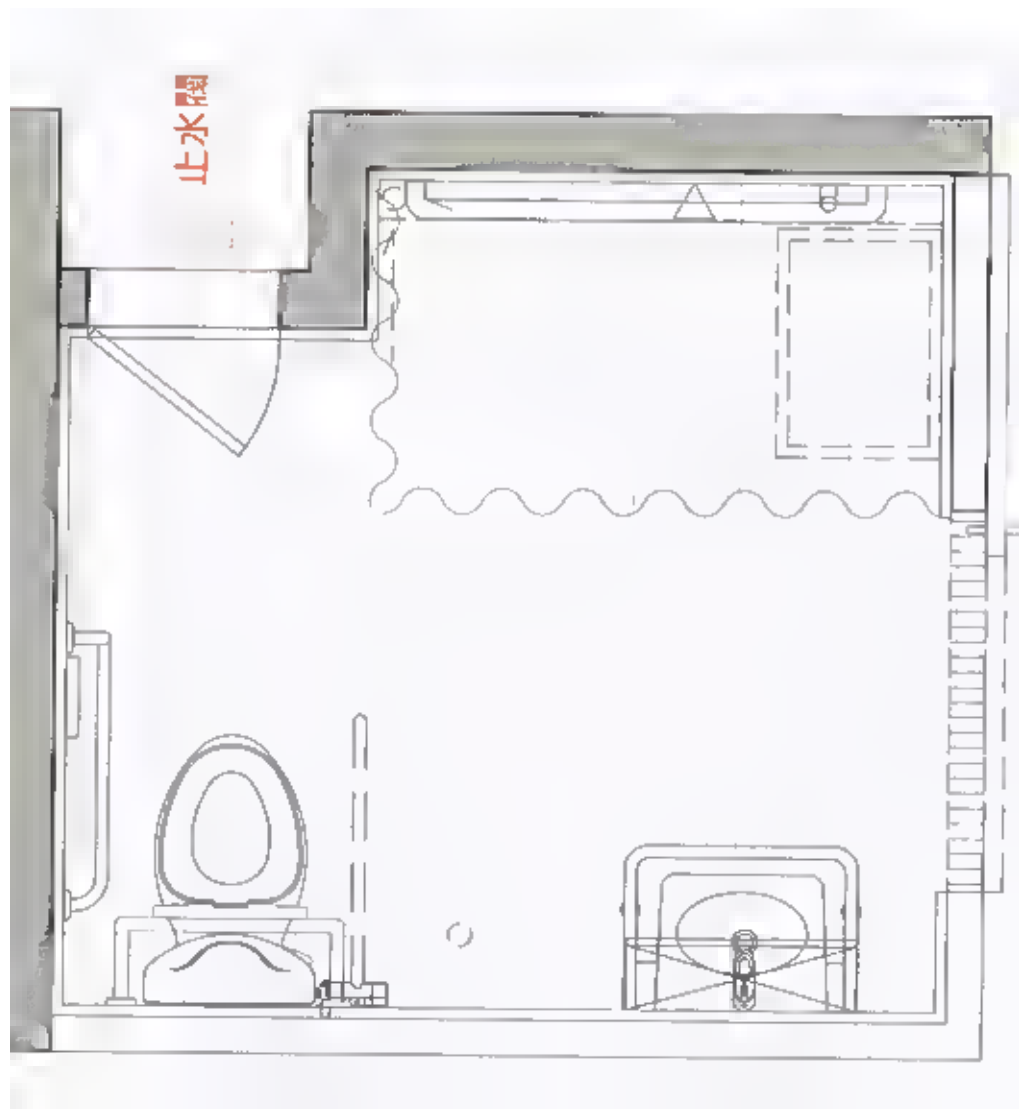

無障礙廁所止水閥位置剖面圖

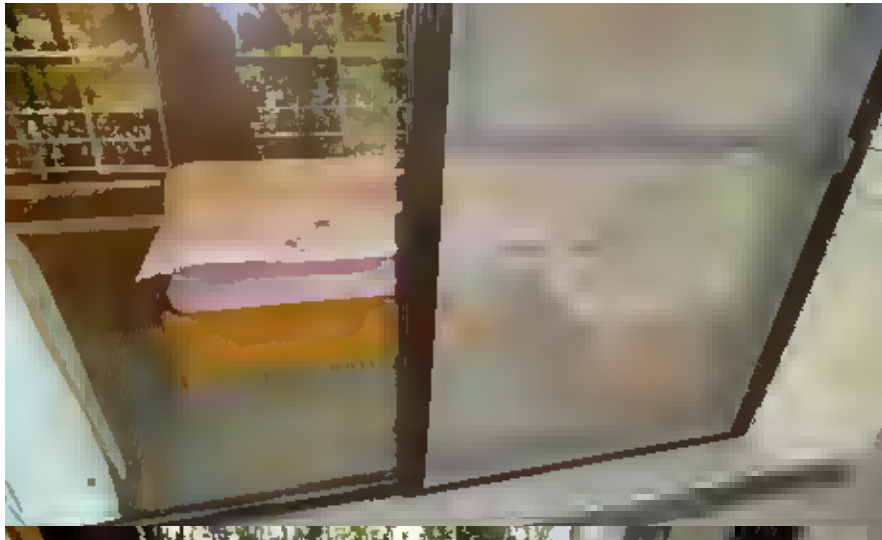

陽臺及平臺 規劃設計原則

陽台落地門排水

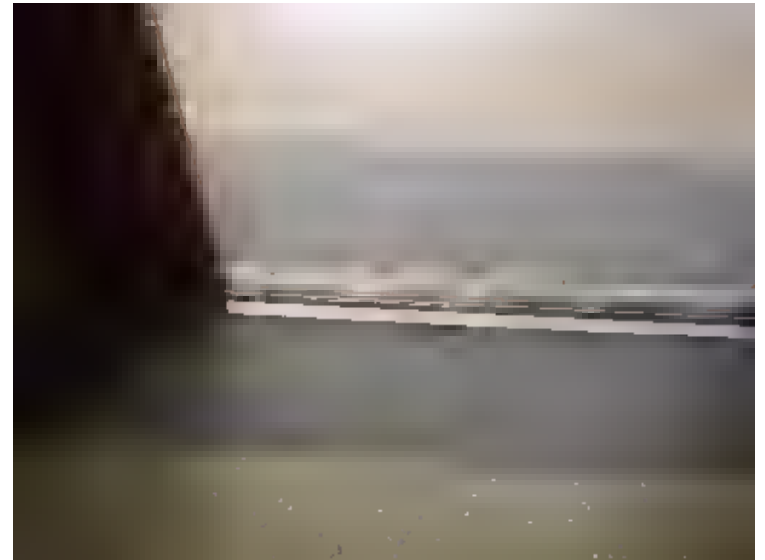
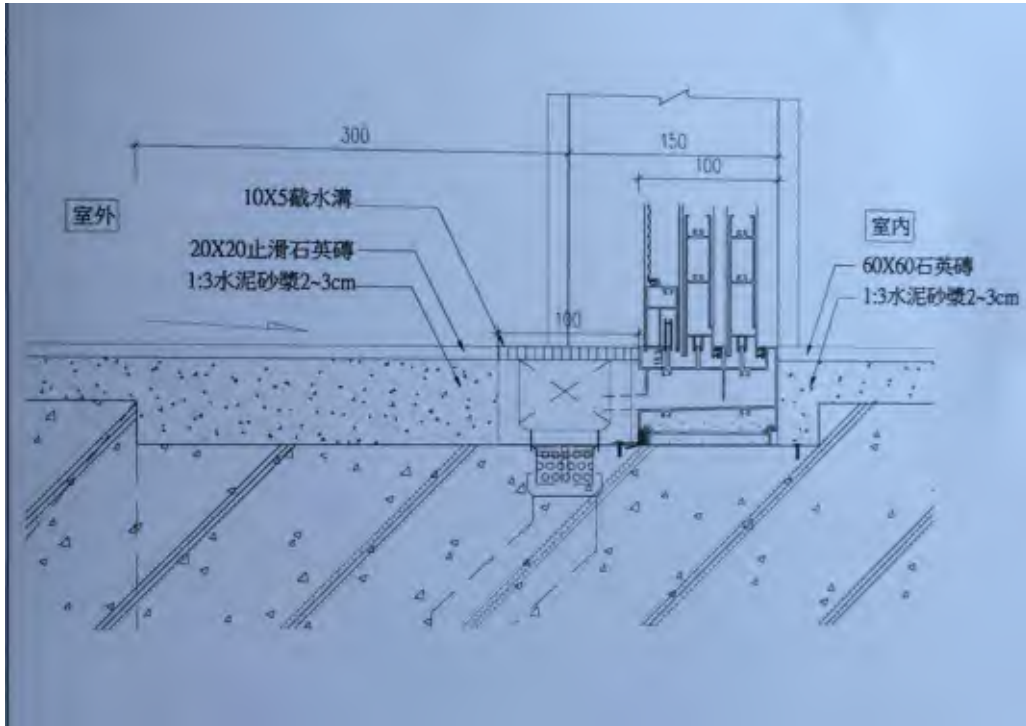

陽台墊高順平

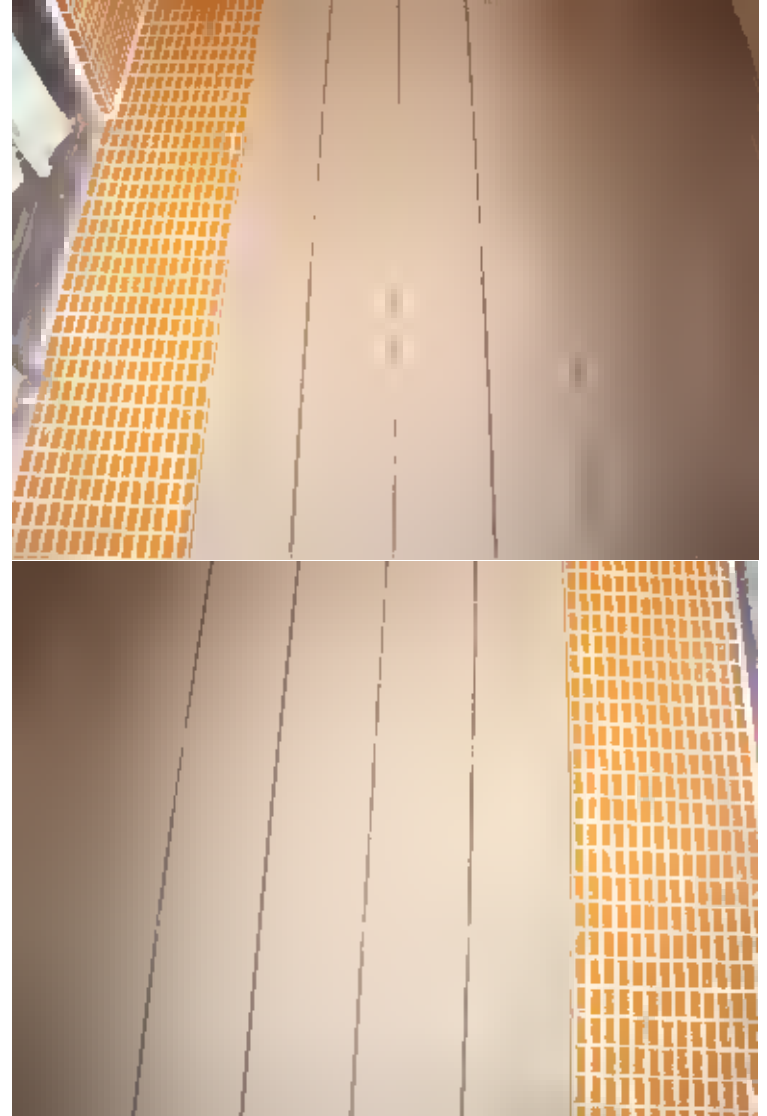
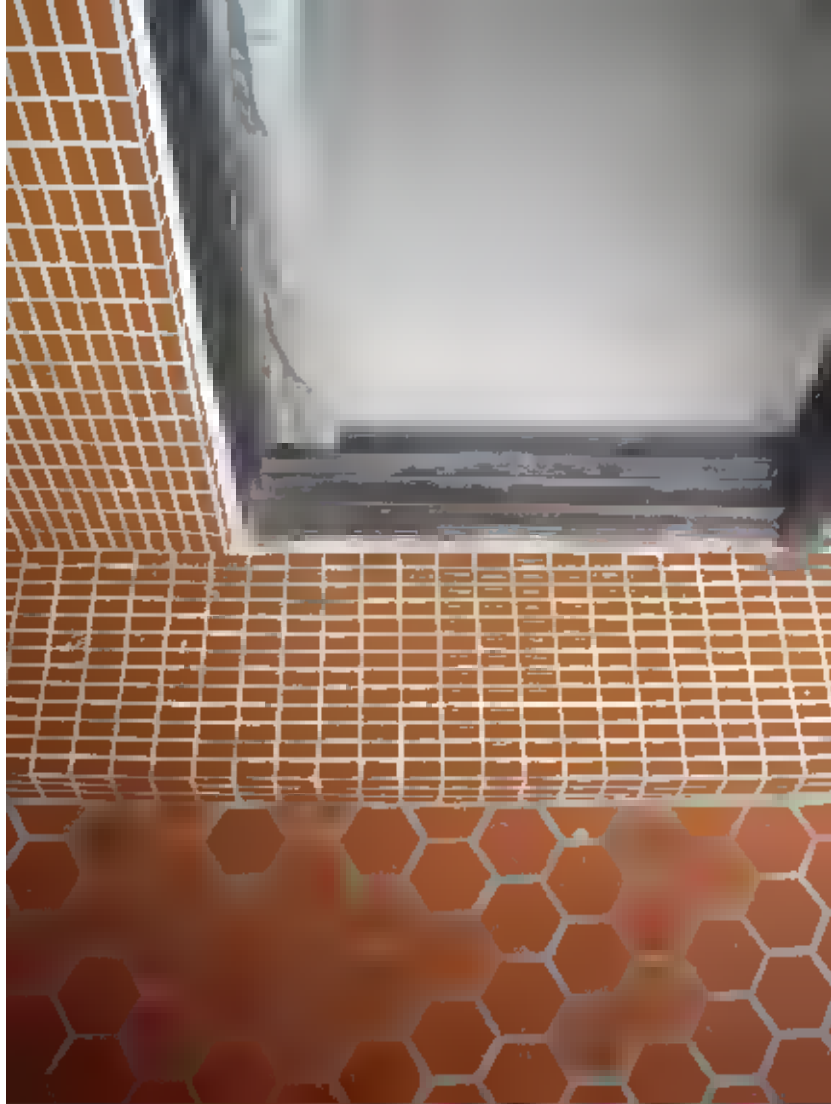

增設垂直扶手



通用設計鑰匙孔UD



UD 產品設計



震動手錶



震動提示器



電話機、電視遙控器數字鍵放大



銀髮族用品

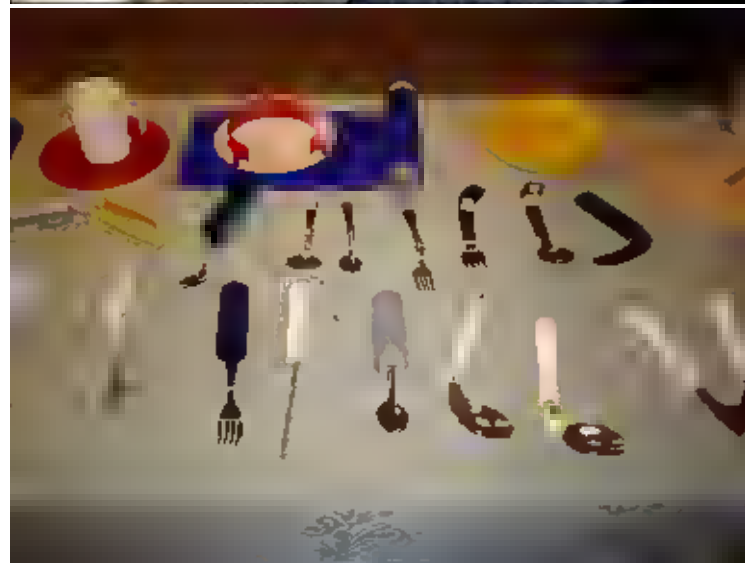

Universal Designed Homes

PLAN # U.D. 2045-03B

CHARLES SCHWAB ARCHITECTS

Colonial w/ Lower Level

American Institute of Architects



Elevation #1 is also interchangeable with plan #U.D. 2045-03A

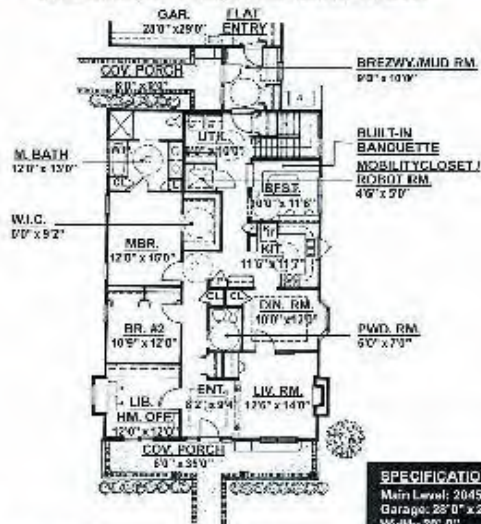

SPECIFICATIONS

Main Level: 2045 Sq. Ft.
 Garage: 28'0" x 29'0"
 Width: 38'-0"
 Depth: 100'-0"

MAIN LEVEL FLOOR PLAN

PRICE TIER: A5

P.O. Box 533, Moline, IL 61266 • WWW.UNIVERSALDESIGNONLINE.COM • 562-359-7524

No warranty is made or implied as to the accuracy of the plans and drawings. All materials are approximate. Refer to contractor's specifications for exact quantities.
 © 2007 Charles Schwab Architects - Printed under International Rights Copyright Protection Act of 1990

CHARLES SCHWAB ARCHITECTS

PLAN # U.D. 1384-03B

American Institute of Architects

Bungalow



SPECIFICATIONS

1334 Sq. Ft. Fin. Area
 Width: 34'-0"
 Depth: 64'-0"
 Driv Garage: 28'0" x 29'0"

FLOOR PLAN

PRICE TIER: A2

P.O. Box 533, Moline, IL 61266 • WWW.UNIVERSALDESIGNONLINE.COM • 562-359-7524

No warranty is made or implied as to the accuracy of the plans and drawings. All materials are approximate. Refer to contractor's specifications for exact quantities.
 © 2007 Charles Schwab Architects - Printed under International Rights Copyright Protection Act of 1990

UNIVERSAL DESIGNED SMART HOMES FOR THE 21ST CENTURY

UNIVERSAL DESIGNED SMART HOMES FOR THE 21ST CENTURY



通用住宅



通用住宅

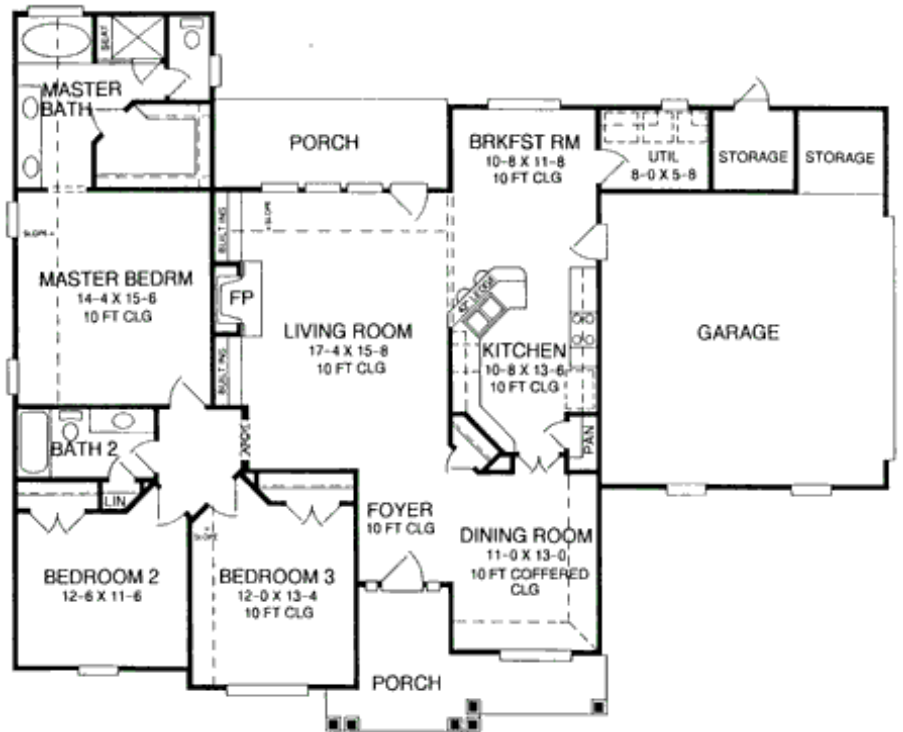

通用住宅

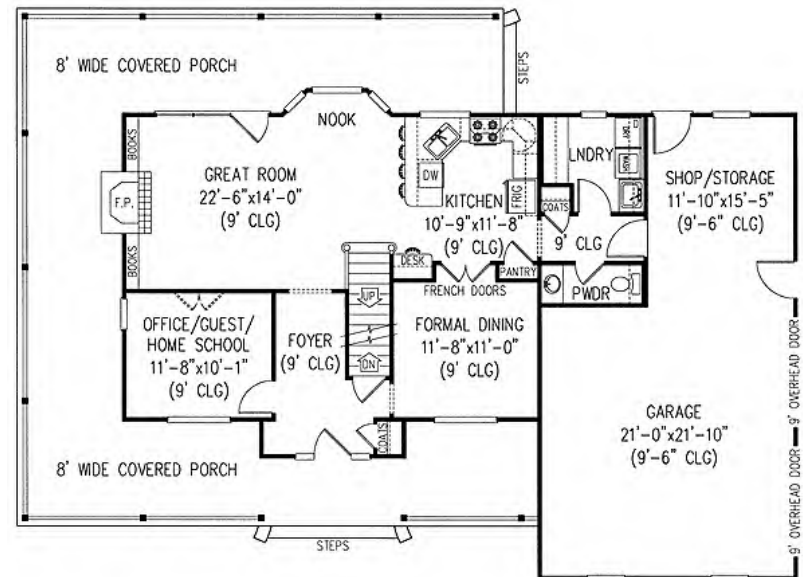
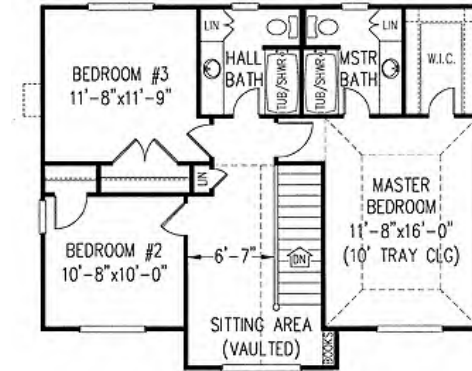

通用住宅

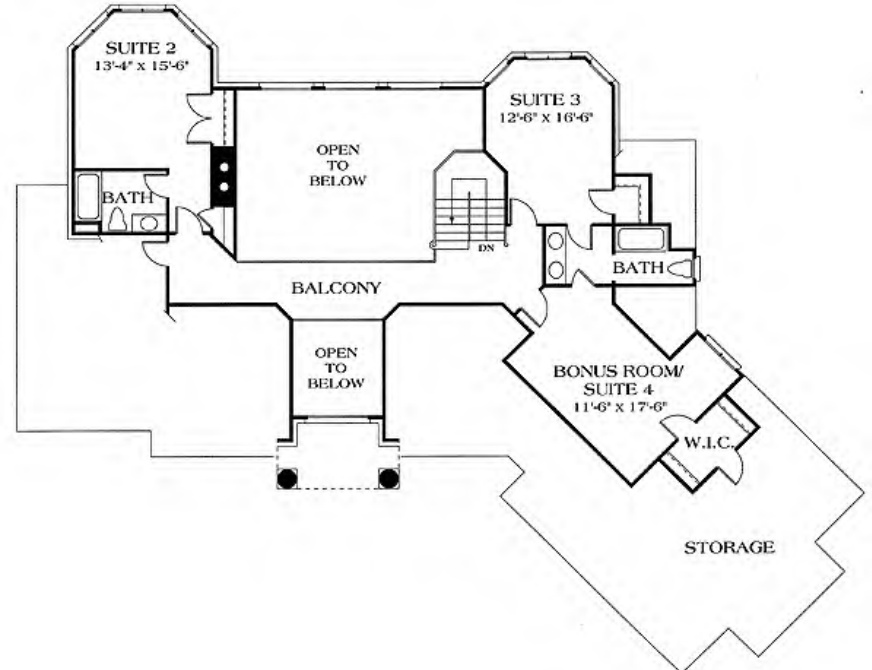
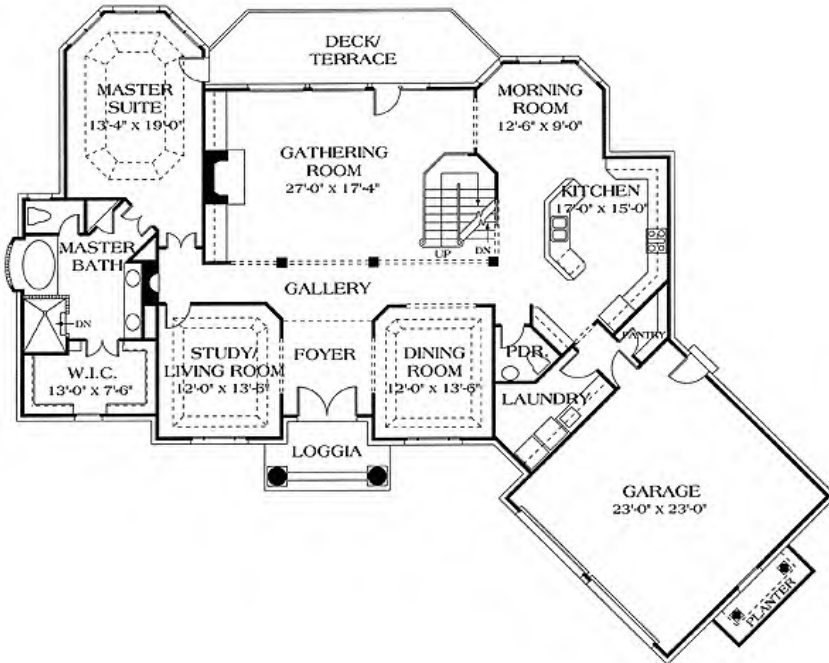

通用住宅

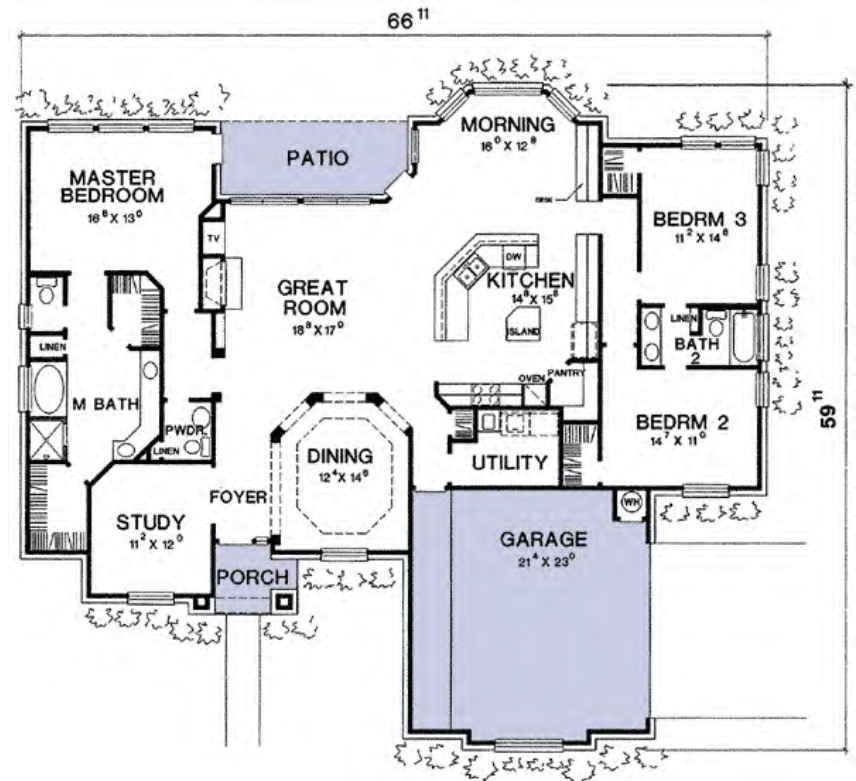

通用住宅

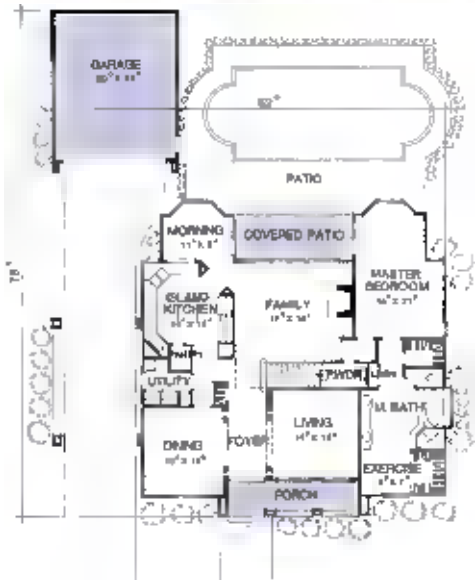

通用住宅

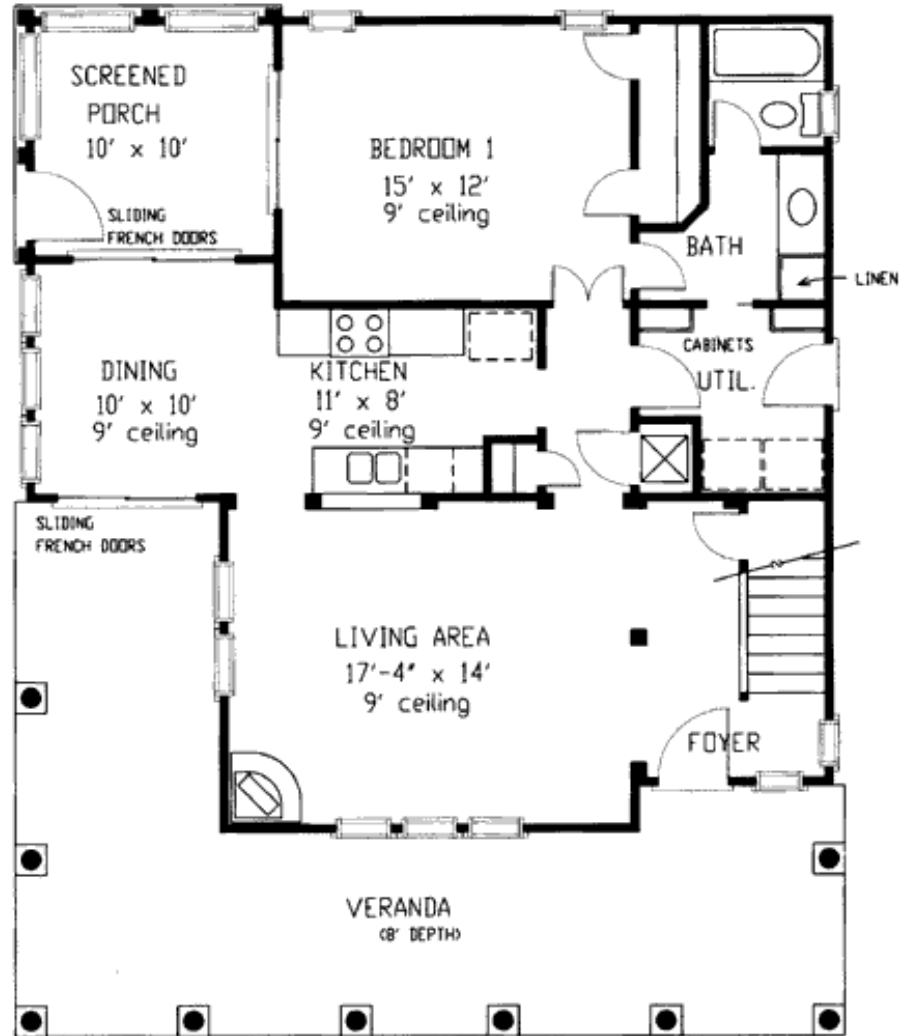
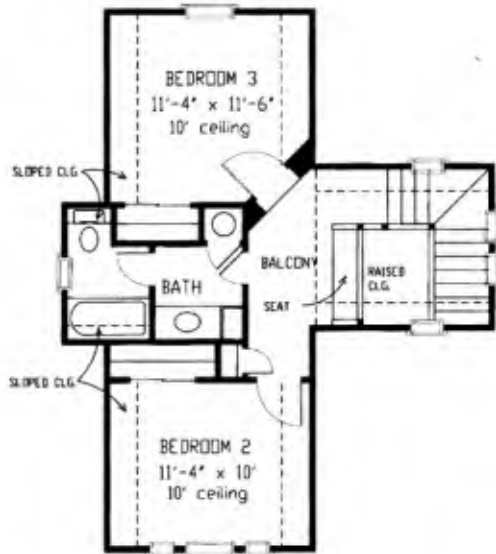

通用住宅

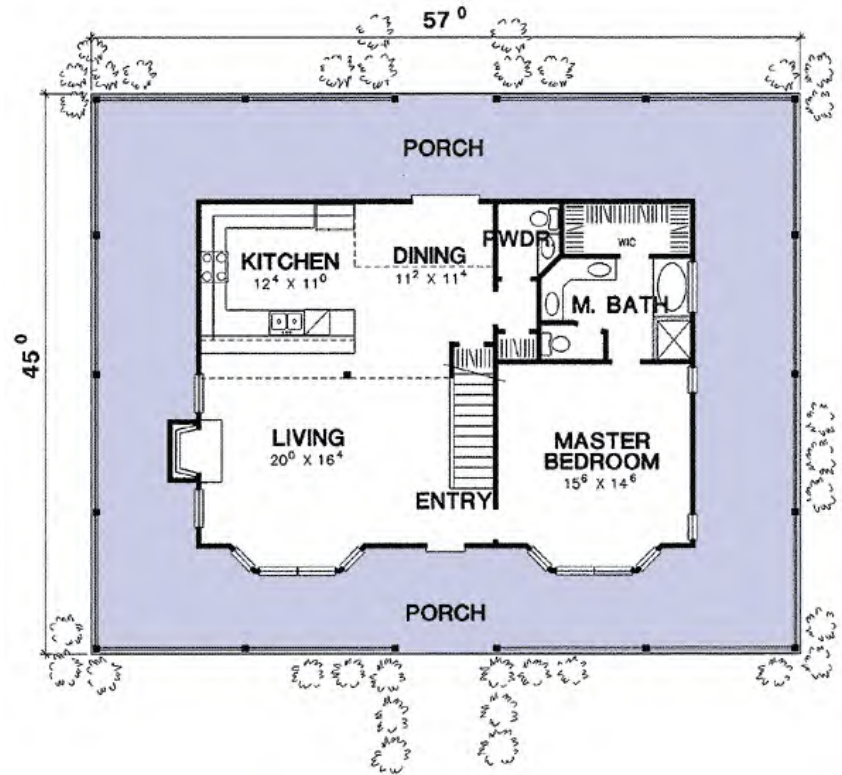

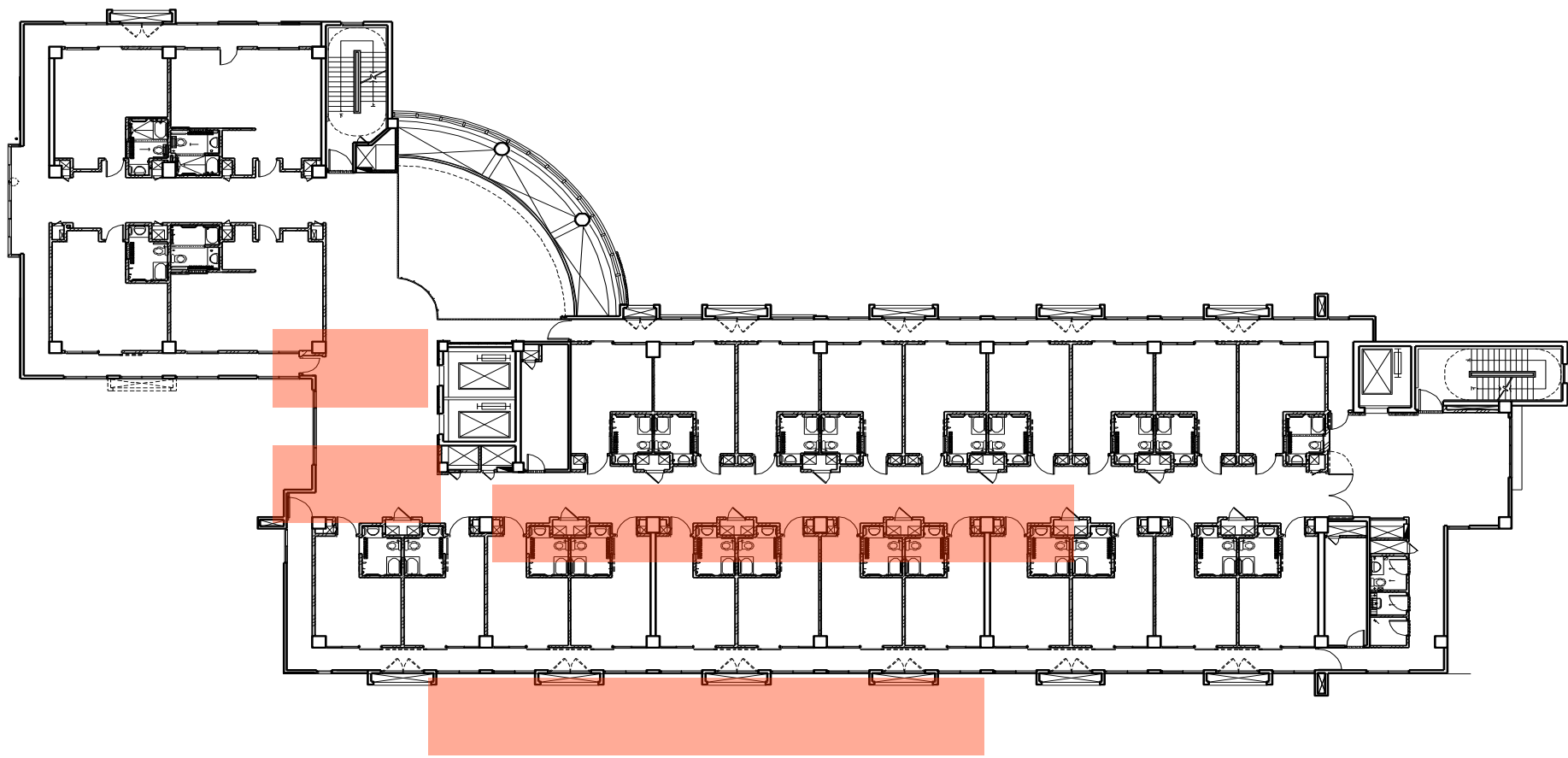

舒適安全的居住空間



1
住民私領域



2
保留個人佈置空間

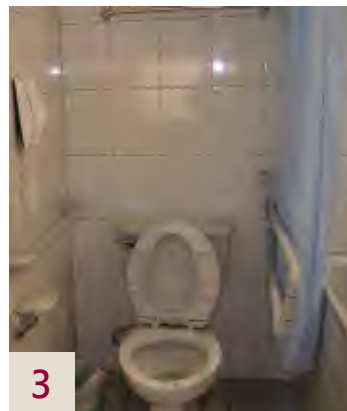

3
扶手符合老人需求

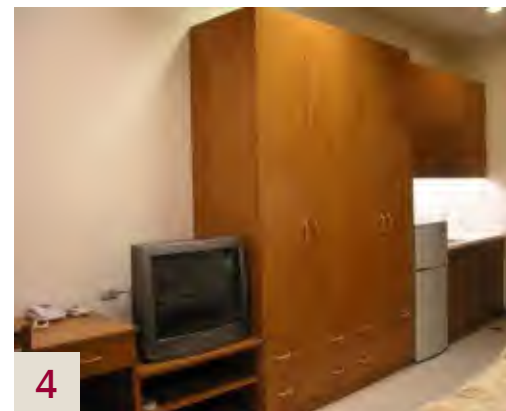

4
衣櫃等機能完整

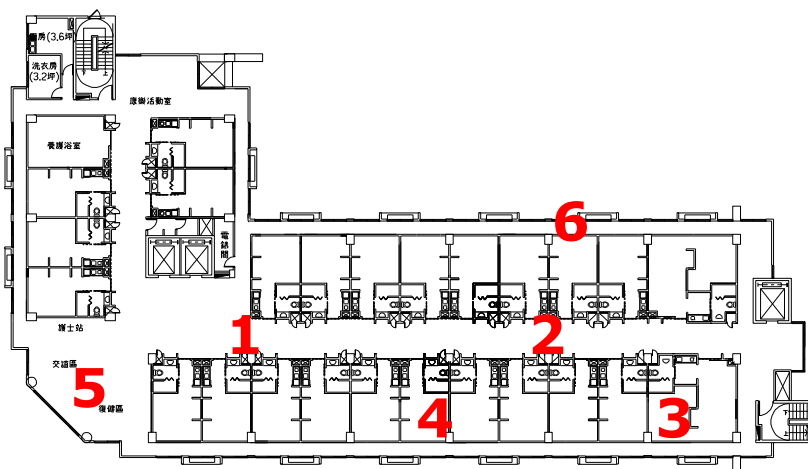

起居交誼空間



5

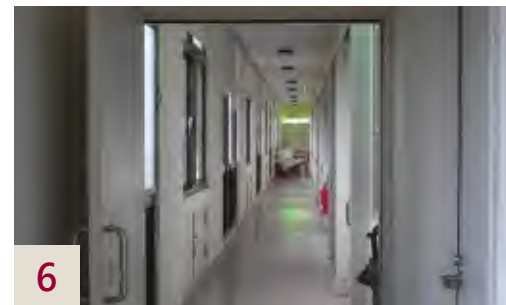

後走道

6

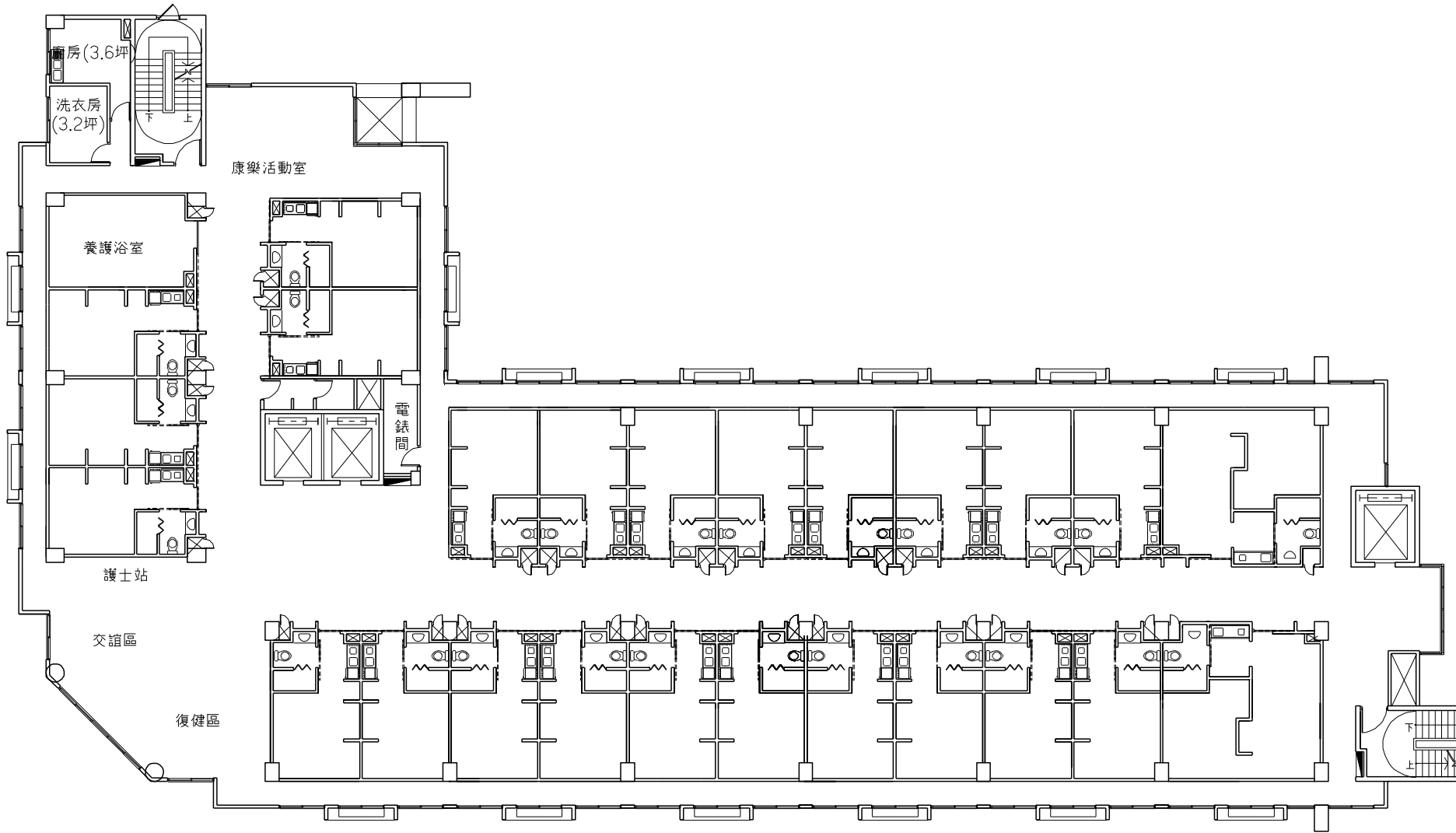

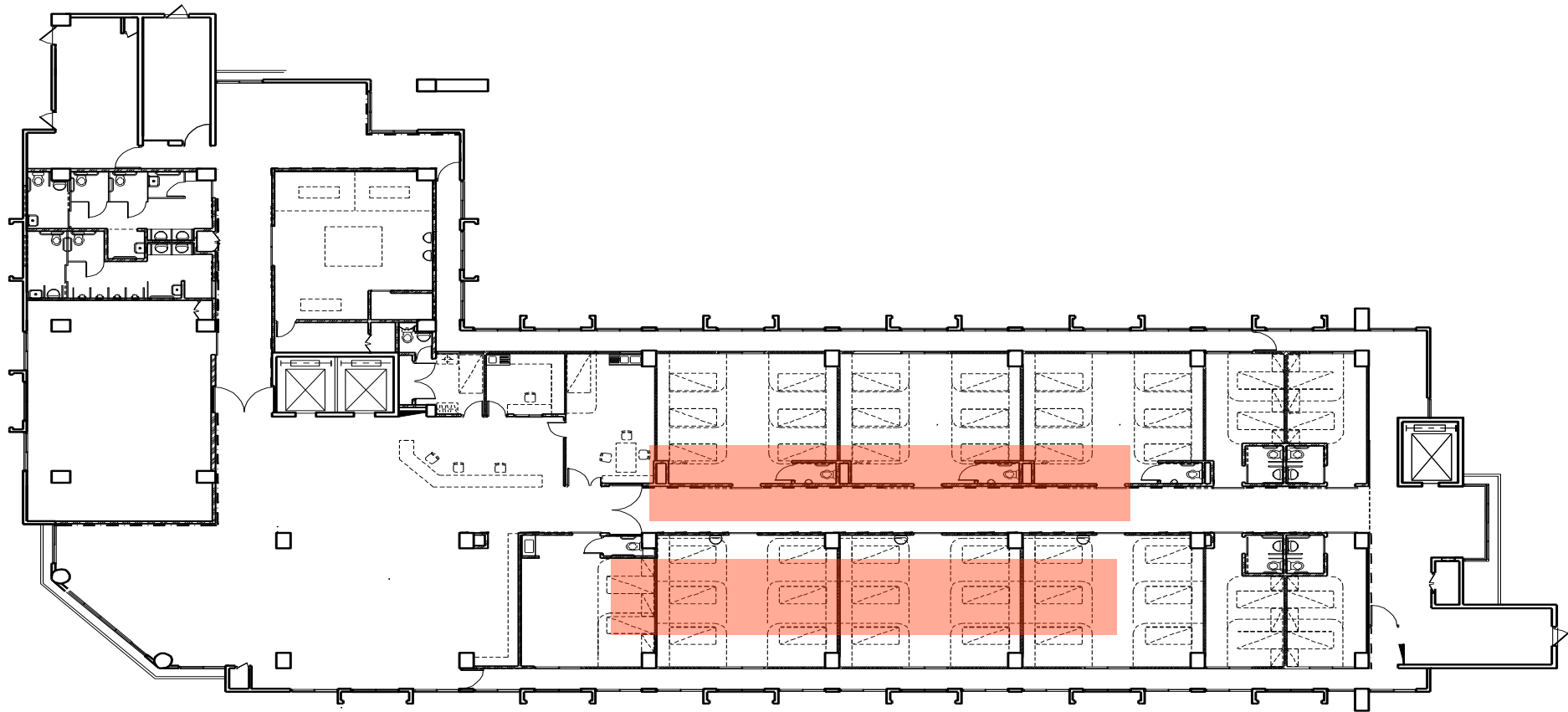

溫馨專業的長照環境

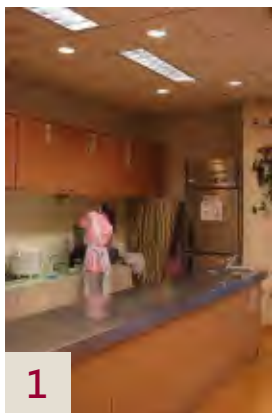

1

配膳及流質飲食處理



2

共同活動區



3

以輪椅為主之用餐區



4

介護浴室

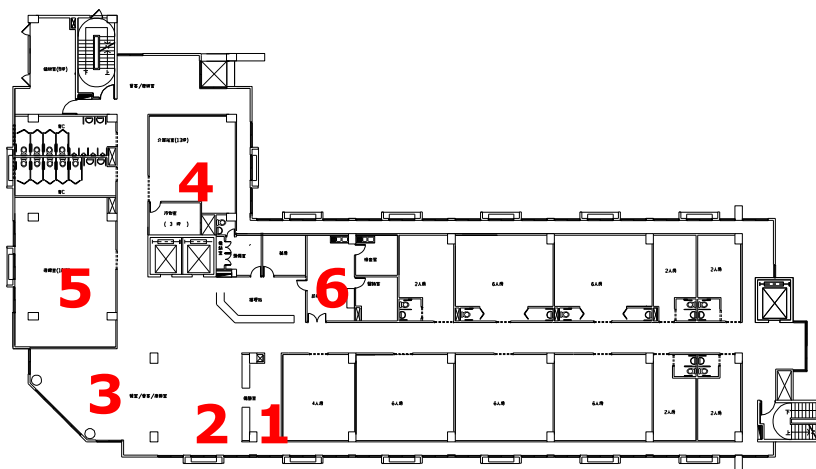

復健室

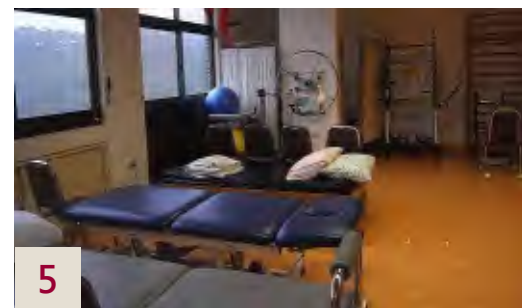

5

溫馨的診療室

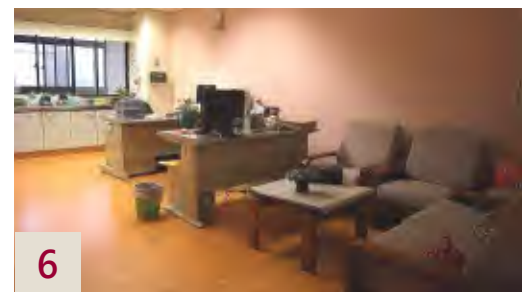

6

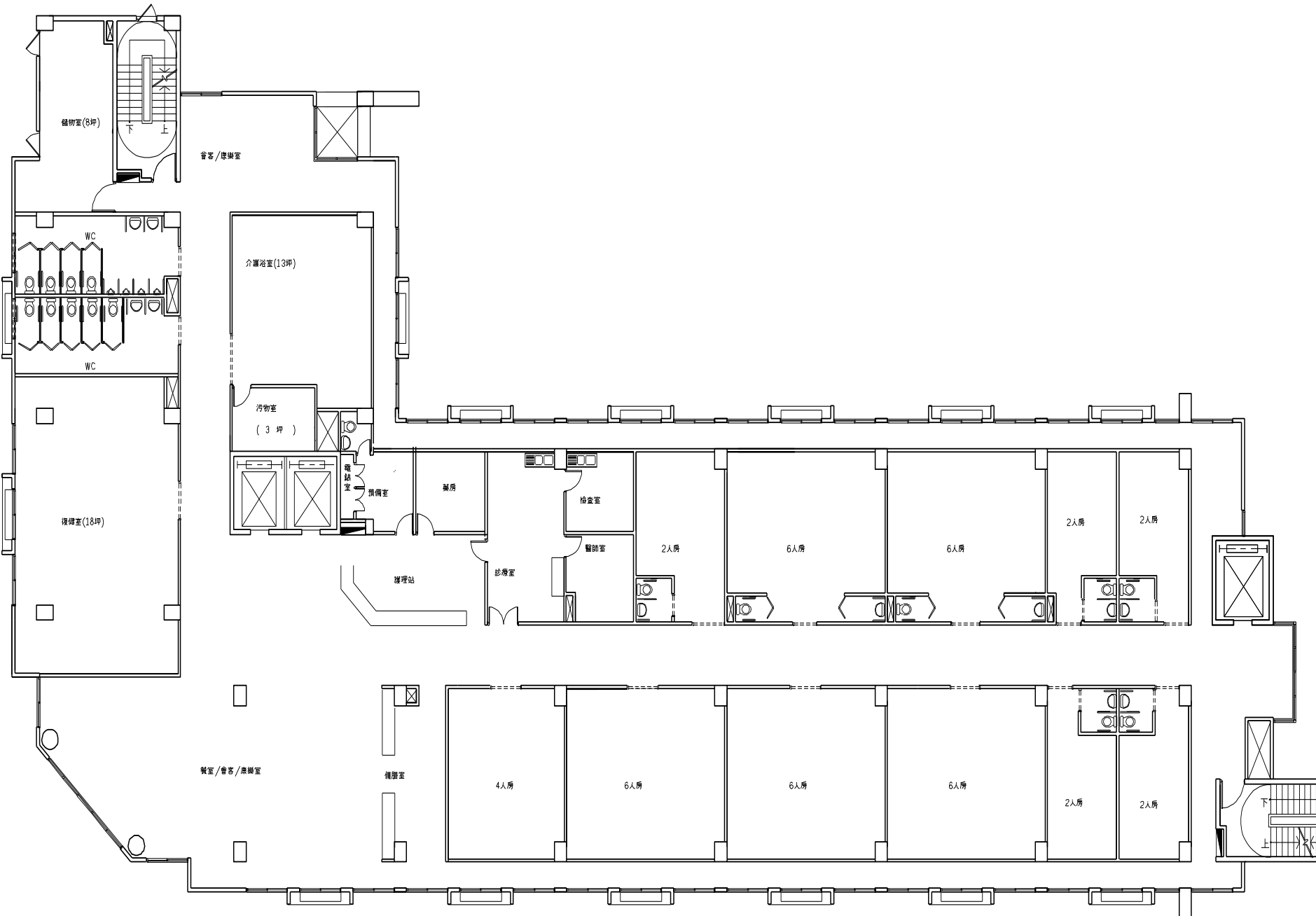

清爽愉悅的用餐環境



1 可看見室外景觀

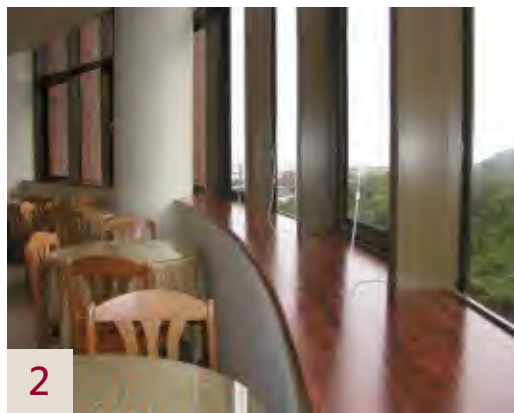

2 窗明几淨容易清潔



可提供各式餐點

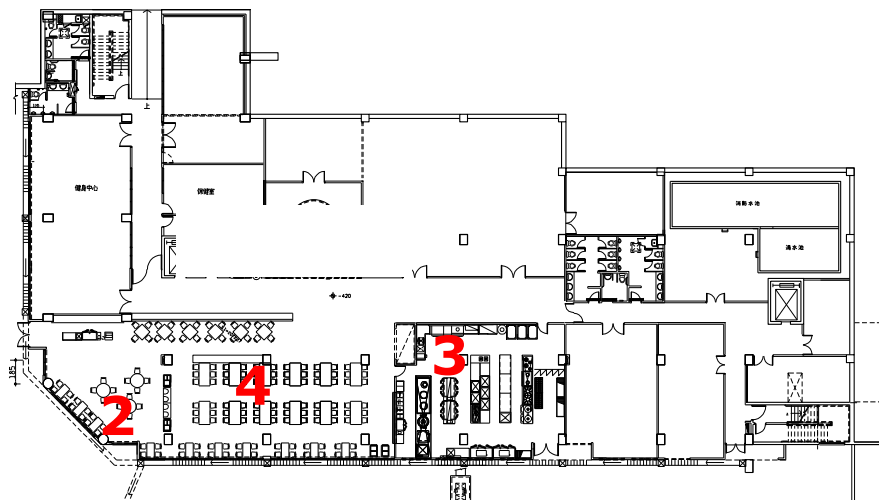

1



4 餐桌高度形式符合輪椅使用

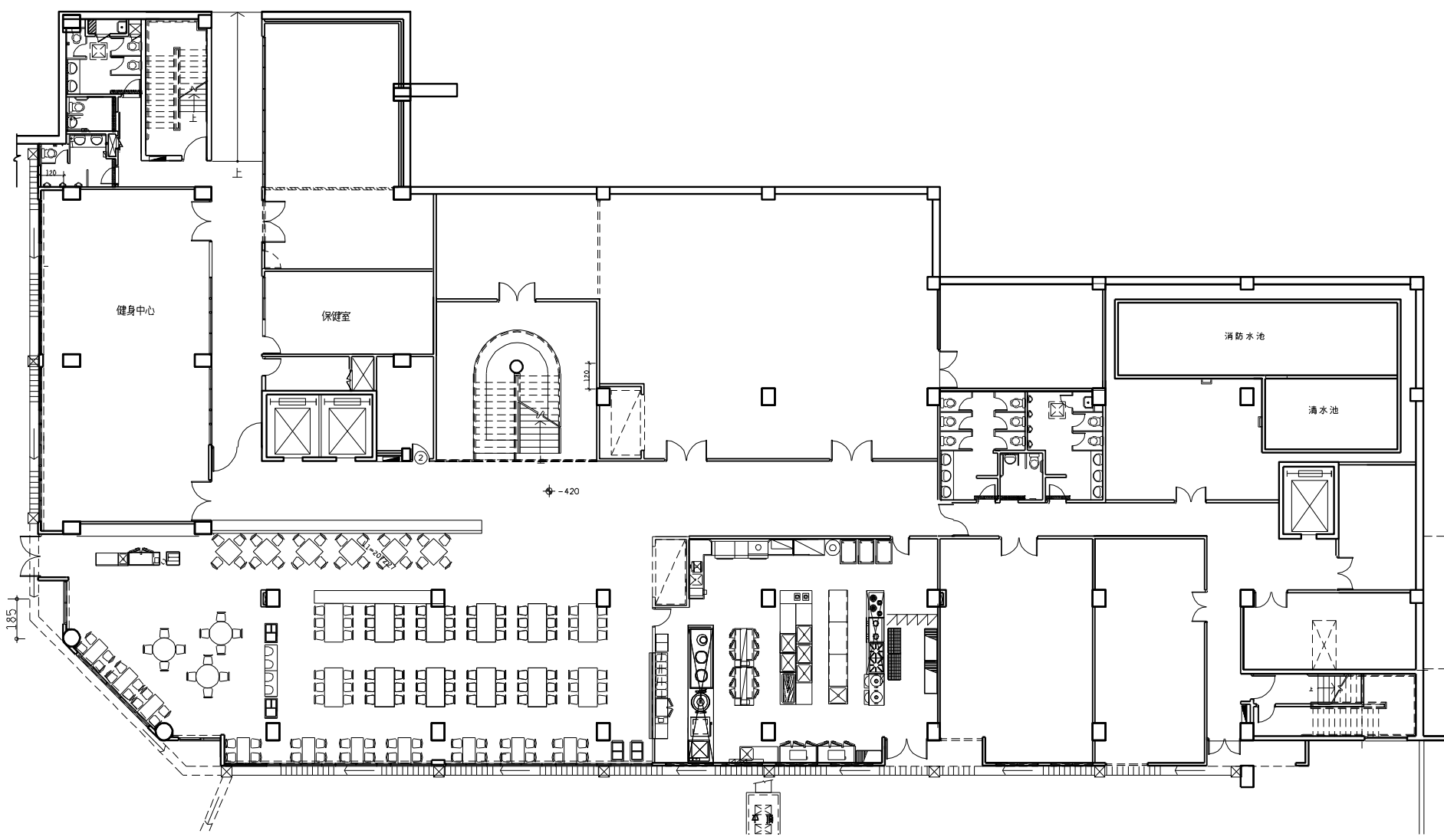

機能豐富的便利生活



1
提款機



2
美容理髮



3
零售販賣



4
才藝教室

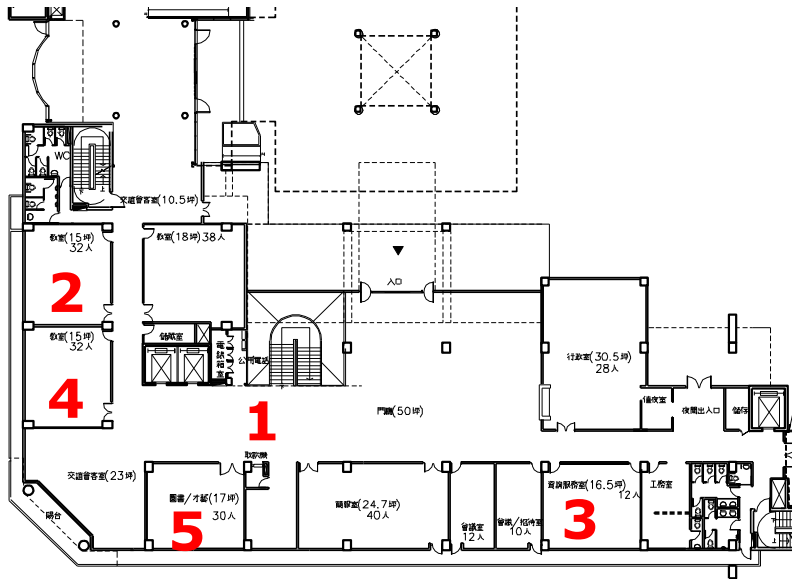

5
圖書、網路、廚房、客房、晒衣場、郵局、信箱、衣物修改間、公共儲藏室、招待所...

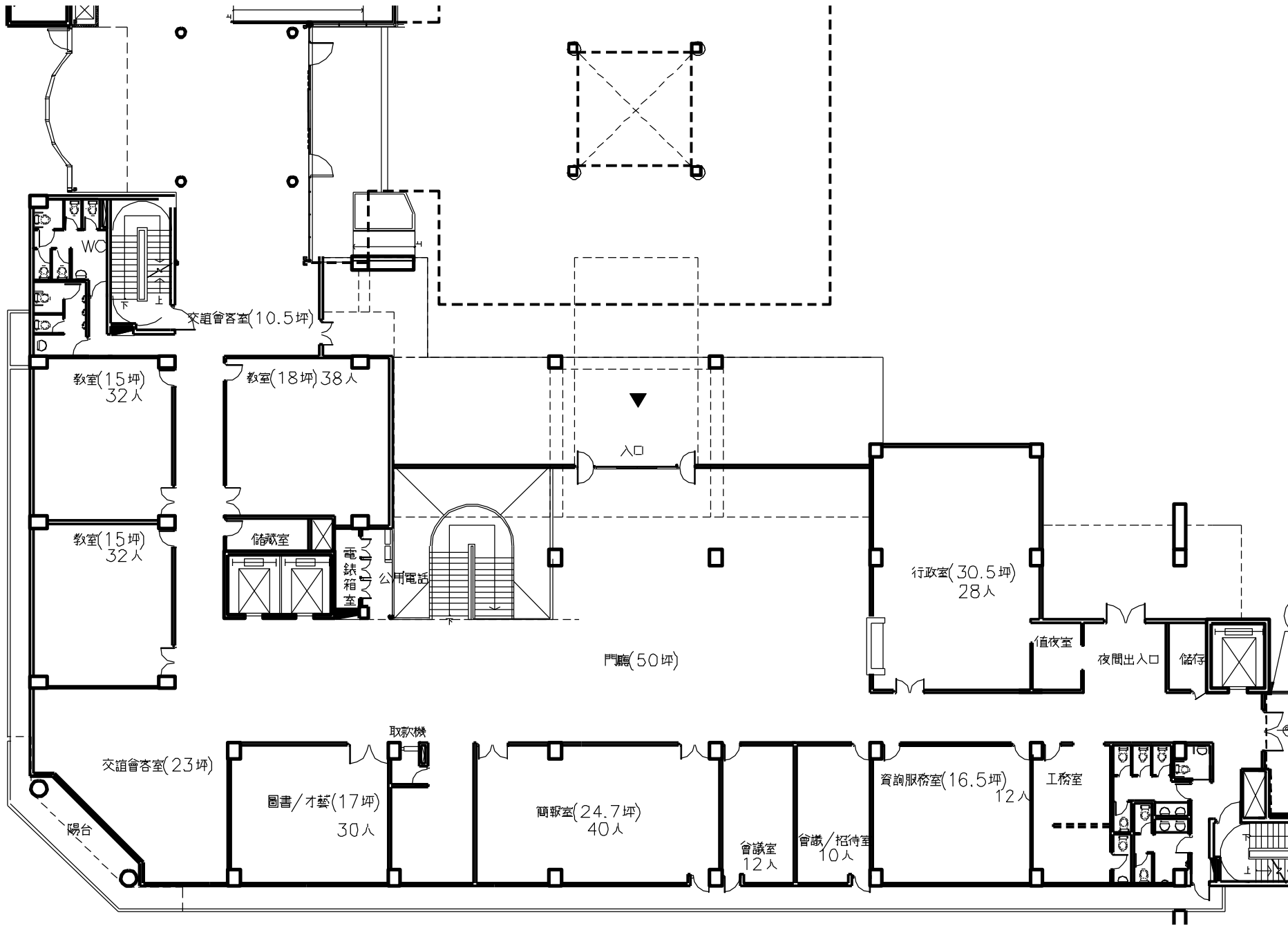

長庚養生文化村



長庚養生文化村



長庚養生文化村



長庚養生文化村



謝謝大家共同關心
未來的環境